

2018 | AIR CONDITIONERS

AIR CONDITIONERS

2 0 1 8

LG HVAC SOLUTION



LG Electronics

<http://www.lg.com>
<http://partner.lge.com>

Copyright © 2018 LG Electronics. All rights reserved.

Distributed by



EUROPE SALES INFRASTRUCTURE

-  Europe B2B Regional Head Office
-  National Sales Office
-  Air Conditioning Academy
-  European Distribution Center
-  Europe Energy Lab
-  Production Site



GLOBAL PRODUCTION SITE



LG Energy Labs in Europe

LG Energy Labs are driven to fulfill the commitment of meeting all the requirements regarding energy efficiency and environmental demands. Each LG Energy Lab is an innovative site dedicated to provide essential commercial and residential products in heating, ventilation and the latest energy efficient air conditioning solutions. Additionally, as a showcase, the LG Energy Lab is equipped with complete monitoring and control systems. The performance of all products are tracked and analyzed by a team of Research and Development engineers based in France, Finland and Korea, ensuring maximum efficiency and reliability during the complete products' lifecycle.



European Air Conditioning Distribution Center

LG's European Air Conditioning Distribution Center is centralised in Oosterhout, the Netherlands. Supplying and delivering products to 15 countries in Europe, this Distribution hub has contributed to quick and seamless delivery, direct shipping for smaller orders and bespoke delivery to air conditioners. The hub tries to manage inventory efficiency by complying with the LG EU's established inventory pool.

TOTAL HVAC SOLUTION PROVIDER

Ever since manufacturing Korea's first exclusively home designed air conditioner in 1968, LG has remained as a pioneer and an epitome of air conditioning innovation. LG has been the world's best selling manufacturer of residential air conditioning solutions. In 2008, LG accomplished the target sales for more than 100 million air conditioners. Encouraged by its success rate and technological leadership in the residential air conditioning sector, LG has expanded its wings into system air conditioning as well.

LG has established itself as an inimitable / exemplary HVAC and energy solution provider, investing in new technologies and adding chillers, VRF systems, and building management systems (BMS) to its comprehensive product portfolio. Including a wide range of innovative solutions, LG delivers unparalleled customer service.

LG produces expert air conditioning professionals at its academic centers, of which there are nearly 80 worldwide. These academic

centers provide workshops and training programs that offer excellent hands-on experience. Additionally, LG provides advanced and highly sophisticated tools for HVAC system engineers and installers, including its time saving LG Air Conditioner Technical Solution (LATS) software. LG also operates several state-of-the-art R&D facilities all across the planet.

One such facility is the Energy Lab, a purpose-built R&D and testing center in northern France. Helping to keep the company ahead of the competition, the scientists and engineers at the Energy Lab study the ramifications of different environmental conditions on LG's products. This in-depth research and analysis enables LG to tune its solutions to the specific environmental demands of each individual market. Combining the best technologies with the intellectual ideas, LG's high quality products have now earned the favoritism of customers in over 100 countries.

INDEX

008 - 155 RESIDENTIAL

014 - 071
WALL MOUNTED

072 - 155
MULTI SPLIT



156 - 261 COMMERCIAL

160 - 261
SINGLE SPLIT



262 - 295 HEATING

264 - 295
THERMA V



R32 REFRIGERANT

HIGHLY EFFICIENT GREEN REFRIGERANT

R32 is environment friendly and classified as a highly efficient 'Go Green' refrigerant.

Reducing Global Warming & Ozone Layer Depletion

The quantity of R32 refrigerant used is appreciably low as compared to the R410A refrigerant. Consequently, this results in decreasing the potential of global warming and minimal depletion of the ozone layer. Comparative case studies of the different refrigerants are indicated in the table and chart as below:

	R410A	R32
Composition	Blend of R32 50% + R125 50%	Pure R32 (No blend)
GWP (Global Warming Potential)	2087.5	675

High Refrigerant Compression Rate

High refrigerant compression rates lead to high capacity as compared to existing refrigerant R12, and R410A.

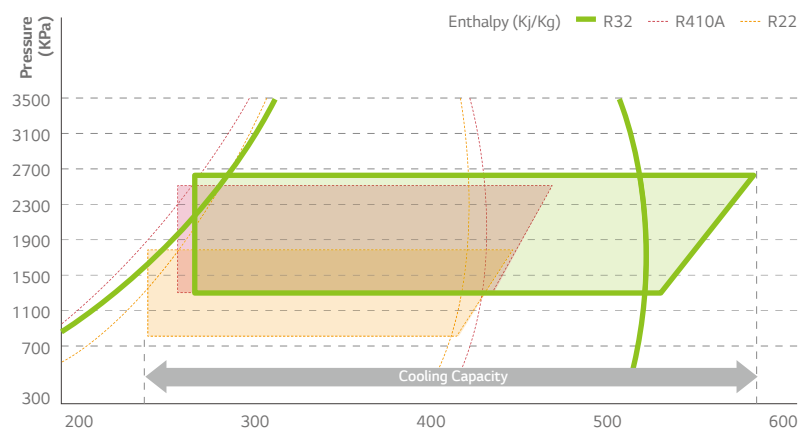

RESIDENTIAL

WALL MOUNTED

MULTI SPLIT



R32 LINE-UP























INDOOR UNIT

○ Single Only ○● Compatible ● Multi Only

		kBtu/h	5	7	9	12	15	18	24
		kW	1.5	2.1	2.6	3.5	4.2	5.3	7.0
Wall Mounted Unit	ARTCOOL			● AM07BP	○● AC09BQ	○● AC12BQ		○● AC18BQ	● AM24BP
	Deluxe			● DM07RP	○● DC09RQ	○● DC12RQ		○● DC18RQ	● DM24RP
	Standard Plus		● PM05SP	● PM07SP	○● PC09SQ	○● PC12SQ	● PM15SP	○● PC18SQ	● PM24SP
			● MJ05PC	● MJ07PC	● MJ09PC	● MJ12PC	● MJ15PC	● MJ18PC	● MJ24PC
Standard				○ S09EQ	○ S12EQ		○ S18EQ		
Ceiling Mounted Cassette	4 Way Cassette		● MT06R	● MT08R	● CT09R	● CT12R		● CT18R	● CT24R
	Mid / High Static Pressure							● CM18R	● CM24R
Ceiling Concealed Duct	Low Static Pressure				● CL09R	● CL12R		● CL18R	● CL24R

OUTDOOR UNIT













○ Single Only ○● Compatible ● Multi Only

		kBtu/h	9	12	14	16	18	21	24	27	30	
		kW	2.6	3.5	4.1	4.7	5.3	6.2	7.0	7.9	8.8	
Single	ARTCOOL											
	Deluxe											
	Standard Plus											
												
Multi	Multi Piping											































R410A LINE-UP

INDOOR UNIT

○ Single Only ○● Compatible ● Multi Only

		kBtu/h	5	7	9	12	15	18	24
		kW	1.5	2.1	2.6	3.5	4.2	5.3	7.0
Wall Mounted Unit	Prestige				○ H09AL	○ H12AL			
	ARTCOOL Stylist				○ G09WL	○ G12WL			
	ARTCOOL Gallery				● MA09AH1	● MA12AH1			
	ARTCOOL			● AM07BP	○● AM09BP	○● AM12BP		○● AM18BP	● AM24BP
	Deluxe			● DM07RP	○● DM09RP	○● DM12RP		○● DM18RP	○● DM24RP
	Standard Plus		● PM05SP	● PM07SP	○● PM09SP	○● PM12SP	● PM15SP	○● PM18SP	○● PM24SP
	Standard				○ P09EN	○ P12EN		○ P18EN	○ P24EN
Ceiling Mounted Cassette	1 Way Cassette				● MT09AH	● MT11AH			
	4 Way Cassette		● MT06AH	● MT08AH	● CT09	● CT12		● CT18	● CT24
Ceiling Concealed Duct	Mid / High Static Pressure							● CM18	● CM24
	Low Static Pressure				● CB09L	● CB12L		● CB18L	● CB24L
Ceiling & Floor Convertible Unit / Ceiling Suspended Unit				● CV09	● CV12		● CV18	● CV24	
Console				● CQ09	● CQ12		● CQ18		

OUTDOOR UNIT

		kBtu/h	9	12	14	16	18	21	24	27	30	40	46	48	57
		kW	2.5	3.5	4.1	4.7	5.3	6.2	7.0	7.9	8.8	11.7	13.5	14.1	16.7
Single	Prestige														
	ARTCOOL Stylist														
	ARTCOOL														
	Deluxe														
	Standard Plus														
	Standard														
Multi	Max 2 IDUs (1Ø)														
	Max 3 IDUs (1Ø)														
	Max 4 IDUs (1Ø)														
	Max 5 IDUs (1Ø)														
	Max 7 IDUs (1Ø, 3Ø)														
	DB Box Type Max 8 IDUs (1Ø, 3Ø)														
Max 9 IDUs (1Ø, 3Ø)															

WALL MOUNTED

Prestige | Artcool | Deluxe | Standard Plus | Standard



WALL MOUNTED

PRESTIGE

DUAL Inverter



LG Prestige offers one of the most comprehensive air conditioning solutions with supreme energy efficiency and providing a tranquil environment.

WALL MOUNTED

ARTCOOL Stylist

Smart Inverter

* This product shall be shortly discontinued.



The design of LG air conditioners is fashionably elegant in such a way that it reigns supreme compared to others. Customise your space.

WALL MOUNTED

ARTCOOL

DUAL Inverter



In addition to modern lines and classic style,
LG ARTCOOL offers the most outstanding
air conditioning solution in a complete and attractive package.

WALL MOUNTED

DELUXE

DUAL Inverter



LG retains it's leading position in supplying RACs,
incorporating the essential and fundamental elements of air conditioner solutions.

WALL MOUNTED

STANDARD PLUS

DUAL Inverter



New Standard Plus is a compact size unit with powerful cooling performance and in intelligible and convenient design.

WALL MOUNTED

STANDARD

DUAL Inverter

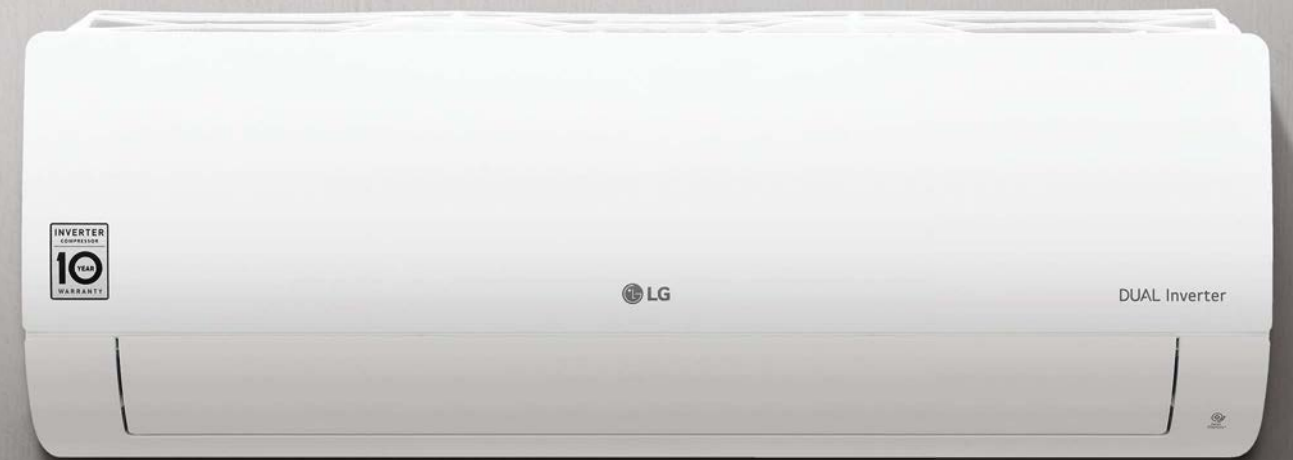

Standard model displays all the sophisticated features of general RAC integrated with LG's more advanced technology.

R410A FEATURE OVERVIEW



Smart Inverter

Energy Efficiency
■ Cooling ■ Heating

		SMART		ENERGY EFFICIENCY		DURABILITY	
		Embedded Wi-Fi	Smart Diagnosis	Active Energy Control	Energy Display	Gold Fin™	
Prestige	9k	●	●	●	●	●	●
	12k						
ARTCOOL Stylist	9k	● ³ (Ready)	●	●	●	●	●
	12k						
ARTCOOL Gallery	9k	●	●	●	●	●	●
	12k						
ARTCOOL	9k	●	●	●	●	●	●
	12k						
	18k						
	7k						
Deluxe	9k	●	●	●	●	●	●
	12k						
	18k						
	24k						
Standard Plus	9k	●	●	●	●	●	●
	12k						
	18k						
	24k						
Standard	9k	● ³ (Ready)	●	●	●	●	●
	12k						
	18k						
	24k						

HEALTH			FAST COOLING & HEATING			COMFORT			
Plasmaster Ionizer ^{PLUS}	Dual Protection Filter	Auto Cleaning	Jet Cool	4 Way Swing	Fast Heating	Comfort Air	Low Noise 19dB	Silent Mode 3dB	Quick & Easy Installation
●	●	●	●	●	●	●	●	●	●
●	●	●	●	● 3 way	●	●	●	●	●
●	●	●	●	● 3 way	●	●	●	●	●
●	●	●	●	●	●	●	● 9,12k Only	●	●
●	●	●	●	●	●	●	● 7k Only	●	●
●	●	●	●	●	●	●	● 9,12k Only	●	●
●	●	●	●	●	●	●	● 9,12k Only	●	●
●	●	●	●	● 2 way	●	●	● 9,12k Only	●	●

W

1. When connected to Multi Outdoor unit, Silent Mode 3dB is working by simply setting the dip switch on the PCB of the outdoor unit.
 2. When combines with 40k Btu, Cooling A+, Heating A
 3. Wi-Fi Ready : can be connected by using Wi-Fi controller (LG-IR-WF-1)



Dual Inverter Compressor

• What is the Dual Inverter Compressor?

A compressor is the heart of an air conditioner, and monitoring whether it works properly, effectively, or noisily that can cause stress as well as cost more money. LG's Dual Inverter Compressor provides an effective solution, resulting in an air conditioner that cools faster, lasts longer, and operates quieter than conventional models.



• How it Works

Varied-Speed Dual Rotary

A compressor motor with a wider rotational frequency that is energy efficient and has a higher volumetric quick cooling capacity than any conventional compressors.



Dual Inverter
COMPRESSOR

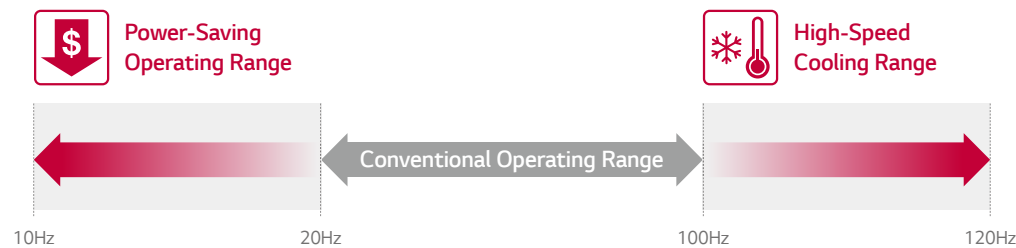

• Product Reliability Improvement

The Dual Inverter Compressor reduces the vibration and with it the sound pressure levels. The reduction in vibration reduces the possibility of fractures occurring in the the surrounding pipework.



R32 Refrigerant

• Pain Point

Due to accelerated global warming and the destruction of the ozone layer, various international conventions and meetings are held to enhance restrictions to the use of refrigerant or enforce the use of eco-friendly refrigerants. In order to reduce environmental destruction, refrigerant R32 is internationally acclaimed for being Eco-friendly. It has the unprecedented feature as a low volume refrigerant that is as efficient as any conventional refrigerant; thus qualifying as a green refrigerant.



• How it Works

Utilising a small amount of the R32 refrigerant also qualifies it to be a highly green efficient system.

Alleviate Global Warming & Ozone Layer Destruction

R32 efficiently works even in small volume compared to existing R410A refrigerant, which decreases potential hazard of global warming.

	R410A	R32
Composition	Blend of R32 50% + R125 50%	Pure R32 (No blend)
GWP (Global Warming Potential)	2087.5	675

High Compressibility

R32's high compressibility rate gives more powerful cooling performance and efficiency compared to existing refrigerant R22 and R410A.

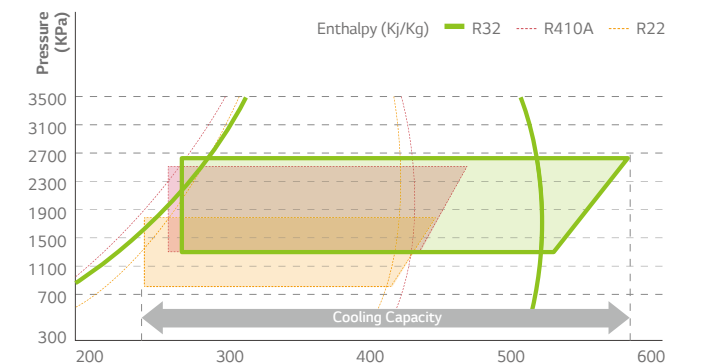

• Benefit

Eco-friendly Refrigerants that can prevent environmental pollution.

High-Efficiency & High-Performance Refrigerant

Reduce refrigerant charge by 15% R410A Preparation for an increase in efficiency for both heating and cooling. R410A Preparation for easy install. (R410A blended refrigerant, R32 single refrigerant)

SMART



Embedded Wi-Fi

Control your air conditioners by using Android or iOS based smartphones. This advanced technology provides you many benefits.

• LG Smart ThinQ



Download the 'LG SmartThinQ' app from the Google Downloads or the Appstore.



LG Smart ThinQ

• How it Works

Embedded Wi-Fi modem

Enable "LG Smart ThinQ" on your air conditioner.



By using the embedded Wi-Fi modem, get ready for innovation without boundaries.



Easy Registration and Log-in

Follow the interactive set-up LG Account steps that will activate smart ThinQ's impressive features.

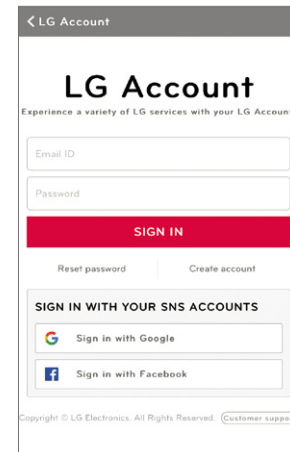

Wi-Fi Connectivity

Each individual member of your family can customise the air conditioner temperature and fan speed accordingly and then save the settings in their app to run it later. These settings can be saved for each air conditioner too.

Multiple Devices



Multi-Control



* Can be controlled by multiple users, but not simultaneously

• Benefit

Simple operation for various functions

On/Off, Current Temp

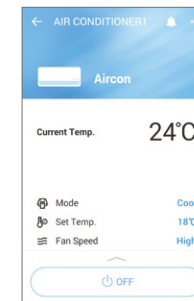

Mode, Set Temp

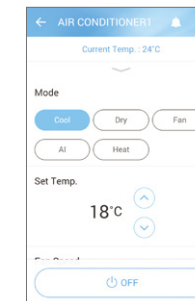

Vane Control

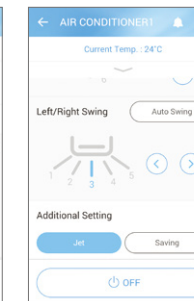
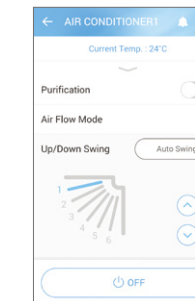

Straight forward Management

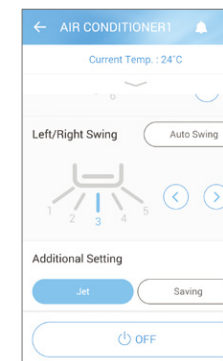

Reservation



Energy Monitoring



Smart Diagnosis



Filter Management

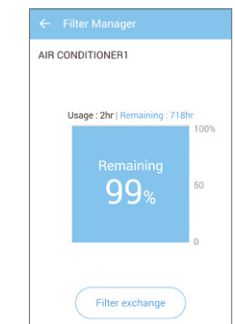

Integrated Home Appliances Control

Control / Monitor all your LG appliances from one place.



Access your air conditioner anytime and from anywhere

with a Wi-Fi equipped device and LG's exclusive control app, Smart ThinQ.



SMART



Smart Diagnosis

Smart Diagnosis allows you to check setup, installation, troubleshooting and other information conveniently from your smartphone.

* Specifications may vary for each model.
* When connected to Multi ODU, Smart Diagnosis function may not be supported.

• What is the Smart Diagnosis?

Smart Diagnosis allows users to conveniently check setup, installation, troubleshooting and other information directly from a smartphone.

* Builds upon widespread smartphone use and offers greater USP diversification
* Perfect for consumers who are unable to view information about their air conditioner via a display or remote control.

• How it works

By using "LG Smart ThinQ" App and clicking "Start Smart Diagnosis," monitor and check diagnosis results conveniently via Wi-Fi.

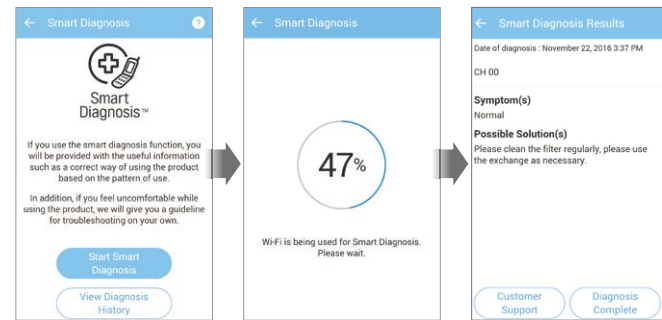

* When the model doesn't provide embedded Wi-Fi, diagnose by buzzer sound with the same app and remote controller.

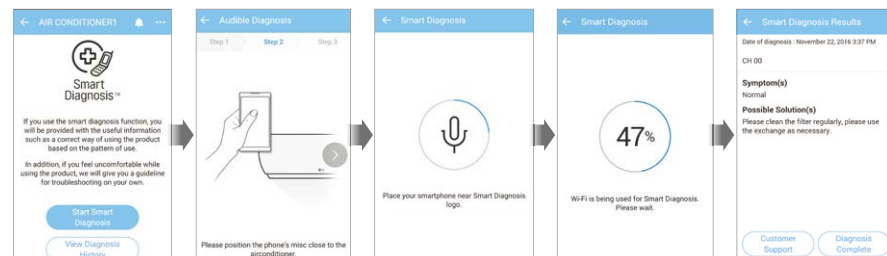

• Benefit

Easily comprehensible error messages make detecting a solution and contacting the service center simple and convenient

For consumer



For Installer and SVC



- Easily check operational status of a product without a display or one that provides limited information
- Save energy by monitoring key operational information and power consumption
- Using the Maintenance Guide helps to improve device performance and increase product life-span.

- Understand the product better by easily confirming operational status and information
- Intuitively diagnose problems by comparing current and past usage data
- Maintain installation capabilities and reduce installation errors by quickly confirming device operational status

SMART



SIMs

By connecting SIMs chip, you can check the status of your air conditioner and diagnose problems from your smartphone.

* Specifications may vary for each model.
* When connected to Multi ODU, SIMs function may not be supported.

• What is the LG SIMs?

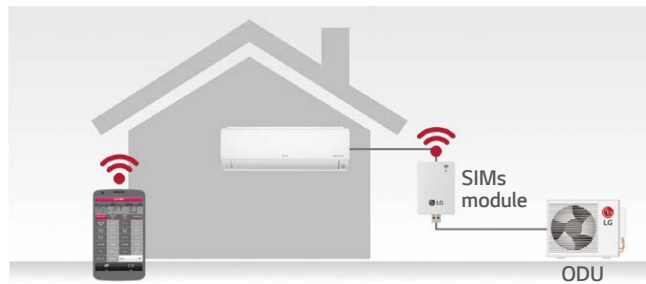

Monitor the status of your air conditioner and accurately diagnose problems by connecting it to a smartphone via a SIMs chip.

* SIMs : Smart Inverter Monitoring System

• How It Works



SIMS App

1. Use a SIMs chip to connect a smartphone to an air conditioner.
2. Monitor and diagnose problems in real time using the SIMs app.

• Benefit

Easy Monitoring

Diagnose problems anytime, anywhere with a SIMs chip.

Easy Diagnosis & Quick Response

Easily monitor IDU/ODU and diagnose problems. Save and review diagnostic data.

<p>Main Current outdoor temperature Indoor temperature Inverter Comp frequency Operating opening Error code / Frequency limits Indoor. Outdoor fan speed</p>	<p>Indoor Unit Indoor Unit Capacity / Operation Mode THM mode / REM mode FAN operating condition / EEV opening Room Temperature / Suction Temperature Intermediate Temperature Exit Temperature</p>
<p>Outdoor Unit Frequency / Fan RPM DC Link / Input Current Input Voltage EEV operation mode Restart timer Compressor mode / EEV opening</p>	<p>Chart Room Temperature Heat exchanger pipe temperature Compressor discharge temperature Frequency / Outdoor temperature Compressor suction temperature Electric current / Voltage</p>

Certificate



*Smartphone Requirements (iOS : 6.1 or later, Android : 2.3 or later)



Low Refrigerant Detection

Early notification of low refrigerant protects your air conditioner from a risk of damage.

* Specifications may vary for each model.
* Depending on the experimental conditions.
* When connected to Multi ODU, Low Refrigerant Detection function may not be supported.

• How It Works

Early Detection of Low Refrigerant Levels

The Air Conditioner is automatically shut down when low refrigerant level is detected.

3 Checkpoints for Low Refrigerant Level :

- 1) The heat exchanger temperature is comparatively cool
- 2) The outdoor unit is working properly
- 3) The energy consumption is working under a standard pattern

If any of the above conditions are not met, for a maximum of 4 times, after 15 minutes of Air Conditioner operation, a Low Refrigerant level is detected and the Air Conditioner is shut down.

Capacity and Effectiveness of the Refrigerant Levels

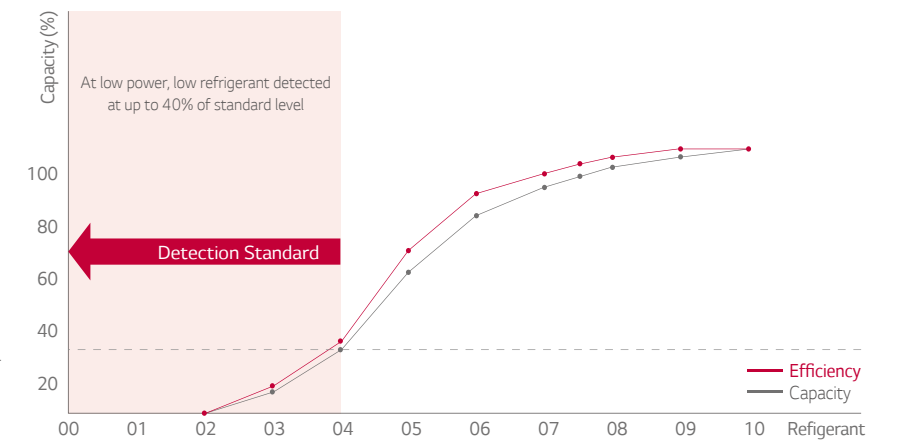

* This function only works under the following conditions:
- Indoor/Outdoor temperature is up to 20 degrees Celsius
- Cooling and dehumidification mode

• Benefit

Longer Lifespan for Air Conditioner

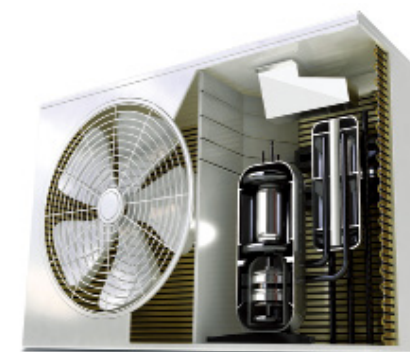

Notify You of Low Refrigerant Levels

When Low Refrigerant Level is detected, it alternately shows CH and 36 on the display.

* Some models show CH and 38 alternately on the display.

ENERGY EFFICIENCY

Supreme Energy Efficiency

LG's revolutionary Inverter technology boasts powerful yet quiet performance while minimising energy consumption. With world class energy efficiency, bask in the cosiness of the atmosphere surroundings whilst saving energy.

* Based on H09AL Model
* Specifications may vary for each model.

High Efficient Compressor and Reversing Valve

Rotary Compressor and Motor Efficiency

The number of suction connections has been reduced from two to one to increase the efficiency of the refrigerant compression during low speed conditions. The DC motor in LG air conditioners remains unsurpassable incomparable to in the world's best efficiencies.

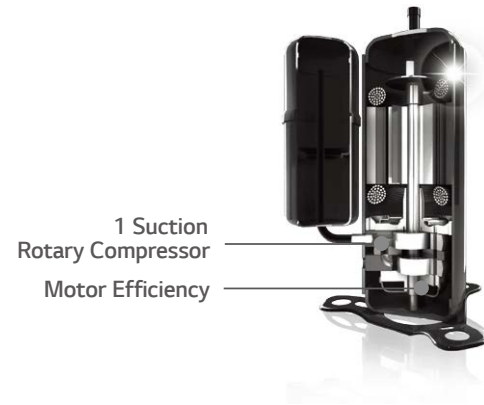

Bi-Stable Reversing Valve

The Input power of 4-way valve has been reduced to 0W by using a Bi-Stable type.

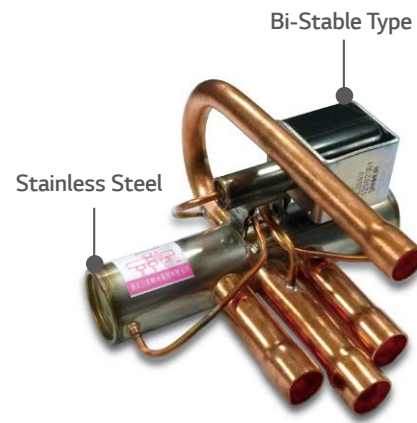

Improved Inverter Drive Efficiency

Used to optimise the time of current flow by controlling the number of converter switching according to energy consumption status. Displays comparatively higher performance and advanced energy efficiency than conventional Inverter air conditioner by reducing power loss with an advanced material component called SiC.

SiC-Hybrid PSC Control

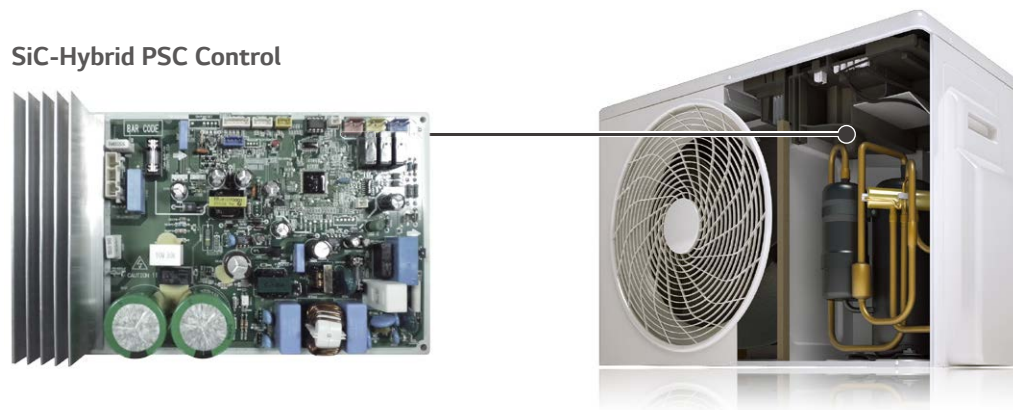

Active Energy Control 4 - Step

LG's Active Energy Control adjusts the energy consumption level and cooling capacity by controlling maximum frequency of the compressor motor.

* Specifications may vary for each model.
* Depending on the experimental conditions.
* When connected to Multi ODU, Active Energy Control function may not be supported.

Concept & Benefit

Cooling a home can come at a high cost particularly during the hot summer months. Avoid those costs and save energy by taking advantage of LG's 4-Step Energy Control System.

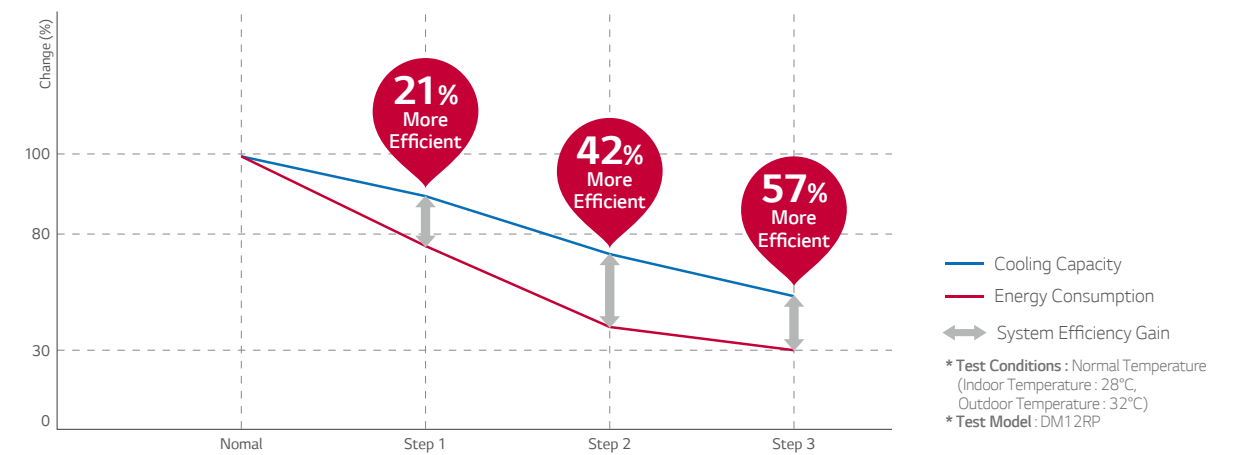

How It Works

<p>Normal. 100% energy usage</p> <p>Many people and high-activity level</p>	<p>Step 1. 80% energy usage</p> <p>Few people and moderate-activity levels.</p> <p>1 Clicks</p>
<p>Step 2. 60% energy usage</p> <p>Fewer people and low-activity levels.</p> <p>2 Clicks</p>	<p>Step 3. 40% energy usage</p> <p>Fewest people with no activity.</p> <p>3 Clicks</p>

ENERGY EFFICIENCY



Energy Display

LG's Energy Display panel monitors the amount of energy levels used. Save on energy consumption while enjoying the cooling by checking your energy level on the panel.

* Specifications may vary for each model.
* When connected to Multi ODU, Energy Display function may not be supported.

• How it Works

Magic Display & Remote Control

With the push of a button on the remote control, indoor unit's LCD display shows the current and total energy use, thus making the users aware of reducing energy consumption.

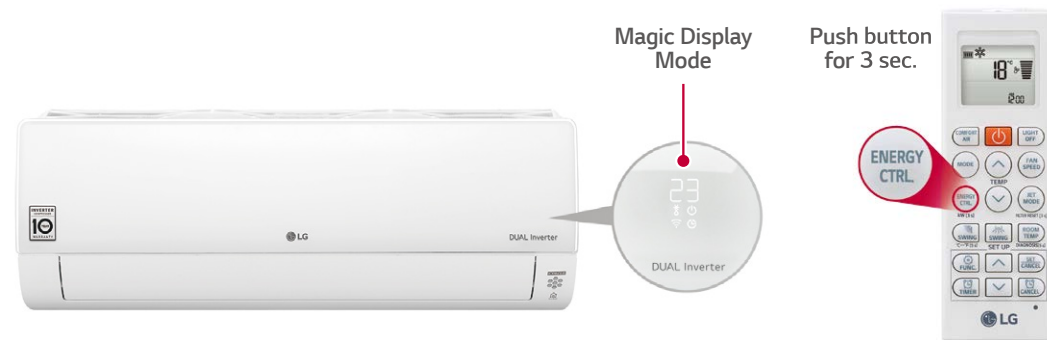

• Benefit

Nomal Mode

Current Setting Temp



Electric Power

Displays Current Energy Use



• Additional Benefit

Fan Speed

Display	Speed
F5	High
F4	Medium-High
F3	Medium
F2	Medium-Low
F1	Low

Sleep Mode



For example, setting 1hr

PERFECT HEALTHCARE



Plasmaster™ Ionizer^{PLUS}

The powerful plasma ionizer protects you from bad odors and harmful and contagious particles in the air with over 3 million ions to sterilize not only the air passing through the air conditioner, but also surrounding surfaces for a safer, and cleaner environment.

* Specifications may vary for each model.
* Depending on the experimental conditions.

• How It Works

Sterilization and Deodorization (Utilizes Over 3 Million Ions)

Plasmaster Ionizer+ reduces harmful and contagious microscopic particles by infusing the air passing through the air conditioner with over 3 million ions.

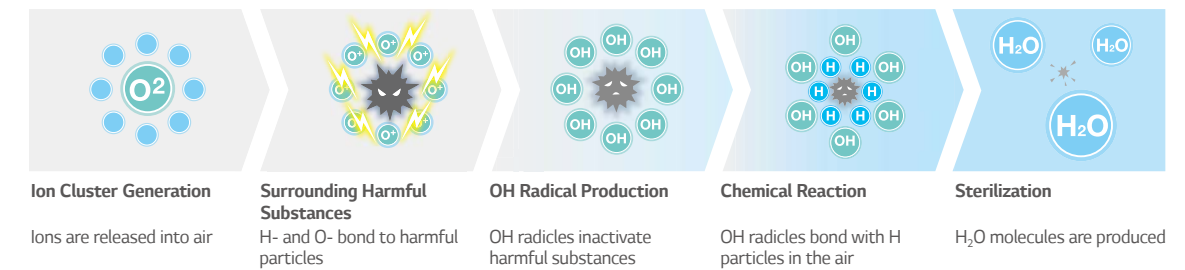

• Test Result

Sterilization Performance Evaluations

Sterilize Bacteria (E.coli colon bacillus) over 99.9% in 30 min.

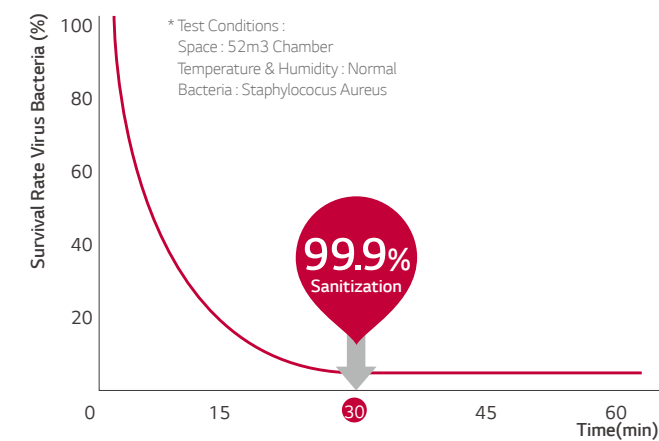

2.1 odor strength decrease in 60 minutes

An odor of measured as 2 European odor units (ouE/m³) or less indicates that the level of odor falls within permissible limits.

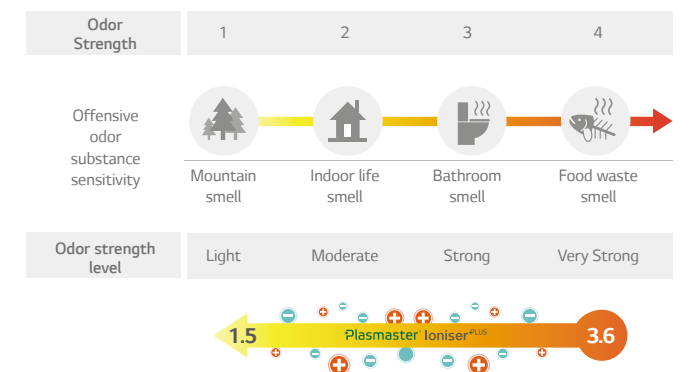

Odor strength reduce 3.6 → 1.5 / The Odor floating in the room as well as curtain and clothes.

PERFECT HEALTHCARE

Dual Protection Filter

The Dual Protection Filter collects dust.

* Specifications may vary for each model.
* Depending on the experimental conditions.

• What is the Dual Protection Filter?

The Dual Protection Filter, designed to capture dust particles over 10µm in size, is the first line of defense and hindrance against finer particles.



• Additional Benefit

Easy to Open

Easily detachable full surface cover helps clean the air conditioner flawlessly.



Easy to Clean

The filter is designed for easy handling and quick cleaning, which lengthens its lifespan.



Auto Cleaning

The interior of the air conditioner is maintained clean by drying off the heat exchanger, then sterilizing the interior once more.

* Specifications may vary for each model.

• Pain Point

The main cause of odor within air conditioners is mold and bacteria growing on the heat exchanger. These germs can spread when the heat exchanger is wet.



• How It Works

Cleans Filter with Regular Airflow

The comprehensive auto cleaning function prevents the formation of bacteria and mold on the heat exchanger, providing an enhancing environment.

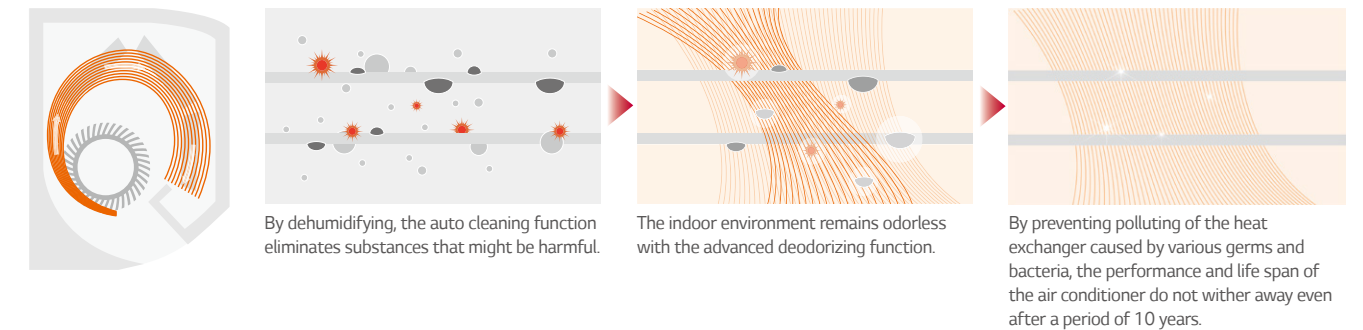

• Benefit

Removes Harmful Particles

Auto Cleaning provides clean air by preventing bacteria, mold and odors that can otherwise accumulate in an indoor unit.



FAST COOLING & HEATING

Fast Cooling

The cool airflow reaches all the corners of the room, keeping the space cool and comfortable.

* Specifications may vary for each model.
* Depending on the experimental conditions.

• How It Works

Bigger Skew Fan

A 25% larger skew fan emanates highly powerful blasts of air.

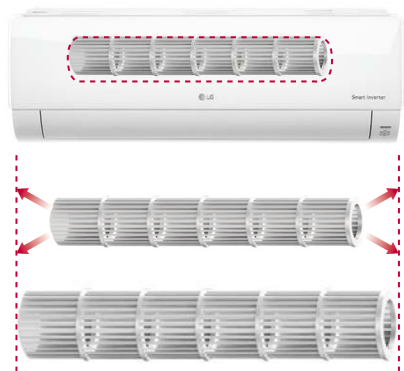

25%
Larger
(Fan Size)

Cooling Outlet

A larger, optimally designed cooling outlet emanates to large areas and cools spaces faster.

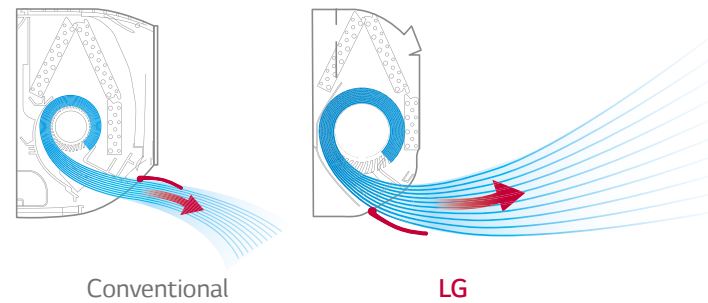

Conventional

LG

• Test Result

Test Result

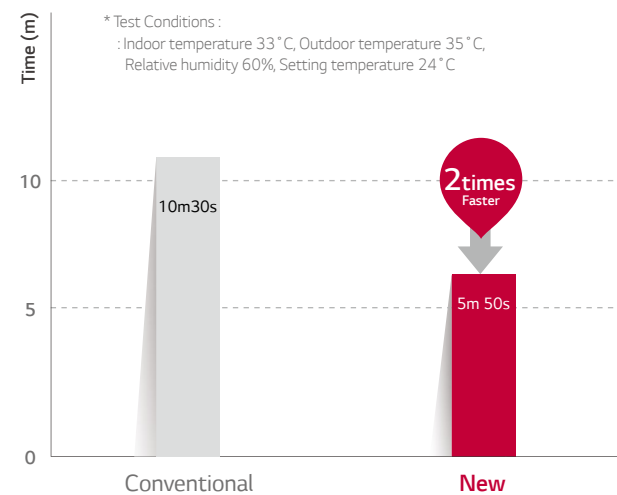

Changes in Temperature Over 30 Minutes

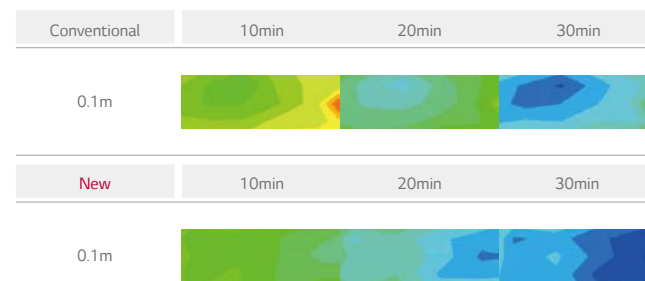

* Test Conditions : Outdoor temperature : 35°C / Indoor temperature : 33°C /
Humidity: 60% / Remote control: 24°C High

Jet Cool

LG air conditioners provide optimized high-speed airflow, which can cool rooms faster while delivering cool air evenly in every direction.

* Specifications may vary for each model.
* Depending on the experimental conditions.

• How It Works

One Click "Jet Mode"

Reduces the temperature of outflowing air to 18°C for 30 minutes with just one click.



• More Powerful Performance

By reducing the second vortex, which decreases airflow within the air outlet, and enlarging the fan size, the amount of airflow is increased to 13.0 CMM.

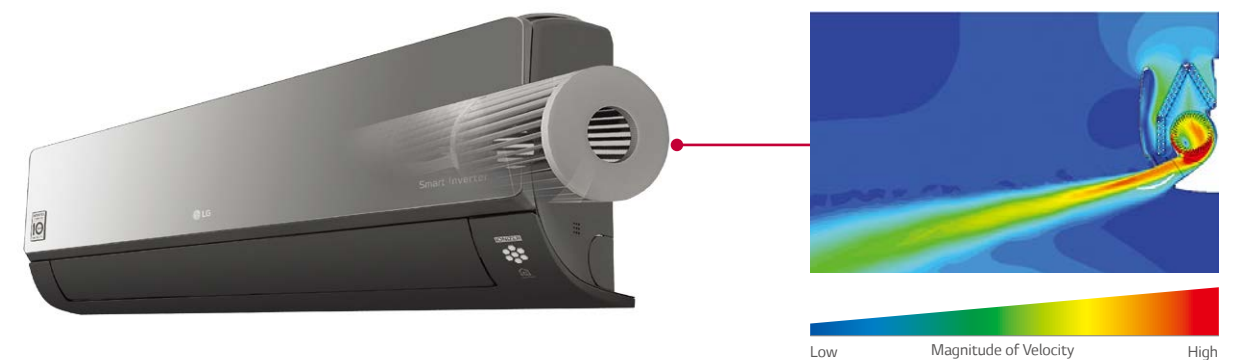

FAST COOLING & HEATING

4-Way Swing

Cool air reaches out to the entire room regardless of where the air conditioner is installed

* Specifications may vary for each model.

• How It Works

6-Step Vane, Control up to 70°

The vertical vane, which moves up and down, has 6 different settings including full-auto swing.

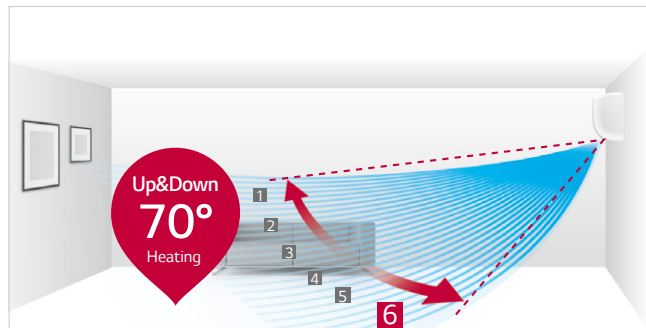

* Angle can be different from each model and working mode.

5-Step Louver, Control up to 55°

The louver, which sways left and right, has 5 different settings including full auto-swing.



• Easy and Simple Control

Airflow direction can be changed by LG ThinQ Wi-Fi app.

Up/Down Swing

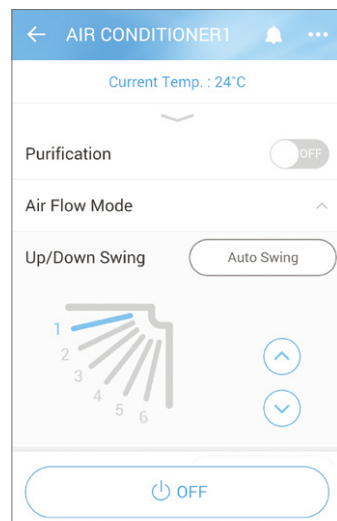

Left/Right Swing

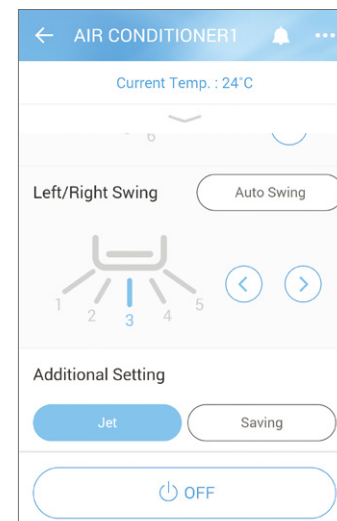

Fast Heating

LG Residential Air Conditioners satisfy your heating needs while consuming less energy, by heating a wider space in a shorter period of time to create a warm and comfortable living environment.

* Specifications may vary for each model.
* Depending on the experimental conditions.

• How It Works

4 way Auto Swing (Easy Airflow Control)

4 Way Auto Swing adjusts airflow based on the surrounding environment, allowing for optimal distribution of warm air to living areas and enabling quick heating.



Vertical Airflow

When heating, the vane sends heated air downwards to maintain a pleasant and balanced room temperature.

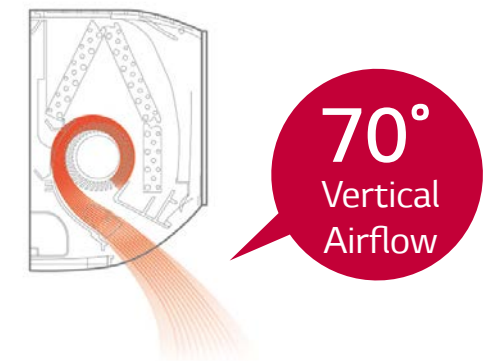

• Benefit & Test Result

22% Quick Heating

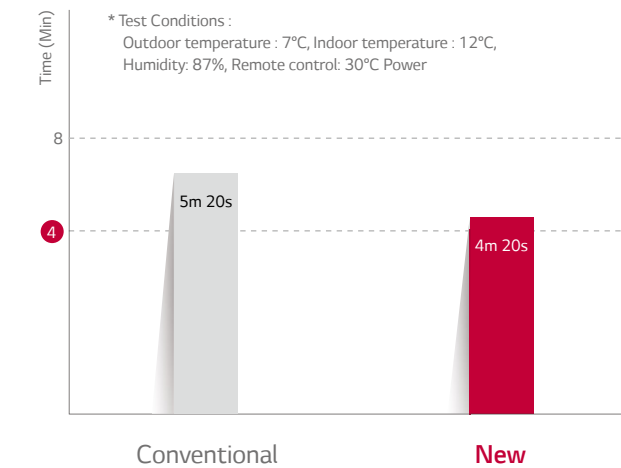

Changes in Temperature Over 20 Minutes

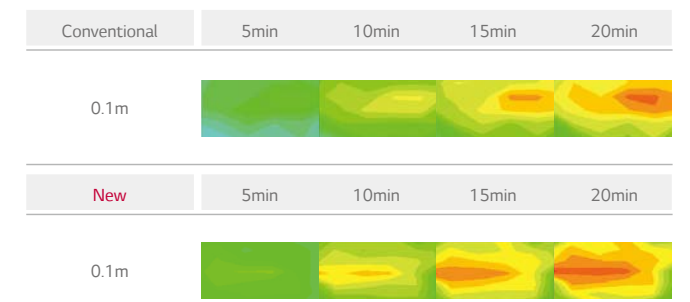

* Test Conditions : Outdoor temperature : 7°C / Indoor temperature : 12°C / Humidity: 87% / Remote control: 30°C Power

EXTREME DURABILITY



10-Year Inverter Compressor Warranty

LG, with confidence in product quality, preserves its better lives for customers by providing 10 years warranty for Inverter Compressor of Air conditioners.

* Specifications may vary for each model.

• What is the 10 Year Warranty?

The compressor is for the Air Conditioner what the engine is to the vehicle. With the 10 year warranty on the compressor, users can avail of the benefits of LG air conditioner for a longer period on time.

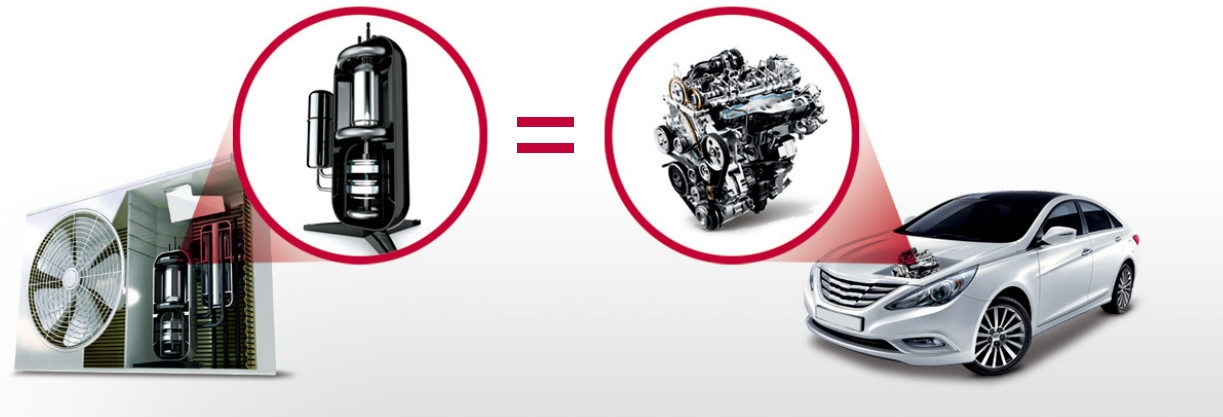

• Benefit & Verification

Reliable Air Conditioner

Product safety is emphasized by offering a 10-year warranty on the compressor to reassure customers about product durability.

Verification

TUV Rheinland, Long Term Accelerated-reliability Test & High Marginal Test

* Long Term Accelerated-Reliability test
 LG's unique testing method with reinforced operating condition for a product life assurance to test and determine the product life cycle in a short period of time by accelerating the life cycle.
 * High Marginal Test
 Test method to secure durability in various adverse conditions that may occur in the field by performing comp reliability test against higher pressure and temperature than the designed range of pressure and temperature which the comp operates in.
 * Verification obtained from TUV Rheinland for 10-year product life cycle



Gold Fin™

The Gold Fin™ coating protects the surface of the heat exchanger from unnecessary wear and corrosion.

* Specifications may vary for each model.
 * Depending on the experimental conditions.

• How It Works

Crosscut View of Heat Exchanger

The gold-colored special coating on the fin of the heat exchanger prevents corrosion, extending the life of the unit.

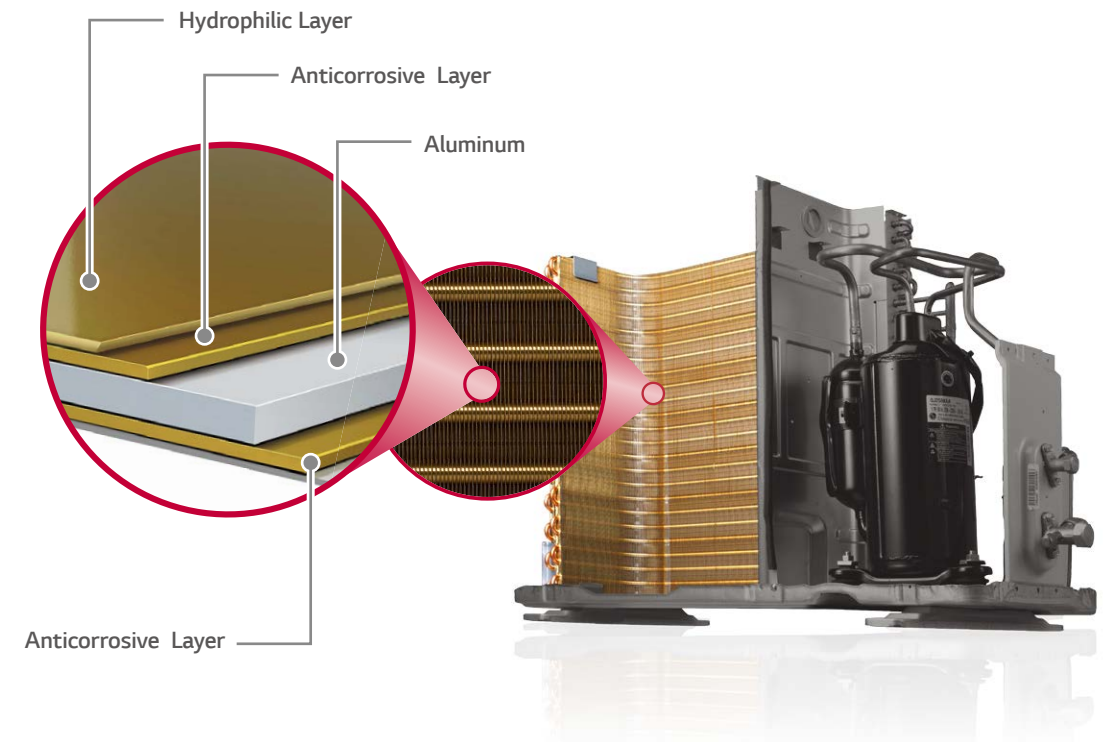

• Test Result

Conventional Fin



Gold Fin™



* Test result 360 hrs. after being exposed to sodium chloride

COMFORT



Comfort Air

LG provides pure hygienic and temperature regulated atmosphere surrounding your living space. An automatic vane angle adjustment sets perfect vane angle and air volume.

* Specifications may vary for each model.

• Concept

If the air conditioner remains ON while asleep, it can lower body temperature or cause discomfort, especially if the outflow of cool air is directly close to the room's occupants. This can be eliminated by the Comfort Air vane angle thus providing a comfortable environment to the sleeping occupants.

• How It Works

Control Panel



Comfort Vane

This option conveniently sets an AC's louvers to a preset position so that outflowing air is directed away from a room's occupants.

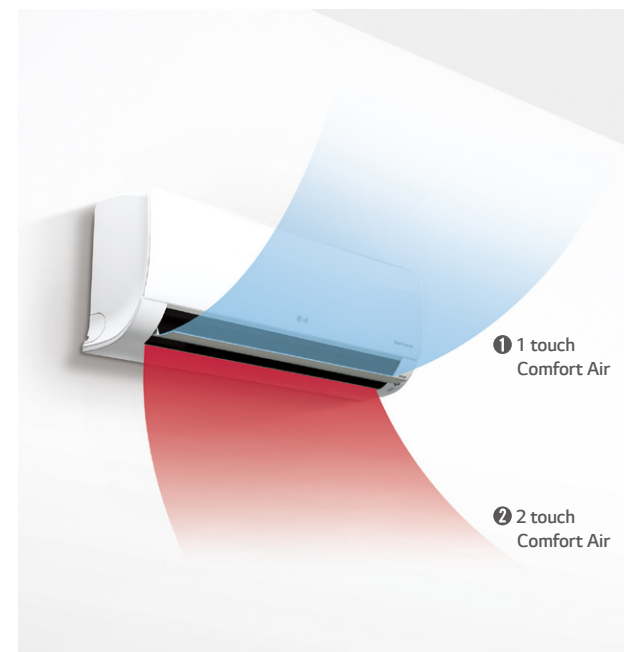

Scene 1: Inclines to a maximum 70° angle.
Sets vane angle to highest position : Optimized for gentle airflow cooling.

Indoor Unit Display



Remote Controller Display

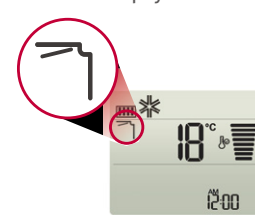

Scene 2: Declines to a maximum 0° angle.
Sets vane angle to lowest position : Optimized for gentle airflow heating.

Indoor Unit Display



Remote Controller Display

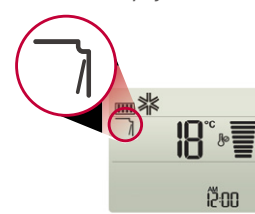

Low Noise

LG Air Conditioners operate at 19dB low noise level, moreover provide healthy soft air by just 1 touch.

* Specifications may vary for each model.

• How It Works

LG's Unique Skew Fan

By minimizing the surface pressure of the fan blade when in contact with the air peak noise are reduced to a level that is among the lowest in the world.

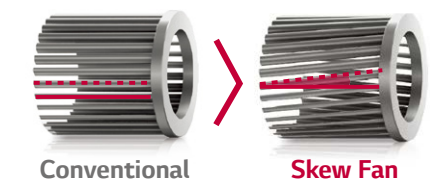

15% Tilted Stabilizer

BLDC Fan Motor

With strong torque and powerful ND magnetism as well as precise speed control of 13 different steps for smooth operation, the BLDC motor provides substantial air volume and high static pressure, while keeping electrical and mechanical noise lower, and making high-speed operation available.

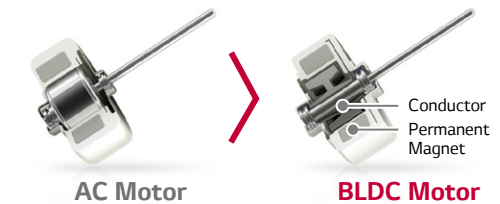

Advanced Motor

- Low Efficiency.
- Heat Problem during overhauling.
- Difficult precise speed control.
- Low Electric and mechanical noise.
- Precise speed control durable.

ALVC (Active Low Vibration Control)

A speed-error component estimates the load to compensate for imbalances, which are the primary causes of vibration and noise, enabling the rotation of the motor without vibration at low Hz levels.

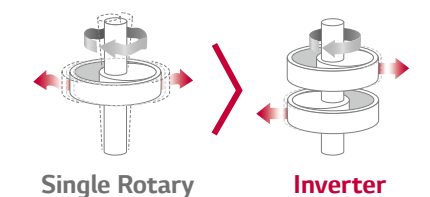

40% Cut Torque Variation

• Benefit

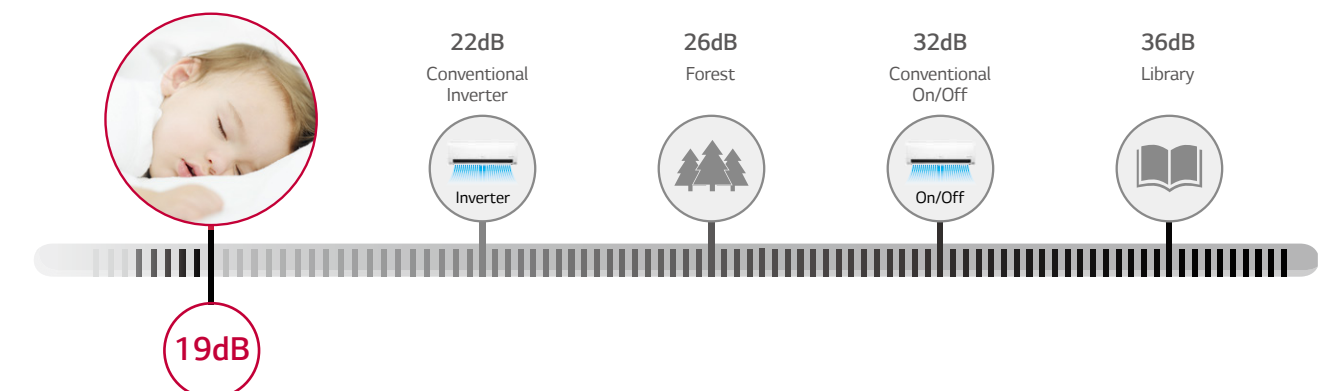

COMFORT

Silent Mode

Silent mode ensures a tranquil and serene experience for the user by reducing noise disturbances while you are resting.

* Specifications may vary for each model.

* Depending on the experimental conditions.

* When connected to Multi Outdoor unit, Silent Mode is working by simply setting the dip switch on the PCB of the outdoor unit.

• How It Works

In Silent Mode, the overall sound level of the outdoor unit drops by up to 3dB and the sound level of the indoor unit also decreases.

Press the Silent Button

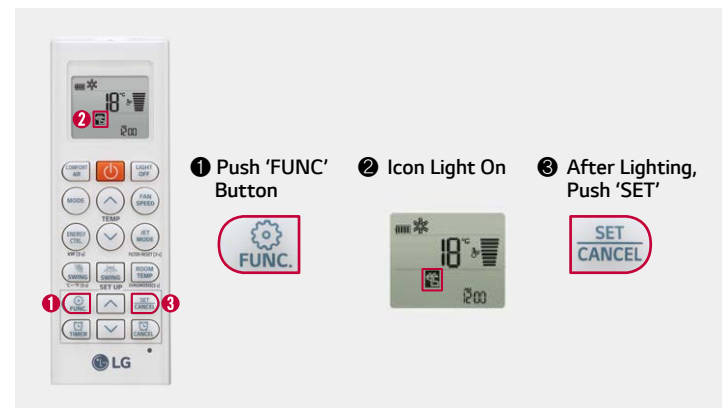

Controls the Outdoor Compressor



• Test Result

Noise Comparison Graph

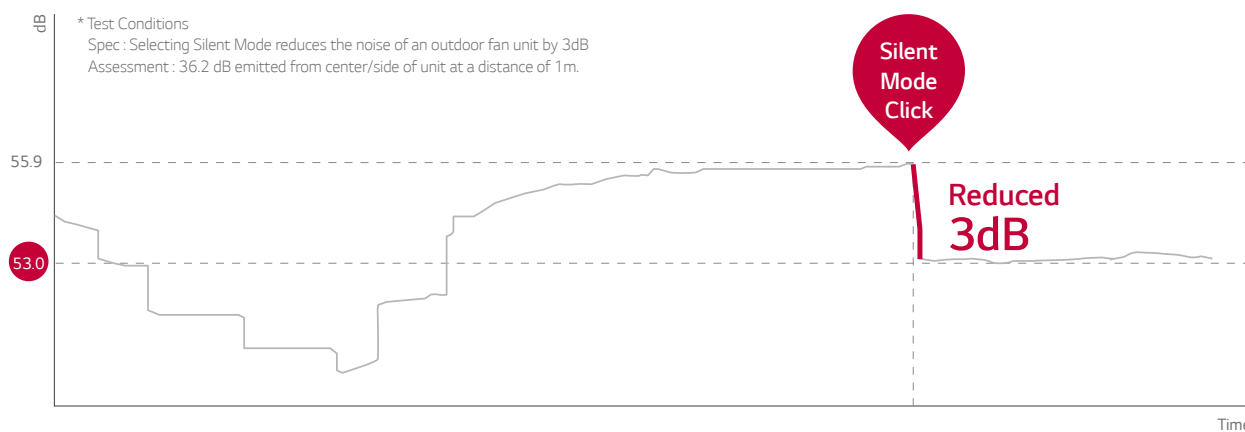

Quick & Easy Installation

LG air conditioner is designed for an easy and efficient installation, making possible to install several units in a short period of time

* Specifications may vary for each model.

• Concept

By reducing the manpower and time required for installation, it is now possible to install more units in less time.

• How It Works

One Simple Packing Box

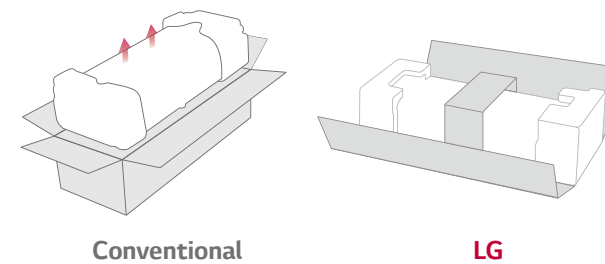

Installation Plate Improvement

LG's installation plate is larger and customized to reduce installation time.

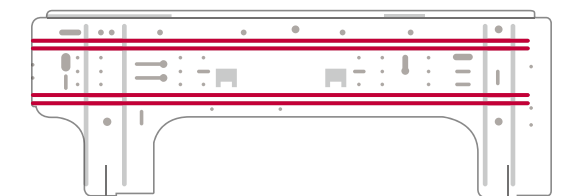

Installation Support Clip

A support clip creates adequate space between the wall and the unit for easier installation.

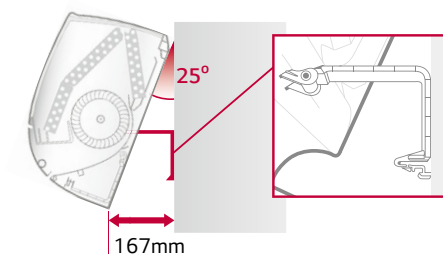

Wider Tubing Space

The space provided for tubing facilitates the whole installation process and hides the unorganized parts, making it appear clean and tidy.

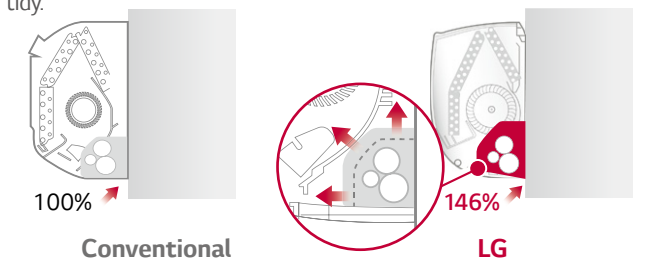

Detachable Bottom Cover

The air conditioner's bottom cover is detachable for easier installation and access.

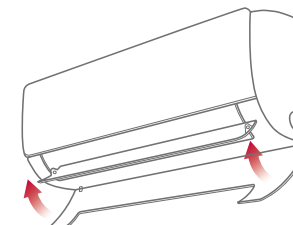

Quick button for running test

The test button is conveniently located and easy to find.

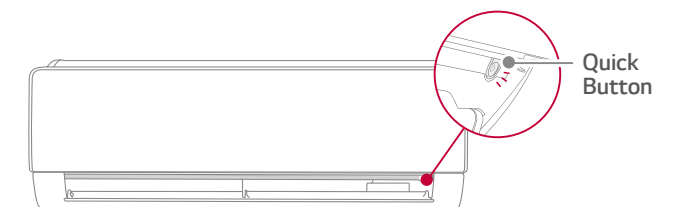

PRESTIGE

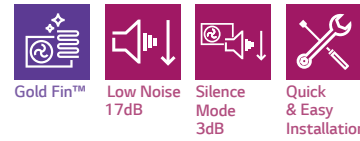

Dual Inverter COMPRESSOR
EUROVENT CERTIFIED PERFORMANCE
 LG participates in the ECP programme for EUROVENT AC program. Check ongoing validity of certification: www.eurovent-certification.com

• Single Combination

UNIT				9K	12K
INDOOR				H09AP.NSM	H12AP.NSM
Capacity	Cooling	Min/Rated/Max	W	300/2500/4000	300/3500/4250
	Heating	Min/Rated/Max	W	300/3200/6900	300/4000/7320
	Heating -7°C	Rated	W	4300	4700
Power Input	Cooling	Rated	W	490	833
	Heating +7°C	Rated	W	593	785
EER			W/W	5.10	4.20
S.E.E.R.				9.4	9.1
P design C			kW	2.5	3.5
COP			W/W	5.4	5.1
S.C.O.P.				5.2	5.1
P design H			kW	3.2	3.8
Energy Label	Cooling (A+++ to D Scale)			A+++	A+++
	Heating (A+++ to D Scale)			A+++	A+++
Annual Energy Consumption	Cooling		kWh	94	135
	Heating		kWh	862	1045
Sound Pressure	Cooling	S/L/M/H	dBA	19/29/37/42	19/29/37/42
	Heating	L/M/H	dBA	29/37/42	29/37/42
Sound Power	Cooling		dBA	60	60
	Heating		dBA	60	60
Air Flow Rate	Cooling	S/L/M/H	m³/min	6.6/8.7/11.1/12.4	6.6/8.7/11.1/12.4
	Max (Power)		m³/min	15.5	15.5
Dehumidification Rate	Heating	L/M/H	m³/min	8.7/11.1/14/3	8.7/11.1/14/3
			l/h	1.5	1.7
Running Current	Cooling	Rated/Max	A	2.5/6.0	3.9/6.0
	Heating	Rated/Max	A	2.9/3.7	7.4/7.4
Starting Current	Cooling	Rated	A	2.5	3.9
	Heating	Rated	A	2.9	3.7
Power Supply			∅ / V / Hz	1 / 220-240 / 50	1 / 220-240 / 50
Circuit Breaker			A	15	15
Power Supply Cable			N x mm²	3*1.0	3*1.0
Power & Transmission Cable			N x mm²	4*1.0 (Including Earth)	4*1.0 (Including Earth)
Dimension			mm	875*295*235	875*295*235
Net Weight			kg	11.0	11.0
Fan Motor Output			W	30	30
OUTDOOR				H09AP.U24	H12AP.U24
Operation Range	Cooling	Min-Max	°CDB	-10-48	-10-48
	Heating	Min-Max	°CDB	-25-24	-25-24
Sound Pressure	Cooling	High	dBA	48	48
	Heating	High	dBA	50	50
Sound Power	Cooling	High	dBA	65	65
	Heating	High	dBA	65	65
Air Flow Rate	Cooling	High	m³/min	49	49
				3	3
Piping	Length (Odu/Idu)	Min	m	20	20
	Elevation (Odu/Idu)	Max	m	10	10
Piping Connection	Liquid	OD(Outside)	mm	6.35	6.35
		OD(Outside)	inch	(1/4)	(1/4)
		OD(Outside)	mm	9.52	9.52
	Gas	OD(Outside)	inch	(3/8)	(3/8)
		OD(Outside)	mm	21.5	21.5
		OD(Outside)	inch	0.85	0.85
Refrigerant	Type			R410A	R410A
	Charge at 7.5m		g	1,150	1,150
Additional charge			t-CO ₂ eq	2.40	2.40
	GWP		g/m	20	20
Fan Motor Output			g/m	2087.5	2087.5
Compressor Type				85	85
Compressor Type				Twin Rotary	Twin Rotary
Net Weight			kg	43	43
Dimension			mm	870*650*330	870*650*330

* This product contains Fluorinated greenhouse gases (R410A).

** S : Sleep / L : Low / M : Medium / H : High

*** Specification, design and feature are subject to change without prior notice.

ARTCOOL STYLIST



LG participates in the ECP programme for EUROVENT AC program. Check ongoing validity of certification: www.eurovent-certification.com

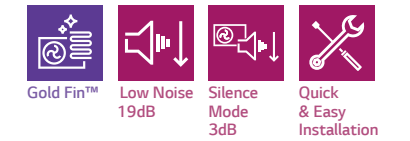

• Single Combination

UNIT				9K	12K
INDOOR				G09WL.NS3	G12WL.NS3
Capacity	Cooling	Min/Rated/Max	W	1300/2500/3500	1300/3500/4000
	Heating	Min/Rated/Max	W	1300/3000/4200	1300/3500/5000
	Heating -7°C	Rated	W	3200	3700
Power Input	Cooling	Rated	W	690	1090
	Heating +7°C	Rated	W	830	970
EER			W/W	3.61	3.21
S.E.E.R.				5.70	5.60
P design C			kW	2.50	3.50
COP			W/W	3.61	3.61
S.C.O.P.				3.80	3.80
P design H			kW	2.70	3.30
Energy Label	Cooling (A++ to E Scale)			A+	A+
	Heating (A++ to E Scale)			A	A
Annual Energy Consumption	Cooling		kWh	170	220
	Heating		kWh	1100	1224
Power Supply			∅ / V / Hz	1/220-240/50	1/220-240/50
Sound Pressure	Cooling	S/L/M/H	dBA	19/29/34/39	19/29/34/39
	Heating	L/M/H	dBA	32/35/39	32/35/39
Sound Power	Cooling	High	dBA	60	60
	Heating	Max (Power)	m³/min	9.7	10.5
Air Flow Rate	Cooling	S/L/M/H	m³/min	4.5/6.0/7.0/8.0	4.5/6.0/7.0/8.0
	Heating	L/M/H	m³/min	6.6/7.5/8.5	6.6/7.5/8.5
Dehumidification Rate			l/h	1.2	1.5
Running Current	Cooling	Rated/Max	A	4.0/6.0	5.0/6.0
	Heating	Rated/Max	A	4.0/7.0	4.5/7.0
Starting Current	Cooling	Rated	A	4.0	5.0
	Heating	Rated	A	4.0	4.5
Circuit Breaker			A	15	15
Power Supply Cable			N x mm²	3*1.0	3*1.0
Power & Transmission Cable			N x mm²	4*1.0(Including Earth)	4*1.0(Including Earth)
Dimension			mm	645*645*121	645*645*121
Net Weight			kg	18	18
Fan Motor Output			W	32.7	32.7
OUTDOOR				G09WL.UL2	G12WL.UL2
Operation Range	Cooling	Min-Max	°CDB	-10-48	-10-48
	Heating	Min-Max	°CDB	-15-24	-15-24
Sound Pressure	Cooling	High	dBA	45	45
	Heating	High	dBA	45	45
Sound Power	Cooling	High	dBA	65	65
	Heating	High	dBA	65	65
Air Flow Rate	Cooling	High	m³/min	33	33
				-	-
Piping	Length (Odu/Idu)	Min	m	15	15
	Elevation (Odu/Idu)	Max	m	10	10
Piping Connection	Liquid	OD(Outside)	mm	6.35	6.35
		OD(Outside)	inch	1/4	1/4
		OD(Outside)	mm	9.52	9.52
	Gas	OD(Outside)	inch	3/8	3/8
		OD(Outside)	mm	21.5	21.5
		OD(Outside)	inch	0.85	0.85
Refrigerant	Type			R410A	R410A
	Charge at 7.5m		g	1000	1000
Additional charge			t-CO ₂ eq	2.09	2.09
	GWP		g/m	20	20
Fan Motor Output			g/m	2087.5	2087.5
Compressor Type				43	43
Compressor Type				Rotary	Rotary
Net Weight			kg	34	34
Dimension			mm	770*545*288	770*545*288

* This product contains Fluorinated greenhouse gases (R410A).

** S : Sleep / L : Low / M : Medium / H : High

*** Specification, design and feature are subject to change without prior notice.

ARTCOOL (R410A)

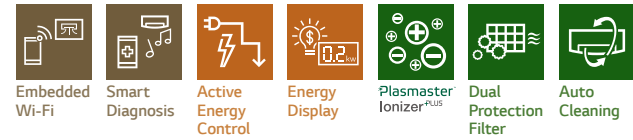

* ARTCOOL models may contain preliminary data
 LG participates in the ECP programme for EUROVENT AC program. Check ongoing validity of certification : www.eurovent-certification.com

• Single Combination

UNIT INDOOR				9K	12K	18K
				AM09BP.NSJ	AM12BP.NSJ	AM18BP.NSK
Capacity	Cooling	Min/Rated/Max	W	890/2500/3700	890/3500/4040	900/5000/5525
	Heating +7°C	Min/Rated/Max	W	890/3200/4100	890/3800/5100	900/5800/6438
Power Input	Heating -7°C	Rated	W	3000	3600	3800
	Cooling	Rated	W	670	1080	1587
EER	Heating +7°C	Rated	W/W	840	1000	1611
	S.E.E.R.			3.73	3.24	3.15
P design C			kW	6.5	6.4	6.5
	COP		W/W	2.5	3.5	5.0
S.C.O.P.			W/W	3.81	3.80	3.60
	P design H		kW	4.0	4.0	4.0
Energy Label	Cooling (A++ to E Scale)			A++	A++	A++
	Heating (A++ to E Scale)			A+	A+	A+
Annual Energy Consumption	Cooling		kWh	134	191	269
	Heating		kWh	840	875	1365
Sound Pressure	Cooling	Sleep	dBA	19	19	31
		Low	dBA	27	27	34
		Medium	dBA	35	35	39
	Heating	High	dBA	41	41	44
		Low	dBA	27	27	34
		Medium	dBA	35	35	39
Sound Power	Cooling	High	dBA	41	41	44
	Heating	High	dBA	41	41	44
Air Flow Rate	Cooling	Sleep	m³/min	3.0	3.0	8.0
		Low	m³/min	4.2	4.2	10.5
		Medium	m³/min	7.5	7.5	13.0
	Heating	High	m³/min	10.0	10.0	14.5
		Max (Power)	m³/min	11.5	12.5	15.5
		Low	m³/min	5.6	5.6	11.0
Dehumidification Rate	Medium	m³/min	7.2	7.2	13.5	
	High	m³/min	10.0	10.0	16.0	
Running Current	Cooling	Rated	A	1.1	1.3	1.8
	Max	A	3.0	4.7	6.9	
Starting Current	Heating	Rated	A	6.0	6.0	9.0
	Max	A	3.7	4.5	7.1	
Power Supply	Cooling	Rated	A	7.0	7.0	9.5
	Max	A	3.0	4.7	6.9	
Circuit Breaker	Heating	Rated	A	3.7	4.5	7.1
	Max	A	3.0	4.7	6.9	
Power Supply Cable	Heating	Rated	A	3.7	4.5	7.1
	Max	A	3.0	4.7	6.9	
Power & Transmission Cable	Heating	Rated	A	3.7	4.5	7.1
	Max	A	3.0	4.7	6.9	
Dimension	Ø / V /Hz			1 / 220-240 / 50	1 / 220-240 / 50	1 / 220-240 / 50
	A			15	15	20
Net Weight	N x mm²			3*1.0	3*1.0	3 x 1.5
	N x mm²			4*1.0 (Including Earth)	4*1.0 (Including Earth)	4 x 1.0 (Including Earth)
Fan Motor Output	mm			837*308*192	837*308*192	998*345*212
	kg			9.9	9.9	13.2
Fan Motor Output	W			30	30	30
	W			30	30	30
OUTDOOR				AM09BPUA3	AM12BPUA3	AM18BPUL2
Operation Range	Cooling	Min-Max	°CDB	-10-48	-10-48	-15-48
	Heating	Min-Max	°CDB	-10-24	-10-24	-10-24
Sound Pressure	Cooling	High	dBA	49	49	53
	Heating	High	dBA	50	50	55
Sound Power	Cooling	High	dBA	65	65	65
	Heating	High	dBA	65	65	65
Air Flow Rate	Cooling	High	m³/min	27	27	35
	Heating	High	m³/min	27	27	35
Piping	Length (Odu/Idu)	Min	m	3	3	3
	Max	m	15	15	20	
Piping Connection	Elevation (Odu/Idu)	Min	m	7	7	10
	Max	m	7	7	10	
Refrigerant	Liquid	OD(Outside)	mm	6.35	6.35	6.35
		inch	(1/4)	(1/4)	(1/4)	
	Gas	OD(Outside)	mm	9.52	9.52	12.7
		inch	(3/8)	(3/8)	(1/2)	
	Drain	OD(Outside)	mm	21.5	21.5	21.5
		inch	OD(Outside)	mm	0.85	0.85
Fan Motor Output	Type			R410A	R410A	R410A
	Charge at 7.5m		g	950	1200	1500
Compressor Type	t-CO ₂ eq		g/m	1.98	1.98	2.51
	Additional charge		g/m	20	20	20
Net Weight	GWP			2087.5	2087.5	2087.5
	W			43	43	43
Dimension	Compressor Type			1P Rotary	1P Rotary	Twin Rotary
	kg			29	29	36.7
Dimension	mm			717*483*230	717*483*230	770*545*288
	mm			717*483*230	717*483*230	770*545*288

* This product contains Fluorinated greenhouse gases (R410A).
 ** S : Sleep / L : Low / M : Medium / H : High
 *** Specification, design and feature are subject to change without prior notice.
 **** Artcool : preliminary specification

ARTCOOL (R32)

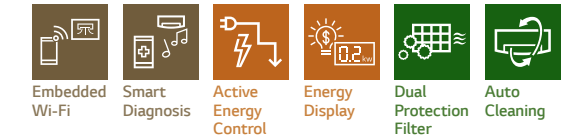

Dual Inverter COMPRESSOR
 EUROVENT CERTIFIED PERFORMANCE
 LG participates in the ECP programme for EUROVENT AC program. Check ongoing validity of certification : www.eurovent-certification.com

• Single Combination

UNIT INDOOR				9K	12K	18K
				AC09BQ.NSJ	AC12BP.NSJ	AC18BP.NSK
Capacity	Cooling	Min/Rated/Max	W	890/2500/3700	890/3500/4040	900/5000/5500
	Heating +7°C	Min/Rated/Max	W	890/3300/4100	890/4000/5100	900/5800/6400
Power Input	Heating -7°C	Rated	W	2600	3000	4200
	Cooling	Rated	W	656	1080	1562
EER	Heating +7°C	Rated	W/W	800	1050	1611
	S.E.E.R.			3.81	3.24	3.20
P design C			kW	7.0	6.6	7.0
	COP		W/W	2.5	3.5	5.0
S.C.O.P.			W/W	4.13	3.81	3.60
	P design H		kW	4.0	4.0	4.3
Energy Label	Cooling (A++ to E Scale)			A++	A++	A++
	Heating (A++ to E Scale)			A+	A+	A+
Annual Energy Consumption	Cooling		kWh	125	186	250
	Heating		kWh	875	875	1270
Sound Pressure	Cooling	Sleep	dBA	19	19	31
		Low	dBA	27	27	34
		Medium	dBA	35	35	39
	Heating	High	dBA	41	41	44
		Low	dBA	27	27	34
		Medium	dBA	35	35	39
Sound Power	Cooling	High	dBA	41	41	44
	Heating	High	dBA	41	41	44
Air Flow Rate	Cooling	Sleep	m³/min	3.0	3.0	8.0
		Low	m³/min	4.2	4.2	10.5
		Medium	m³/min	7.5	7.5	13.0
	Heating	High	m³/min	10.0	10.0	14.5
		Max (Power)	m³/min	12.5	12.5	15.5
		Low	m³/min	5.6	5.6	11.0
Dehumidification Rate	Medium	m³/min	7.2	7.2	13.5	
	High	m³/min	10.0	10.0	16.0	
Running Current	Cooling	Rated	A	1.1	1.3	1.8
	Max	A	3.3	4.7	6.9	
Starting Current	Heating	Rated	A	6.0	6.0	9.0
	Max	A	4.0	4.7	7.1	
Power Supply	Cooling	Rated	A	7.0	7.0	9.5
	Max	A	3.0	4.7	6.9	
Circuit Breaker	Heating	Rated	A	3.7	4.5	7.1
	Max	A	3.0	4.7	6.9	
Power Supply Cable	Heating	Rated	A	3.7	4.5	7.1
	Max	A	3.0	4.7	6.9	
Power & Transmission Cable	Heating	Rated	A	3.7	4.5	7.1
	Max	A	3.0	4.7	6.9	
Dimension	Ø / V /Hz			1 / 220-240 / 50	1 / 220-240 / 50	1 / 220-240 / 50
	A			15	15	20
Net Weight	N x mm²			3*1.0	3*1.0	3 x 1.5
	N x mm²			4*1.0 (Including Earth)	4*1.0 (Including Earth)	4 x 1.0 (Including Earth)
Fan Motor Output	mm			837*308*189	837*308*189	998*345*210
	kg			8.7	8.7	11.9
Fan Motor Output	W			30	30	30
	W			30	30	30
OUTDOOR				AC09BQUA3	AC12BPUA3	AC18BPUL2
Operation Range	Cooling	Min-Max	°CDB	-10-48	-10-48	-15-48
	Heating	Min-Max	°CDB	-10-24	-10-24	-10-24
Sound Pressure	Cooling	High	dBA	48	48	53
	Heating	High	dBA	50	50	55
Sound Power	Cooling	High	dBA	65	65	65
	Heating	High	dBA	65	65	65
Air Flow Rate	Cooling	High	m³/min	27	27	35
	Heating	High	m³/min	27	27	35
Piping	Length (Odu/Idu)	Min	m	3	3	3
	Max	m	15	15	20	
Piping Connection	Elevation (Odu/Idu)	Min	m	7	7	10
	Max	m	7	7	10	
Refrigerant	Liquid	OD(Outside)	mm	6.35	6.35	6.35
		inch	(1/4)	(1/4)	(1/4)	
	Gas	OD(Outside)	mm	9.52	9.52	12.7
		inch	(3/8)	(3/8)	(1/2)	
	Drain	OD(Outside)	mm	21.5	21.5	21.5
		inch	OD(Outside)	mm	0.85	0.85
Fan Motor Output	Type			R32	R32	R32
	Charge at 7.5m		g	700	700	1000
Compressor Type	t-CO ₂ eq		g/m	0.47	0.47	0.68
	Additional charge		g/m	20	20	20
Net Weight	GWP			675	675	675
	W			43	43	43
Dimension	Compressor Type			Twin Rotary	Twin Rotary	Twin Rotary
	kg			25.1	25.1	34.4
Dimension	mm			717*483*230	717*483*230	770*545*288
	mm			717*483*230	717*483*230	770*545*288

* This product contains Fluorinated greenhouse gases (R32).
 ** S : Sleep / L : Low / M : Medium / H : High
 *** Specification, design and feature are subject to change without prior notice.

DELUXE (R410A)

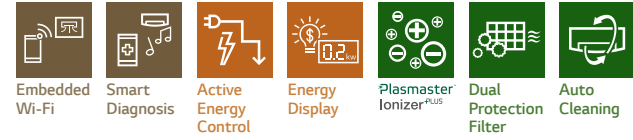

EUROVENT CERTIFIED PERFORMANCE
 LG participates in the ECP programme for EUROVENT AC program.
 Check ongoing validity of certification :
www.eurovent-certification.com



• Single Combination

UNIT		9K		12K		18K		24K	
INDOOR		DM09RPN.SJ		DM12RPN.SJ		DM18RPN.SK		DM24RPN.SK	
Capacity	Cooling	Min/Rated/Max	W	890/2500/3700	890/3500/4040	900/5000/5525	900/6500/7420	900/7500/8640	
	Heating +7°C	Min/Rated/Max	W	890/3200/5000	890/4000/6000	900/5800/6438			
Power Input	Cooling	Rated	W	3200	3800	3800	4850		
	Heating +7°C	Rated	W	556	898	1,562	2,275		
EER			W/W	7.7	3.9	3.2	2.9		
S.E.E.R.			W/W	7.7	7.6	7.0	6.5		
P design C			kW	2.5	3.5	5.0	6.6		
COP			W/W	4.5	4.1	3.60	3.35		
S.C.O.P.			W/W	4.6	4.6	4.2	4.0		
P design H			kW	2.8	2.9	4.1	5.0		
Energy Label	Cooling (A++ to E Scale)			A++	A++	A++	A++		
	Heating (A++ to E Scale)			A++	A++	A+	A+		
Annual Energy Consumption	Cooling		kWh	114	162	250	356		
	Heating		kWh	853	883	1367	1770		
Sound Pressure	Cooling	Sleep	dBA	19	19	31	31		
		Low	dBA	24	24	34	34		
		Medium	dBA	35	35	39	42		
	Heating	High	dBA	40	40	44	47		
		Low	dBA	24	24	34	34		
		Medium	dBA	35	35	39	42		
Sound Power	Cooling	High	dBA	40	40	44	47		
	Heating	High	dBA	60	60	60	65		
Air Flow Rate	Cooling	Sleep	m ³ /min	3.5	3.5	8.0	8.0		
		Low	m ³ /min	5.5	5.5	10.5	10.5		
		Medium	m ³ /min	9.0	9.0	13.0	13.1		
	Heating	High	m ³ /min	11.0	11.0	14.5	16.1		
		Max (Power)	m ³ /min	13.0	13.0	15.5	20.0		
		Low	m ³ /min	6.5	6.5	11.0	11.0		
Dehumidification Rate	Cooling	High	m ³ /min	9.0	9.0	13.5	15.0		
	Heating	High	m ³ /min	11.0	11.0	16.0	18.5		
Running Current	Cooling	Rated	A	2.5	4.0	6.9	10.1		
	Max	A	6.0	6.0	9	14.0			
Starting Current	Cooling	Rated	A	3.2	4.3	7.1	10.4		
	Max	A	7.0	7.0	9.5	14.0			
Power Supply	Cooling	Rated	A	2.5	4.0	6.9	10.1		
	Heating	Rated	A	3.2	4.3	7.1	10.4		
Circuit Breaker			Ø / V /Hz	1 / 220-240 / 50	1 / 220-240 / 50	1 / 220-240 / 50	1 / 220-240 / 50		
Power Supply Cable			A	15	15	20	25		
Power & Transmission Cable			N x mm ²	3*1.0	3*1.0	3 x 1.5	3 x 2.5		
Dimension			N x mm ²	4*1.0 (Including Earth)	4*1.0 (Including Earth)	4 x 1.0 (Including Earth)	4 x 1.0 (Including Earth)		
Net Weight			mm	837*308*189	837*308*189	998*345*210	998*345*210		
Fan Motor Output			kg	8.3	8.3	12	12		
			W	30	30	60	60		
OUTDOOR		DM09RPU.L2		DM12RPU.L2		DM18RPU.L2		DM24RPU.L2	
Operation Range	Cooling	Min-Max	°CDB	-15-48	-15-48	-15-48	-15-48		
	Heating	Min-Max	°CDB	-15-24	-15-24	-10-24	-10-24		
Sound Pressure	Cooling	High	dBA	47	47	53	56		
	Heating	High	dBA	48	48	55	57		
Sound Power	Cooling	High	dBA	65	65	65	70		
	Heating	High	dBA	65	65	65	70		
Air Flow Rate	Cooling	High	m ³ /min	35	35	35	50		
	Heating	High	m ³ /min	3	3	-	-		
Piping	Length (Odu/Idu)	Max	m	20	20	20	30		
	Elevation (Odu/Idu)	Max	m	10	10	10	15		
Piping Connection	Liquid	OD(Outside)	mm	6.35	6.35	6.35	6.35		
		inch	(1/4)	(1/4)	(1/4)	(1/4)			
		Gas	OD(Outside)	mm	9.52	9.52	12.7	15.88	
	Gas	inch	(3/8)	(3/8)	(1/2)	(3/8)			
		inch	(3/8)	(3/8)	(1/2)	(3/8)			
		inch	(3/8)	(3/8)	(1/2)	(3/8)			
Refrigerant	Type			R410A	R410A	R410A	R410A		
	Charge at 7.5m		g	1,000	1,000	1,250	1,350		
Additional charge	t-CO ₂ eq			2.09	2.09	2.61	2.82		
	GWP			20	20	20	30		
Fan Motor Output			W	2087.5	2087.5	2087.5	2087.5		
Compressor Type				43	43	43	85		
Net Weight				1P Rotary	1P Rotary	Twin Rotary	Twin Rotary		
Dimension			kg	30.5	30.5	36.2	46.4		
			mm	770*545*288	770*545*288	770*545*288	870*655*320		

* This product contains Fluorinated greenhouse gases (R410A).

** S : Sleep / L : Low / M : Medium / H : High

*** Specification, design and feature are subject to change without prior notice.

DELUXE (R32)

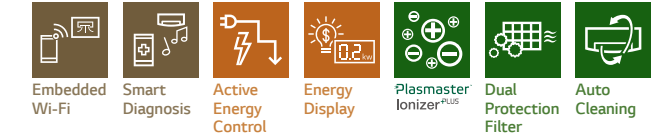
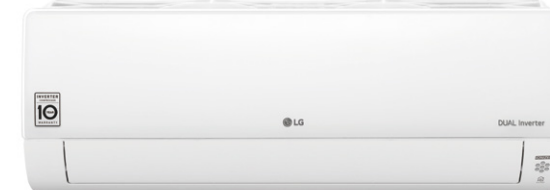

EUROVENT CERTIFIED PERFORMANCE
 LG participates in the ECP programme for EUROVENT AC program.
 Check ongoing validity of certification :
www.eurovent-certification.com



• Single Combination

UNIT		9K		12K		18K	
INDOOR		DC09RQ.NSJ		DC12RQ.NSJ		DC18RQ.NSK	
Capacity	Cooling	Min/Rated/Max	W	890/2500/3700	890/3500/4040	900/5000/5500	900/6500/7400
	Heating +7°C	Min/Rated/Max	W	890/3200/5000	890/4000/6000	900/5800/6400	900/7500/8600
Power Input	Cooling	Rated	W	3200	3500	4200	
	Heating +7°C	Rated	W	572	933	1562	
EER			W/W	7.1	7.6	7.0	
S.E.E.R.			W/W	4.37	3.75	3.20	
P design C			kW	2.5	3.5	5.0	
COP			W/W	4.5	4.1	3.60	
S.C.O.P.			W/W	4.6	4.6	4.3	
P design H			kW	2.8	2.9	3.9	
Energy Label	Cooling (A++ to E Scale)			A++	A++	A++	
	Heating (A++ to E Scale)			A++	A++	A+	
Annual Energy Consumption	Cooling		kWh	111	161	250	
	Heating		kWh	852	883	1270	
Sound Pressure	Cooling	Sleep	dBA	19	19	31	
		Low	dBA	27	27	34	
		Medium	dBA	37	37	39	
	Heating	High	dBA	42	42	44	
		Low	dBA	27	27	34	
		Medium	dBA	37	37	39	
Sound Power	Cooling	High	dBA	42	42	44	
	Heating	High	dBA	60	60	60	
Air Flow Rate	Cooling	Sleep	m ³ /min	3.5	3.5	8.0	
		Low	m ³ /min	5.5	5.5	10.5	
		Medium	m ³ /min	9.0	9.0	13.0	
	Heating	High	m ³ /min	11.0	11.0	14.5	
		Max (Power)	m ³ /min	13.0	13.0	15.5	
		Low	m ³ /min	6.5	6.5	11.0	
Dehumidification Rate	Cooling	High	m ³ /min	9.0	9.0	13.5	
	Heating	High	m ³ /min	11.0	11.0	16.0	
Running Current	Cooling	Rated	A	2.5	4.0	6.9	
	Max	A	6.0	6.0	9.0		
Starting Current	Cooling	Rated	A	3.2	4.3	7.1	
	Max	A	7.0	7.0	9.5		
Power Supply	Cooling	Rated	A	2.5	4.0	6.9	
	Heating	Rated	A	3.2	4.3	7.1	
Circuit Breaker			Ø / V /Hz	1 / 220-240 / 50	1 / 220-240 / 50	1 / 220-240 / 50	
Power Supply Cable			A	15	15	20	
Power & Transmission Cable			N x mm ²	3*1.0	3*1.0	3 x 1.5	
Dimension			N x mm ²	4*1.0 (Including Earth)	4*1.0 (Including Earth)	4 x 1.0 (Including Earth)	
Net Weight			mm	837*308*189	837*308*189	998*345*210	
Fan Motor Output			kg	9.1	9.1	11.9	
			W	30	30	30	
OUTDOOR		DC09RQ.UL2		DC12RQ.UL2		DC18RQ.UL2	
Operation Range	Cooling	Min-Max	°CDB	-15-48	-15-48	-15-48	-15-48
	Heating	Min-Max	°CDB	-15-24	-15-24	-10-24	-10-24
Sound Pressure	Cooling	High	dBA	49	49	53	
	Heating	High	dBA	51	51	55	
Sound Power	Cooling	High	dBA	65	65	65	
	Heating	High	dBA	65	65	65	
Air Flow Rate	Cooling	High	m ³ /min	35	35	35	
	Heating	High	m ³ /min	3	3	3	
Piping	Length (Odu/Idu)	Max	m	20	20	20	
	Elevation (Odu/Idu)	Max	m	10	10	10	
Piping Connection	Liquid	OD(Outside)	mm	6.35	6.35	6.35	
		inch	(1/4)	(1/4)	(1/4)	(1/4)	
		Gas	OD(Outside)	mm	9.52	9.52	12.7
	Gas	inch	(3/8)	(3/8)	(1/2)	(3/8)	
		inch	(3/8)	(3/8)	(1/2)	(3/8)	
		inch	(3/8)	(3/8)	(1/2)	(3/8)	
Refrigerant	Type			R32	R32	R32	
	Charge at 7.5m		g	800	800	1000	
Additional charge	t-CO ₂ eq			0.54	0.54	0.68	
	GWP			20	20	20	
Fan Motor Output			W	675	675	675	
Compressor Type				43	43	43	
Net Weight				Twin Rotary	Twin Rotary	Twin Rotary	
Dimension			kg	34.1	34.1	34.4	
			mm	770*545*288	770*545*288	770*545*288	

* This product contains Fluorinated greenhouse gases (R32).

** S : Sleep / L : Low / M : Medium / H : High

*** Specification, design and feature are subject to change without prior notice.

STANDARD PLUS (R410A)

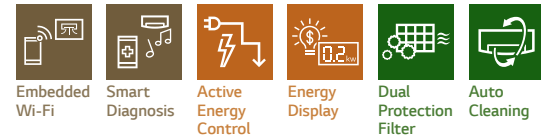

EUROVENT CERTIFIED PERFORMANCE
 LG participates in the ECP programme for EUROVENT AC program.
 Check ongoing validity of certification :
www.eurovent-certification.com



• Single Combination

UNIT		9K		12K		18K		24K	
INDOOR		PM09SP.NSJ		PM12SP.NSJ		PM18SP.NSK		PM24SP.NSK	
Capacity	Cooling	Min/Rated/Max	W	890/2500/3700	890/3500/4040	900/5000/5525	900/6600/7420	900/7500/8640	
	Heating +7°C	Min/Rated/Max	W	890/3200/4100	890/3800/5100	900/5800/6438			
Power Input	Cooling	Rated	W	3000	3600	3800	4850		
	Heating +7°C	Rated	W	670	1080	1587	2275		
EER	Cooling	Rated	W/W	840	1000	1611	2308		
	Heating +7°C	Rated	W/W	3.73	3.24	3.15	2.90		
S.E.E.R.			W/W	6.5	6.4	6.5	6.2		
P design C			kW	2.5	3.5	5.0	6.6		
COP			W/W	3.81	3.80	3.60	3.25		
S.C.O.P.			W/W	4.0	4.0	4.0	3.9		
P design H			kW	2.4	2.5	3.9	5.0		
Energy Label	Cooling (A++ to E Scale)			A++	A++	A++	A++		
	Heating (A++ to E Scale)			A+	A+	A	A		
Annual Energy Consumption	Cooling		kWh	134	191	269	372		
	Heating		kWh	840	875	1365	1794		
Sound Pressure	Cooling	Sleep	dBA	19	19	31	31		
		Low	dBA	27	27	34	34		
		Medium	dBA	35	35	39	42		
	Heating	High	dBA	41	41	44	47		
		Low	dBA	27	27	34	34		
		Medium	dBA	35	35	39	42		
Sound Power	Cooling	High	dBA	41	41	44	47		
	Heating	High	dBA	59	59	60	65		
Air Flow Rate	Cooling	Sleep	m ³ /min	3.0	3.0	8.0	8.0		
		Low	m ³ /min	4.2	4.2	10.5	10.5		
		Medium	m ³ /min	7.5	7.5	13.0	13.1		
	Heating	High	m ³ /min	10.0	10.0	14.5	16.1		
		Max (Power)	m ³ /min	11.5	12.5	15.5	20.0		
		Low	m ³ /min	5.6	5.6	11.0	11.0		
Dehumidification Rate	Cooling	High	m ³ /min	7.2	7.2	13.5	15.0		
	Heating	High	m ³ /min	10.0	10.0	16.0	18.5		
Running Current	Cooling	Rated	A	3.0	4.7	6.9	10.1		
	Heating	Rated	A	6.0	6.0	9.0	14.0		
Starting Current	Cooling	Max	A	3.7	4.5	7.1	10.4		
	Heating	Max	A	7.0	7.0	9.5	14.0		
Power Supply	Cooling	Rated	A	3.0	4.7	6.9	10.1		
	Heating	Rated	A	3.7	4.5	7.1	10.4		
Circuit Breaker			Ø / V /Hz	1 / 220-240 / 50	1 / 220-240 / 50	1 / 220-240 / 50	1 / 220-240 / 50		
Power Supply Cable			A	15	15	20	25		
Power & Transmission Cable			N x mm ²	3*1.0	3*1.0	3 x 1.5	3 x 2.5		
Dimension			N x mm ²	4*1.0 (Including Earth)	4*1.0 (Including Earth)	4 x 1.0 (Including Earth)	4 x 1.0 (Including Earth)		
Net Weight			mm	837*308*189	837*308*189	998*345*210	998*345*210		
Fan Motor Output			kg	8.7	8.7	12.0	12.8		
			W	30	30	30	60		
OUTDOOR		PM09SP.UA3		PM12SP.UA3		PM18SP.UL2		PM24SP.UUE	
Operation Range	Cooling	Min-Max	°CDB	-10-48	-10-48	-15-48	-15-48		
	Heating	Min-Max	°CDB	-10-24	-10-24	-10-24	-10-24		
Sound Pressure	Cooling	High	dBA	49	49	53	56		
	Heating	High	dBA	50	50	55	57		
Sound Power	Cooling	High	dBA	65	65	65	70		
	Heating	High	dBA	65	65	65	70		
Air Flow Rate	Cooling	High	m ³ /min	27	27	35	50		
	Heating	High	m ³ /min	27	27	35	50		
Piping	Length (Odu/Idu)	Min	m	3	3	3	3		
	Elevation (Odu/Idu)	Max	m	15	15	20	30		
Piping Connection	Liquid	OD(Outside)	mm	6.35	6.35	6.35	6.35		
		inch	(1/4)	(1/4)	(1/4)	(1/4)			
	Gas	OD(Outside)	mm	9.52	9.52	12.7	15.88		
		inch	(3/8)	(3/8)	(1/2)	(3/8)			
	Drain	OD(Outside)	mm	21.5	21.5	21.5	21.5		
		inch	OD(Outside)	mm	0.85	0.85	0.85	0.85	
Refrigerant	Type			R410A	R410A	R410A	R410A		
	Charge at 7.5m		g	950	1200	1350	1500		
	t-CO ₂ eq		g/m	1.98	1.98	2.51	2.82		
	Additional charge		g/m	20	20	20	20		
Fan Motor Output	Cooling	High	W	2087.5	2087.5	2087.5	2087.5		
	Heating	High	W	43	43	43	85		
Compressor Type				1P Rotary	1P Rotary	Twin Rotary	Twin Rotary		
Net Weight			kg	28.4	28.4	36.3	46		
Dimension			mm	717*483*230	717*483*230	770*545*288	870*655*320		

* This product contains Fluorinated greenhouse gases (R410A).
 ** S : Sleep / L : Low / M : Medium / H : High
 *** Specification, design and feature are subject to change without prior notice.

STANDARD PLUS (R32)

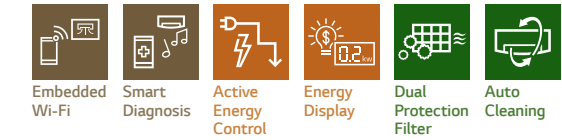

EUROVENT CERTIFIED PERFORMANCE
 LG participates in the ECP programme for EUROVENT AC program.
 Check ongoing validity of certification :
www.eurovent-certification.com



• Single Combination

UNIT		9K		12K		18K	
INDOOR		PC09SQ.NSJ		PC12SQ.NSJ		PC18SQ.NSK	
Capacity	Cooling	Min/Rated/Max	W	890/2500/3700	890/3500/4040	900/5000/5500	900/6600/7400
	Heating +7°C	Min/Rated/Max	W	890/3200/4100	890/4000/5100	900/5800/6400	
Power Input	Cooling	Rated	W	2600	3000	4200	
	Heating +7°C	Rated	W	656	1080	1562	
EER	Cooling	Rated	W/W	800	1050	1611	
	Heating +7°C	Rated	W/W	3.81	3.24	3.20	
S.E.E.R.			W/W	7.0	6.6	7.0	
P design C			kW	2.5	3.5	5.0	
COP			W/W	4.13	3.81	3.60	
S.C.O.P.			W/W	4.0	4.0	4.3	
P design H			kW	2.5	2.5	3.9	
Energy Label	Cooling (A++ to E Scale)			A++	A++	A++	
	Heating (A++ to E Scale)			A+	A+	A+	
Annual Energy Consumption	Cooling		kWh	125	186	250	
	Heating		kWh	875	875	1270	
Sound Pressure	Cooling	Sleep	dBA	19	19	31	
		Low	dBA	27	27	34	
		Medium	dBA	35	35	39	
	Heating	High	dBA	41	41	44	
		Low	dBA	27	27	34	
		Medium	dBA	35	35	39	
Sound Power	Cooling	High	dBA	41	41	44	
	Heating	High	dBA	59	59	60	
Air Flow Rate	Cooling	Sleep	m ³ /min	3.0	3.0	8.0	
		Low	m ³ /min	4.2	4.2	10.5	
		Medium	m ³ /min	7.5	7.5	13.0	
	Heating	High	m ³ /min	10.0	10.0	14.5	
		Max (Power)	m ³ /min	12.5	12.5	15.5	
		Low	m ³ /min	5.6	5.6	11.0	
Dehumidification Rate	Cooling	High	m ³ /min	7.2	7.2	13.5	
	Heating	High	m ³ /min	10.0	10.0	16.0	
Running Current	Cooling	Rated	A	3.3	4.7	6.9	
	Heating	Rated	A	6.0	6.0	9.0	
Starting Current	Cooling	Max	A	4.0	4.7	7.1	
	Heating	Max	A	7.0	7.0	9.5	
Power Supply	Cooling	Rated	A	3.3	4.7	6.9	
	Heating	Rated	A	4.0	4.7	7.1	
Circuit Breaker			Ø / V /Hz	1 / 220-240 / 50	1 / 220-240 / 50	1 / 220-240 / 50	
Power Supply Cable			A	15	15	20	
Power & Transmission Cable			N x mm ²	3*1.0	3*1.0	3 x 1.5	
Dimension			mm	4*1.0 (Including Earth)	4*1.0 (Including Earth)	4 x 1.0 (Including Earth)	
Net Weight			kg	8.7	8.7	11.9	
Fan Motor Output			W	30	30	30	
OUTDOOR		PC09SQ.UA3		PC12SQ.UA3		PC18SQ.UL2	
Operation Range	Cooling	Min-Max	°CDB	-10-48	-10-48	-15-48	-15-48
	Heating	Min-Max	°CDB	-10-24	-10-24	-10-24	-10-24
Sound Pressure	Cooling	High	dBA	48	48	53	53
	Heating	High	dBA	50	50	55	55
Sound Power	Cooling	High	dBA	65	65	65	65
	Heating	High	dBA	65	65	65	65
Air Flow Rate	Cooling	High	m ³ /min	27	27	35	35
	Heating	High	m ³ /min	27	27	35	35
Piping	Length (Odu/Idu)	Min	m	3	3	3	3
	Elevation (Odu/Idu)	Max	m	15	15	20	30
Piping Connection	Liquid	OD(Outside)	mm	6.35	6.35	6.35	6.35
		inch	(1/4)	(1/4)	(1/4)	(1/4)	
	Gas	OD(Outside)	mm	9.52	9.52	12.7	15.88
		inch	(3/8)	(3/8)	(1/2)	(3/8)	
	Drain	OD(Outside)	mm	21.5	21.5	21.5	21.5
		inch	OD(Outside)	mm	0.85	0.85	0.85
Refrigerant	Type			R32	R32	R32	R32
	Charge at 7.5m		g	700	700	1000	1000
	t-CO ₂ eq		g/m	0.47	0.47	0.68	0.68
	Additional charge		g/m	20	20	20	20
Fan Motor Output	Cooling	High	W	675	675	675	675
	Heating	High	W	43	43	43	43
Compressor Type				Twin Rotary	Twin Rotary	Twin Rotary	
Net Weight			kg	25.1	25.1	34.4	
Dimension			mm	717*483*230	717*483*230	770*545*288	

* This product contains Fluorinated greenhouse gases (R32).
 ** S : Sleep / L : Low / M : Medium / H : High
 *** Specification, design and feature are subject to change without prior notice.

STANDARD (R410A)

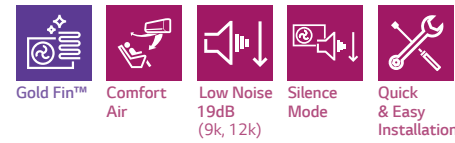

EUROVENT CERTIFIED PERFORMANCE
 LG participates in the ECP programme for EUROVENT AC program.
 Check ongoing validity of certification :
www.eurovent-certification.com

• Single Combination

UNIT		9K		12K		18K		24K	
INDOOR		P09EN.NSJ		P12EN.NSJ		P18EN.NSK		P24EN.NSK	
Capacity	Cooling	Min/Rated/Max	W	890/2500/3700	890/3500/4040	900/5000/5525	900/6500/7420	900/7500/8640	
	Heating +7°C	Min/Rated/Max	W	890/3200/4100	890/3800/5100	900/5800/6438			
Power Input	Heating -7°C	Rated	W	3000	3600	3800	4850		
	Cooling	Rated	W	670	1080	1587	2275		
EER	Heating +7°C	Rated	W/W	3.73	3.24	3.15	2.90		
	S.E.E.R.			6.5	6.4	6.5	6.2		
P design C			kW	2.5	3.5	5.0	6.6		
	COP		W/W	3.81	3.80	3.60	3.25		
S.C.O.P.				4.0	4.0	4.0	3.9		
	P design H		kW	2.4	2.5	3.9	5.0		
Energy Label	Cooling (A++ to E Scale)		A++	A++	A++	A++	A++		
	Heating (A++ to E Scale)		A+	A+	A	A	A		
Annual Energy Consumption	Cooling		kWh	134	191	269	372		
	Heating		kWh	840	875	1365	1794		
Sound Pressure	Cooling	Sleep	dBA	19	19	31	31		
		Low	dBA	27	27	34	34		
		Medium	dBA	35	35	39	42		
	Heating	High	dBA	41	41	44	47		
		Low	dBA	27	27	34	34		
		Medium	dBA	35	35	39	42		
Sound Power	Cooling	High	dBA	41	41	44	47		
	Heating	High	dBA	59	59	60	65		
Air Flow Rate	Cooling	Sleep	m ³ /min	3.0	3.0	8.0	8.0		
		Low	m ³ /min	4.2	4.2	10.5	10.5		
		Medium	m ³ /min	7.5	7.5	13.0	13.1		
	Heating	High	m ³ /min	10.0	10.0	14.5	16.1		
		Max (Power)	m ³ /min	11.5	12.5	15.5	20.0		
		Low	m ³ /min	5.6	5.6	11.0	11.0		
Dehumidification Rate	Medium	m ³ /min	7.2	7.2	13.5	15.0			
	High	m ³ /min	10.0	10.0	16.0	18.5			
Running Current	Cooling	Rated	A	3.0	4.7	6.9	10.1		
	Max	A	6.0	6.0	9.0	14.0			
Starting Current	Heating	Rated	A	3.7	4.5	7.1	10.4		
	Max	A	7.0	7.0	9.5	14.0			
Power Supply	Cooling	Rated	A	3.0	4.7	6.9	10.1		
	Heating	Rated	A	3.7	4.5	7.1	10.4		
Circuit Breaker			Ø / V /Hz	1 / 220-240 / 50	1 / 220-240 / 50	1 / 220-240 / 50	1 / 220-240 / 50		
			A	15	15	20	25		
Power Supply Cable			N x mm ²	3*1.0	3*1.0	3 x 1.5	3 x 2.5		
			N x mm ²	4*1.0 (Including Earth)	4*1.0 (Including Earth)	4 x 1.0 (Including Earth)	4 x 1.0 (Including Earth)		
Dimension			mm	837*308*189	837*308*189	998*345*210	998*345*210		
			kg	8.5	8.5	11.6	12.5		
Fan Motor Output			W	30	30	30	60		
OUTDOOR		P09EN.UA3		P12EN.UA3		P18EN.UL2		P24EN.UUE	
Operation Range	Cooling	Min-Max	°CDB	-10-48	-10-48	-15-48	-15-48		
	Heating	Min-Max	°CDB	-10-24	-10-24	-10-24	-10-24		
Sound Pressure	Cooling	High	dBA	49	49	53	56		
	Heating	High	dBA	50	50	55	57		
Sound Power	Cooling	High	dBA	65	65	65	70		
	Heating	High	dBA	65	65	65	70		
Air Flow Rate	Cooling	High	m ³ /min	27	27	35	50		
	Heating	High	m ³ /min	27	27	35	50		
Piping	Length (Odu/Idu)	Min	m	3	3	3	3		
	Elevation (Odu/Idu)	Max	m	15	15	20	30		
Piping Connection	Liquid	OD(Outside)	mm	6.35	6.35	6.35	6.35		
		inch	(1/4)	(1/4)	(1/4)	(1/4)			
	Gas	OD(Outside)	mm	9.52	9.52	12.7	15.88		
		inch	(3/8)	(3/8)	(1/2)	(3/8)			
	Drain	OD(Outside)	mm	21.5	21.5	21.5	21.5		
		inch	OD(Outside)	mm	0.85	0.85	0.85	0.85	
Refrigerant	Type			R410A	R410A	R410A	R410A		
	Charge at 7.5m		g	950	1200	1350	1000		
Additional charge	t-CO ₂ eq		g/m	1.98	1.98	2.51	2.82		
	GWP			20	20	20	20		
Fan Motor Output			W	2087.5	2087.5	2087.5	2087.5		
	Compressor Type			43	43	43	85		
Net Weight			kg	29	29	36.7	46		
	Dimension		mm	717*483*230	717*483*230	770*545*288	870*655*320		

* This product contains Fluorinated greenhouse gases (R410A).

** S : Sleep / L : Low / M : Medium / H : High

*** Specification, design and feature are subject to change without prior notice.

STANDARD (R32)



EUROVENT CERTIFIED PERFORMANCE
 LG participates in the ECP programme for EUROVENT AC program.
 Check ongoing validity of certification :
www.eurovent-certification.com

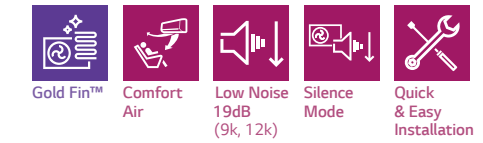

• Single Combination

UNIT		9K		12K		18K	
INDOOR		S09EQ.NSJ		S12EQ.NSJ		S18EQ.NSK	
Capacity	Cooling	Min/Rated/Max	W	890/2500/3700	890/3500/4040	900/5000/5500	900/6500/7420
	Heating +7°C	Min/Rated/Max	W	890/3300/4100	890/4000/5100	900/5800/6400	900/7500/8640
Power Input	Heating -7°C	Rated	W	2600	3000	4200	
	Cooling	Rated	W	656	1080	1562	
EER	Heating +7°C	Rated	W/W	3.81	3.24	3.20	
	S.E.E.R.			7.0	6.6	7.0	
P design C			kW	2.5	3.5	5.0	
	COP		W/W	4.13	3.81	3.60	
S.C.O.P.				4.0	4.0	4.3	
	P design H		kW	2.5	2.5	3.9	
Energy Label	Cooling (A++ to E Scale)		A++	A++	A++	A++	
	Heating (A++ to E Scale)		A+	A+	A+	A+	
Annual Energy Consumption	Cooling		kWh	125	186	250	
	Heating		kWh	875	875	1270	
Sound Pressure	Cooling	Sleep	dBA	19	19	31	
		Low	dBA	27	27	34	
		Medium	dBA	35	35	39	
	Heating	High	dBA	41	41	44	
		Low	dBA	27	27	34	
		Medium	dBA	35	35	39	
Sound Power	Cooling	High	dBA	41	41	44	
	Heating	High	dBA	59	59	60	
Air Flow Rate	Cooling	Sleep	m ³ /min	3.0	3.0	8.0	
		Low	m ³ /min	4.2	4.2	10.5	
		Medium	m ³ /min	7.5	7.5	13.0	
	Heating	High	m ³ /min	10.0	10.0	14.5	
		Max (Power)	m ³ /min	12.5	12.5	15.5	
		Low	m ³ /min	5.6	5.6	11.0	
Dehumidification Rate	Medium	m ³ /min	7.2	7.2	13.5		
	High	m ³ /min	10.0	10.0	16.0		
Running Current	Cooling	Rated	A	3.3	4.7	6.9	
	Max	A	6.0	6.0	9.0		
Starting Current	Heating	Rated	A	4.0	4.7	7.1	
	Max	A	7.0	7.0	9.5		
Power Supply	Cooling	Rated	A	3.3	4.7	6.9	
	Heating	Rated	A	4.0	4.7	7.1	
Circuit Breaker			Ø / V /Hz	1 / 220-240 / 50	1 / 220-240 / 50	1 / 220-240 / 50	
			A	15	15	20	
Power Supply Cable			N x mm ²	3*1.0	3*1.0	3 x 1.5	
			N x mm ²	4*1.0 (Including Earth)	4*1.0 (Including Earth)	4 x 1.0 (Including Earth)	
Dimension			mm	837*308*189	837*308*189	998*345*210	
			kg	8.7	8.7	11.9	
Fan Motor Output			W	30	30	30	
OUTDOOR		S09EQ.UA3		S12EQ.UA3		S18EQ.UL2	
Operation Range	Cooling	Min-Max	°CDB	-10-48	-10-48	-15-48	-15-48
	Heating	Min-Max	°CDB	-10-24	-10-24	-10-24	-10-24
Sound Pressure	Cooling	High	dBA	48	48	53	
	Heating	High	dBA	50	50	55	
Sound Power	Cooling	High	dBA	65	65	65	
	Heating	High	dBA	65	65	65	
Air Flow Rate	Cooling	High	m ³ /min	27	27	35	
	Heating	High	m ³ /min	27	27	35	
Piping	Length (Odu/Idu)	Min	m	3	3	3	
	Elevation (Odu/Idu)	Max	m	15	15	20	
Piping Connection	Liquid	OD(Outside)	mm	6.35	6.35	6.35	
		inch	(1/4)	(1/4)	(1/4)	(1/4)	
	Gas	OD(Outside)	mm	9.52	9.52	12.7	
		inch	(3/8)	(3/8)	(1/2)	(3/8)	
	Drain	OD(Outside)	mm	21.5	21.5	21.5	
		inch	OD(Outside)	mm	0.85	0.85	0.85
Refrigerant	Type			R32	R32	R32	
	Charge at 7.5m		g	700	700	1000	
Additional charge	t-CO ₂ eq		g/m	0.47	0.47	0.68	
	GWP			20	20	20	
Fan Motor Output			W	675	675	675	
	Compressor Type			43	43	43	
Net Weight			kg	25.1	25.1	34.4	
	Dimension		mm	717*483*230	717*483*230	770*545*288	

* This product contains Fluorinated greenhouse gases (R32).

** S : Sleep / L : Low / M : Medium / H : High

*** Specification, design and feature are subject to change without prior notice.

PRESTIGE

H09AP.NSM / H12AP.NSM

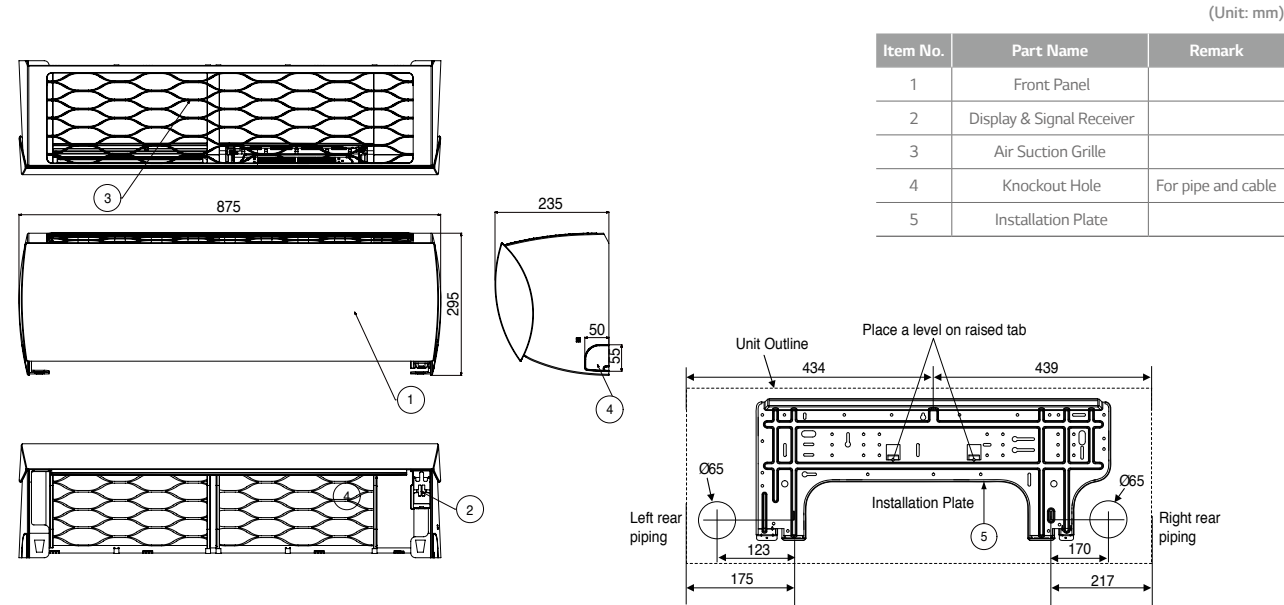

H09AP.U24 / H12AP.U24

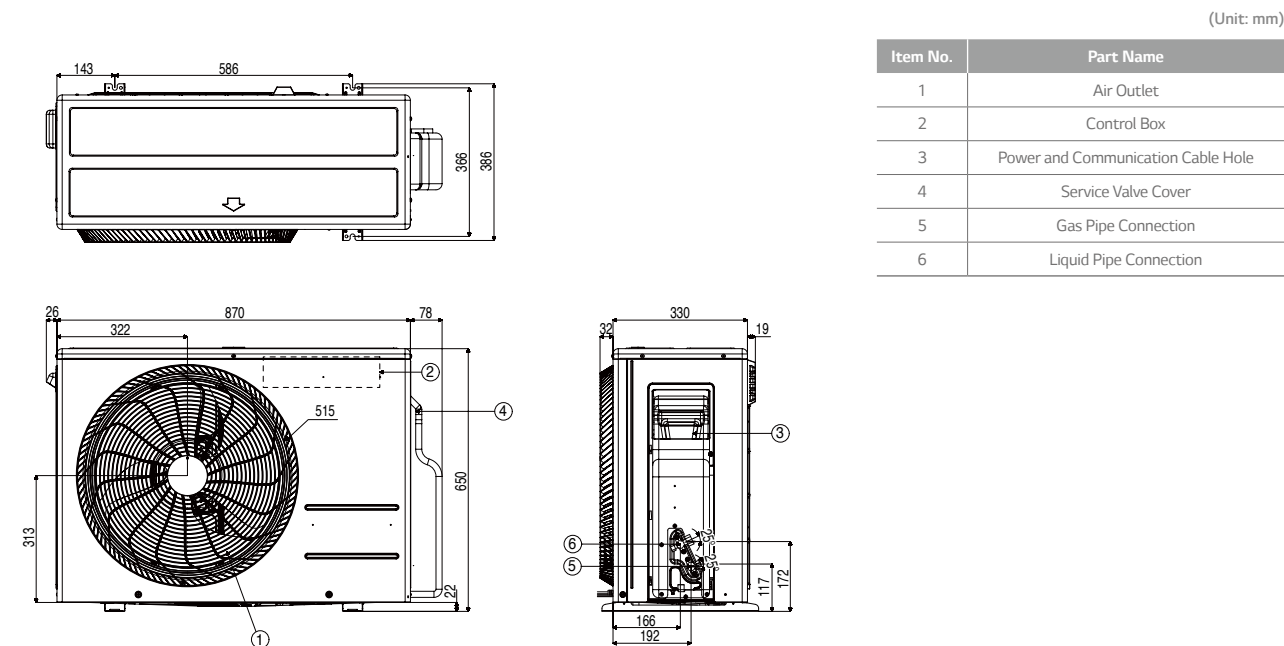

* This product contains Fluorinated greenhouse gases (R410A).

ARTCOOL STYLIST

G09WL.NS3 / G12WL.NS3

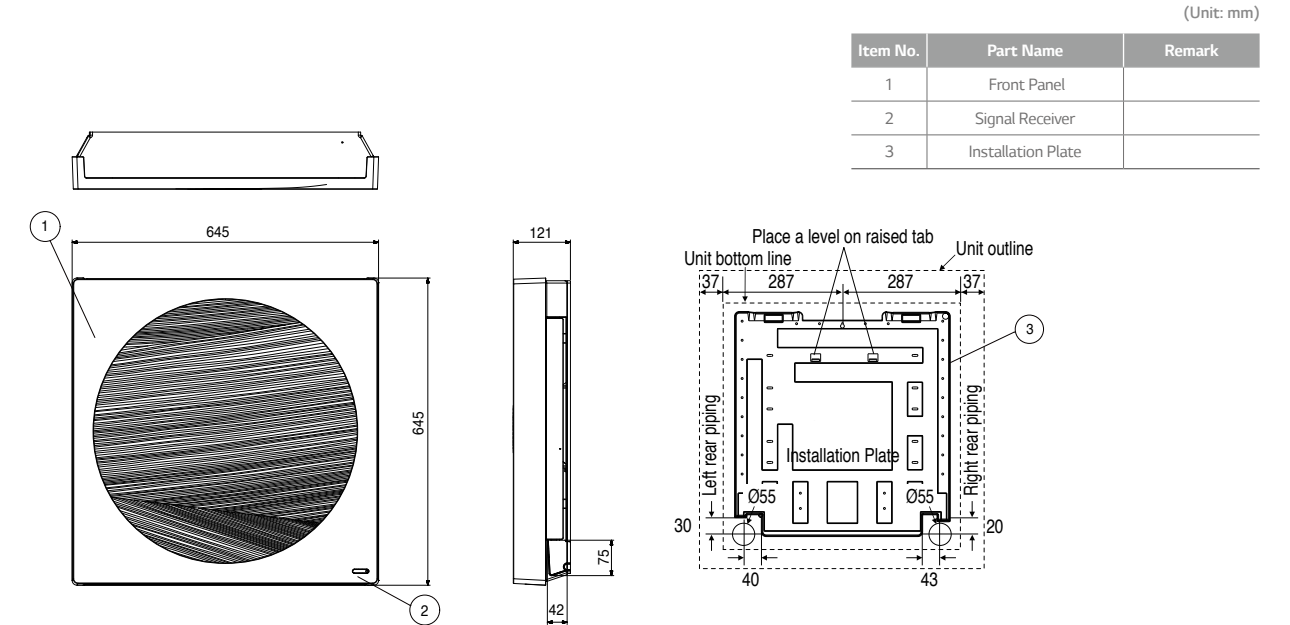

G09WL.UL2 / G12WL.UL2

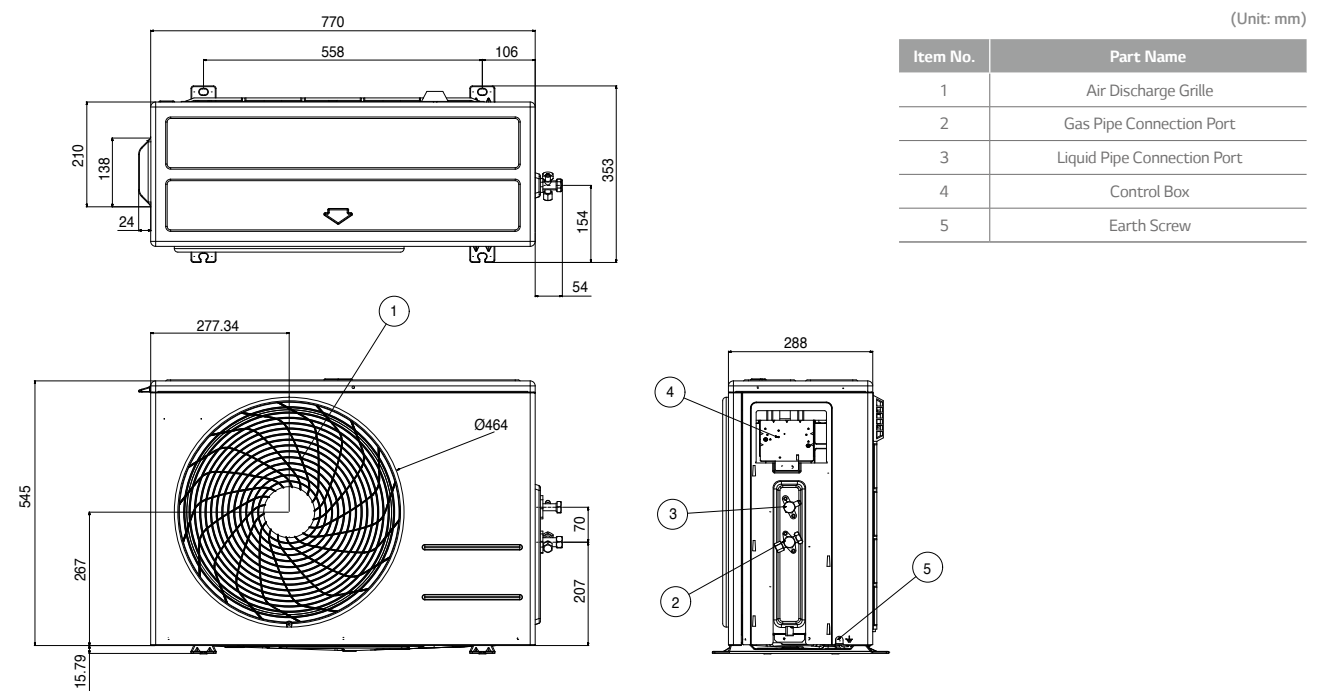

* This product contains Fluorinated greenhouse gases (R410A).

AC09BP.NSJ / AC12BP.NSJ / AM09BP.NSJ / AM12BP.NSJ

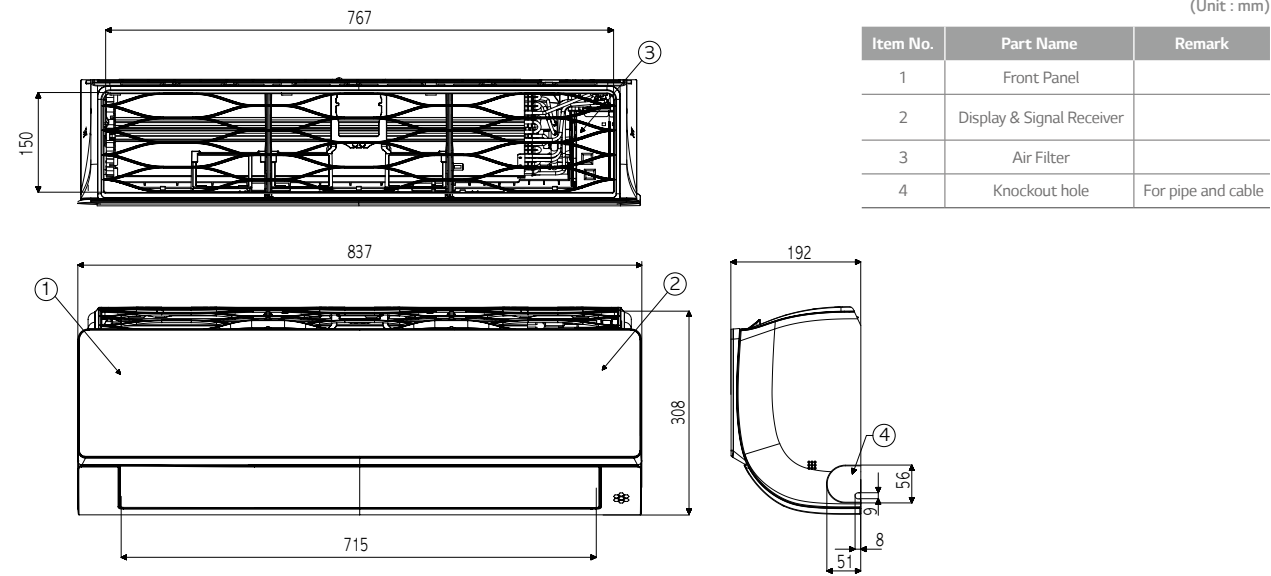

AC18BP.NSK / AM18BP.NSK

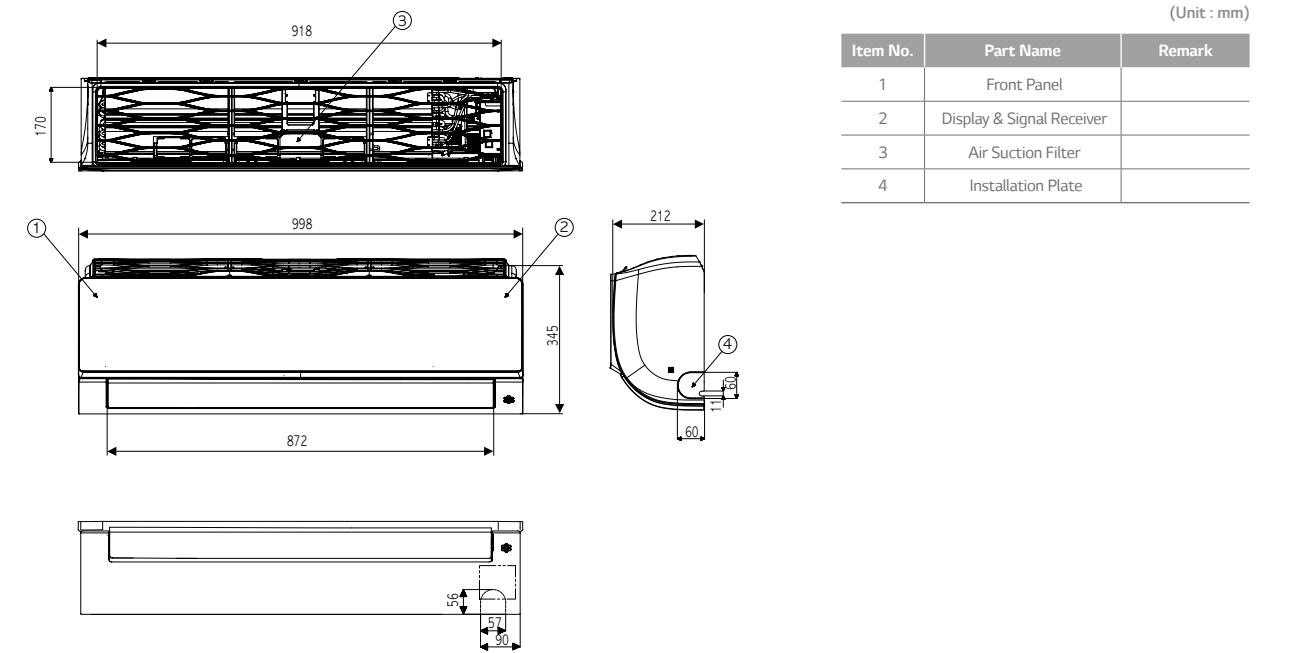

AC09BP.UA3 / AC12BP.UA3 / AM09BP.UA3 / AM12BP.UA3

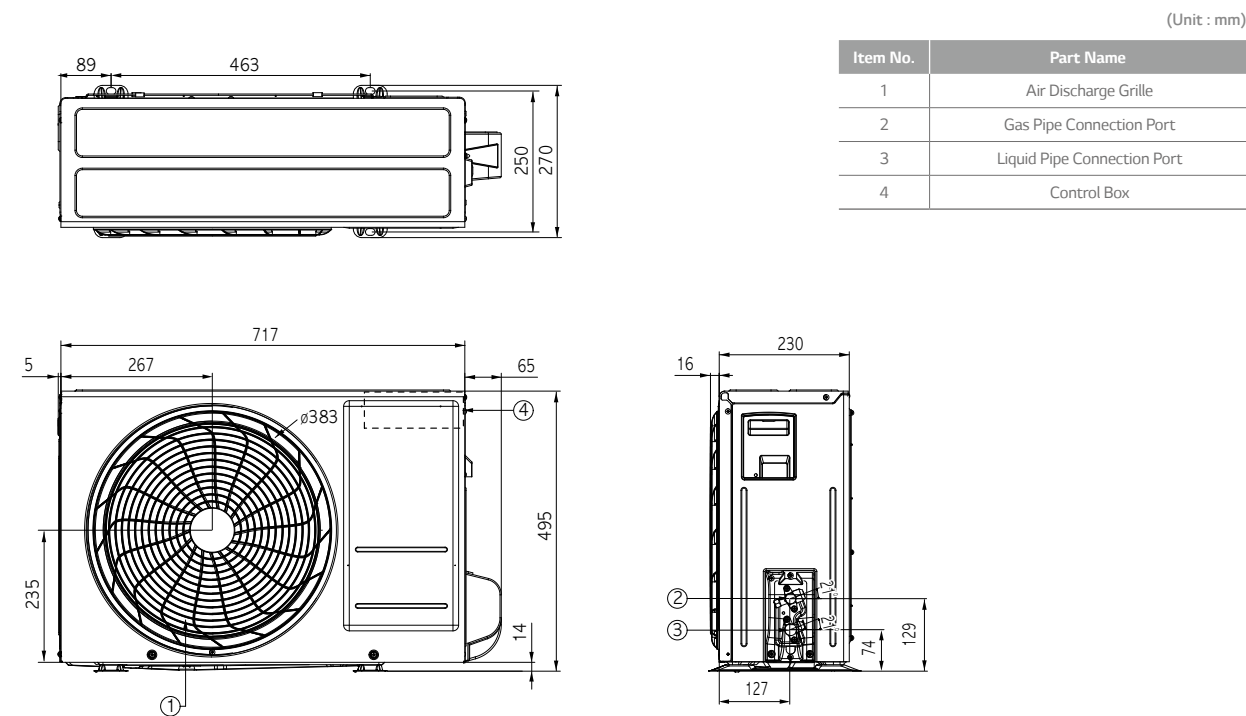

AC18BP.UL2 / AM18BP.UL2

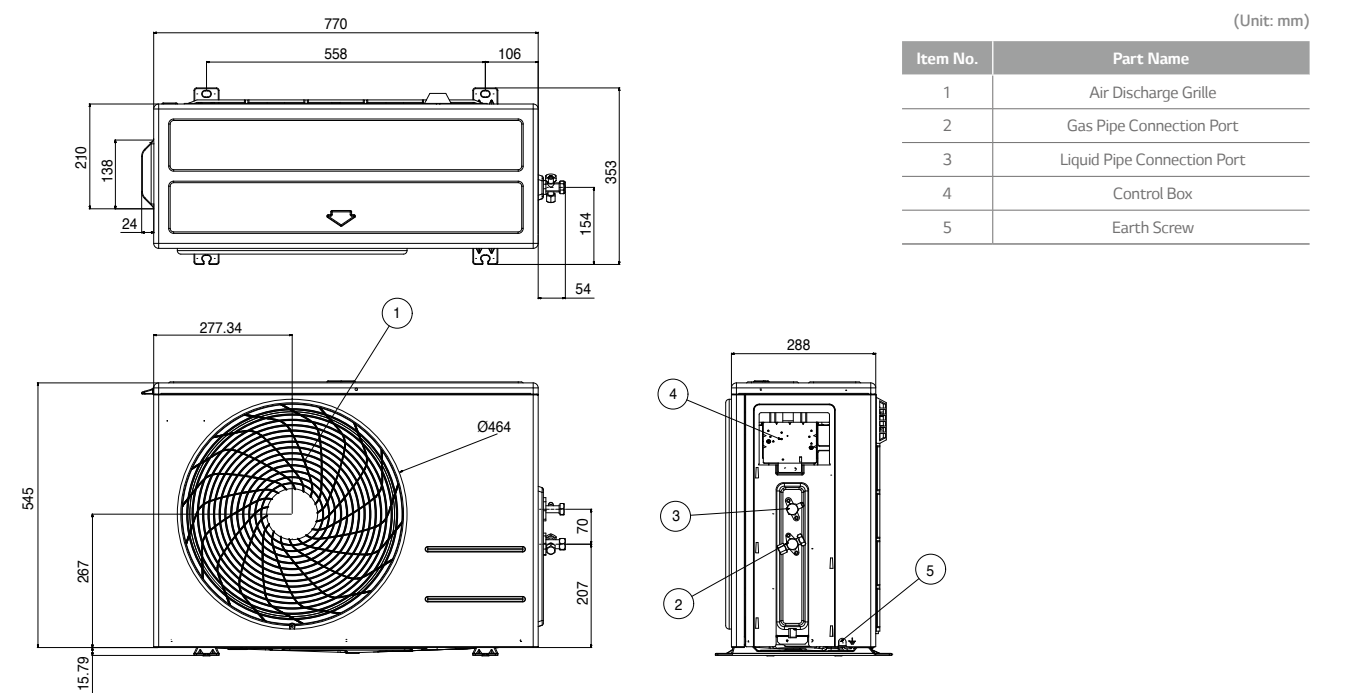

* This product contains Fluorinated greenhouse gases (R410A).

* This product contains Fluorinated greenhouse gases (R410A).

DELUXE

DC09RQ.NSJ / DC12RQ.NSJ / DM09RP.NSJ / DM12RP.NSJ

(Unit : mm)

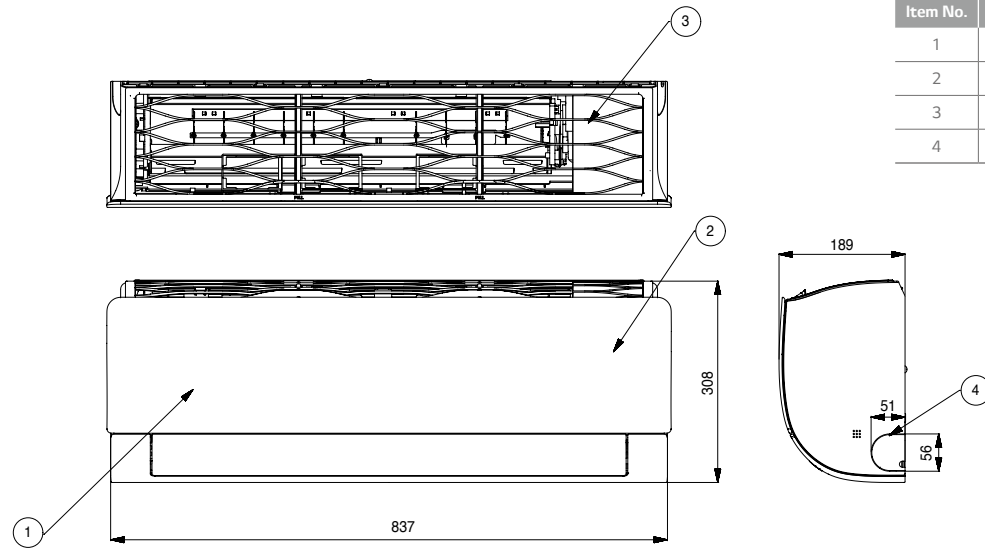

Item No.	Part Name	Remark
1	Front Panel	
2	Display & Signal Receiver	Hidden
3	Air Filter	
4	Knockout hole	For pipe and cable

DC18RQ.NSK / DM18RP.NSK / DM24RP.NSK

(Unit : mm)

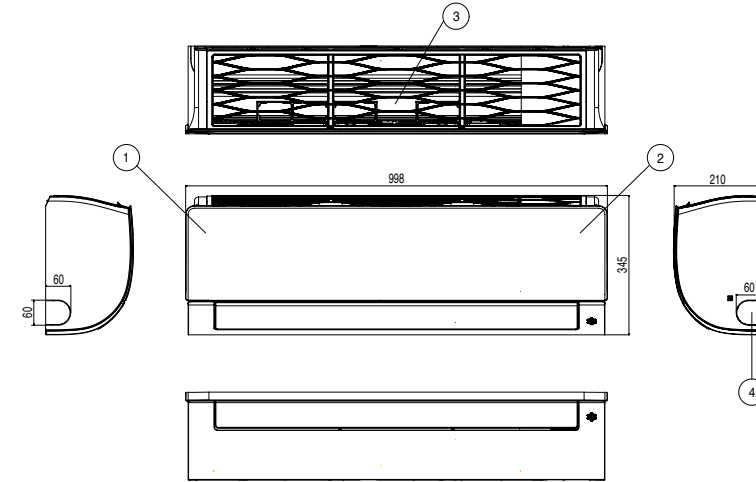

Item No.	Part Name	Remark
1	Front Panel	
2	Display & Signal Receiver	Hidden
3	Air Filter	
4	Knockout hole	For pipe and cable

DC09RQ.UL2 / DC12RQ.UL2 / DM09RP.UL2 / DM12RP.UL2

(Unit : mm)

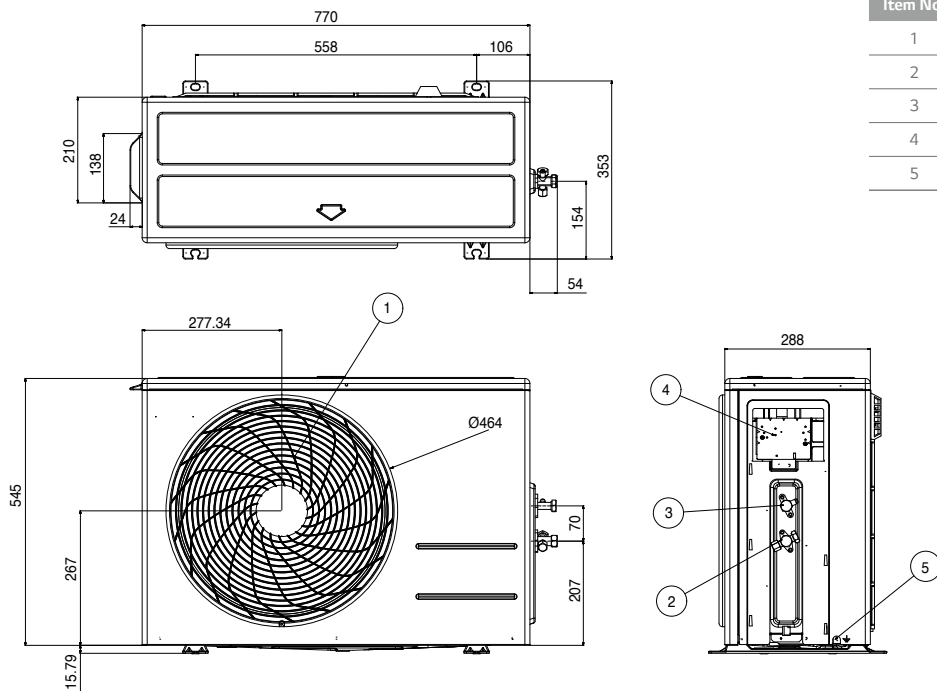

Item No.	Part Name
1	Air Discharge Grille
2	Gas Pipe Connection Port
3	Liquid Pipe Connection Port
4	Control Box
5	Earth Screw

DC18RQ.UL2 / DM18RP.UL2

DM24RP.UUE

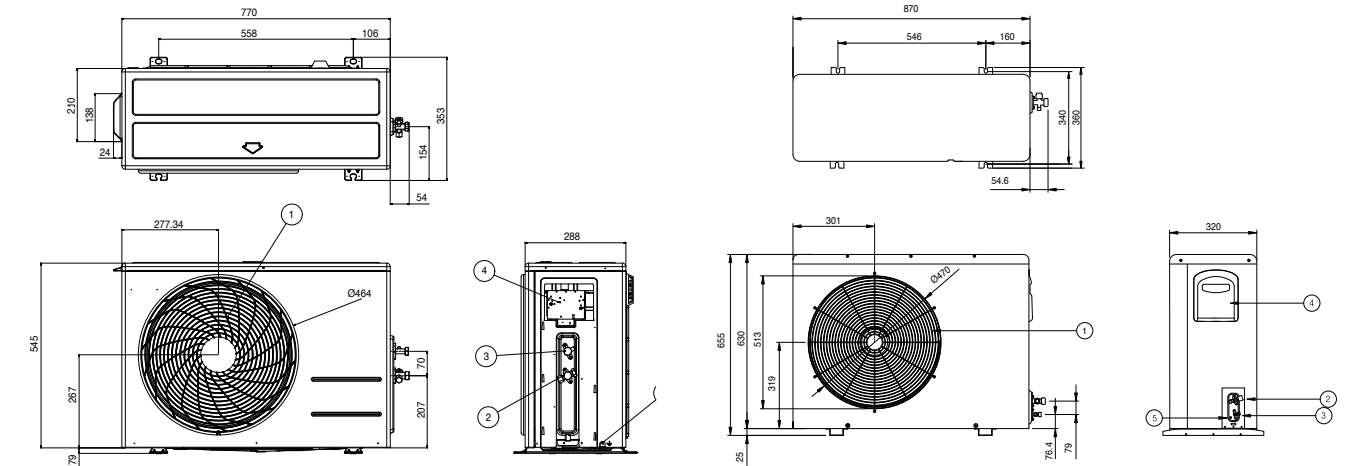

* This product contains Fluorinated greenhouse gases (R410A).

(Unit : mm)

Item No.	Part Name
1	Air Discharge Grille
2	Gas Pipe Connection Port
3	Liquid Pipe Connection Port
4	Control Box
5	Earth Screw

STANDARD PLUS

PC09SQ.NSJ / PC12SQ.NSJ / PM09SP.NSJ / PM12SP.NSJ

(Unit : mm)

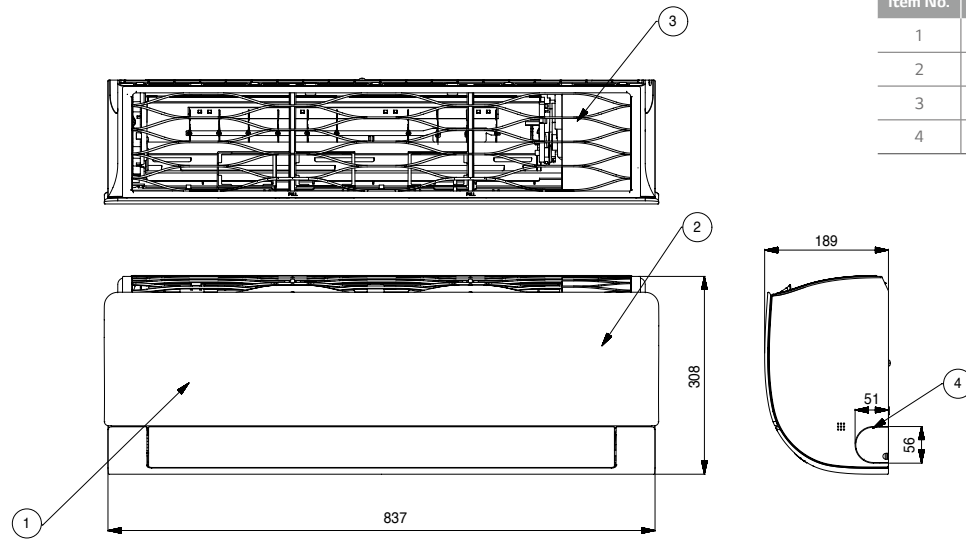

Item No.	Part Name	Remark
1	Front Panel	
2	Display & Signal Receiver	
3	Air Filter	
4	Knockout hole	For pipe and cable

PC18SQ.NSK / PM18SP.NSK / PM24SP.NSK

(Unit : mm)

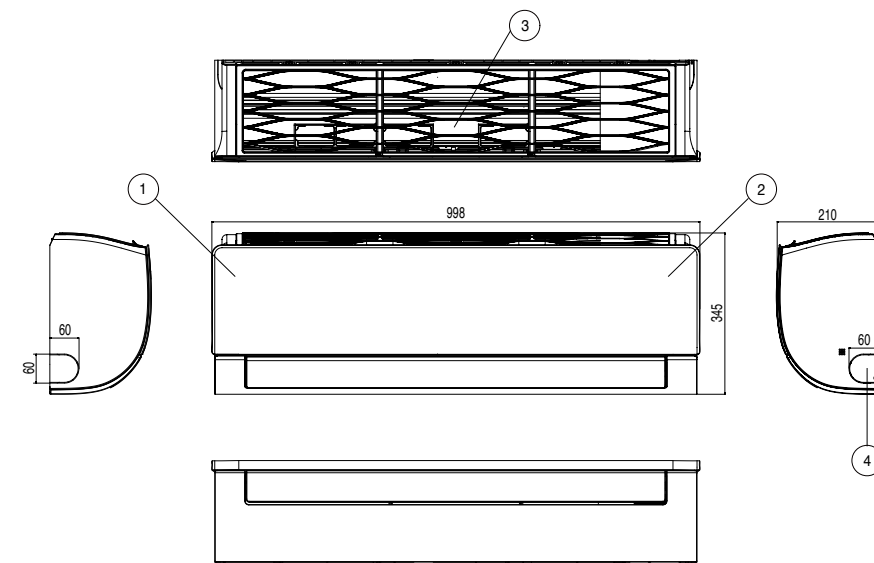

Item No.	Part Name	Remark
1	Front Panel	
2	Display & Signal Receiver	
3	Air Suction Filter	
4	Installation Plate	

PC09SQ.UA3 / PC12SQ.UA3 / PM09SP.UA3 / PM12SP.UA3

(Unit : mm)

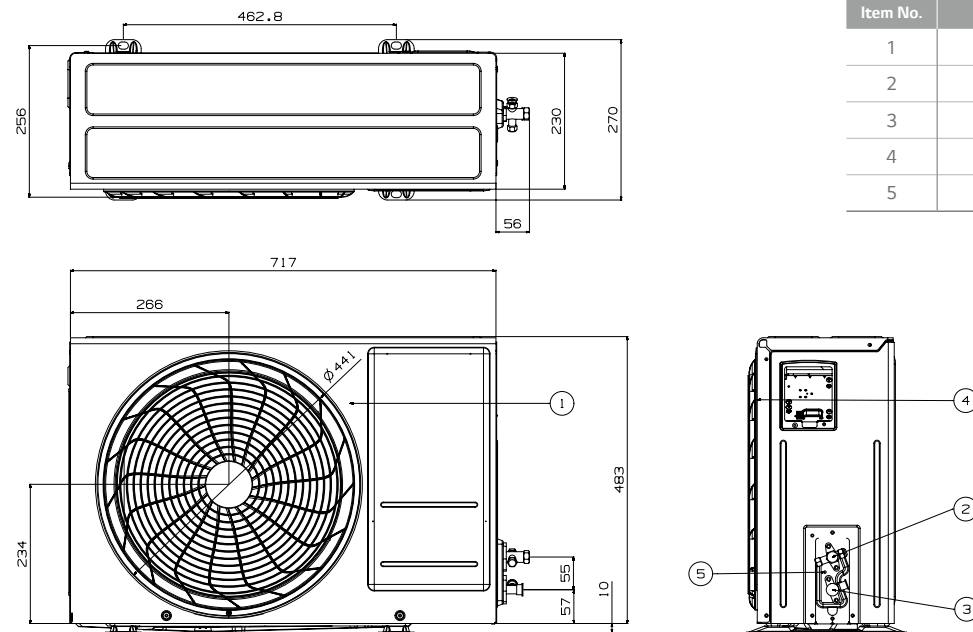

Item No.	Part Name
1	Air Discharge Grille
2	Gas Pipe Connection Port
3	Liquid Pipe Connection Port
4	Power & Transmission connection
5	Earth Screw

PC18SQ.UL2 / PM18SP.UL2

PM24SP.UUE

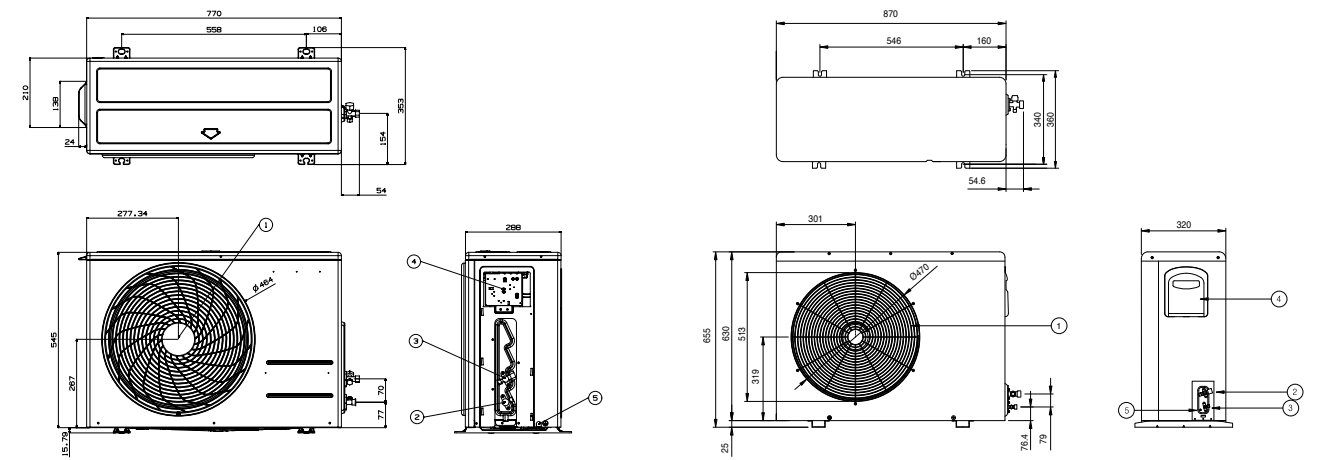

(Unit: mm)

Item No.	Part Name
1	Air Discharge Grille
2	Gas Pipe Connection Port
3	Liquid Pipe Connection Port
4	Control Box
5	Earth Screw

* This product contains Fluorinated greenhouse gases (R410A).

STANDARD

S09EQ.NSJ / S12EQ.NSJ / P09EN.NSJ / P12EN.NSJ

(Unit : mm)

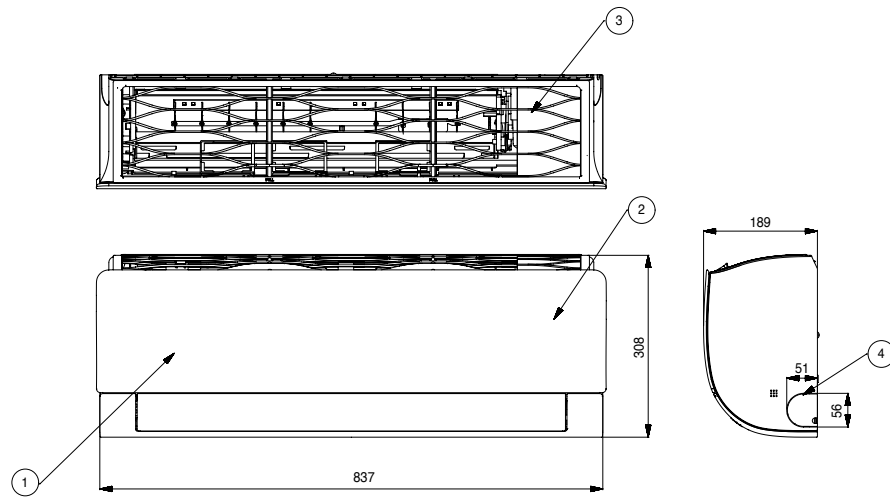

Item No.	Part Name	Remark
1	Front Panel	
2	Display & Signal Receiver	
3	Air Filter	
4	Knockout hole	For pipe and cable
5	Installation Plate	

S18EQ.NSK / P18EN.NSK / P24EN.NSK

(Unit : mm)

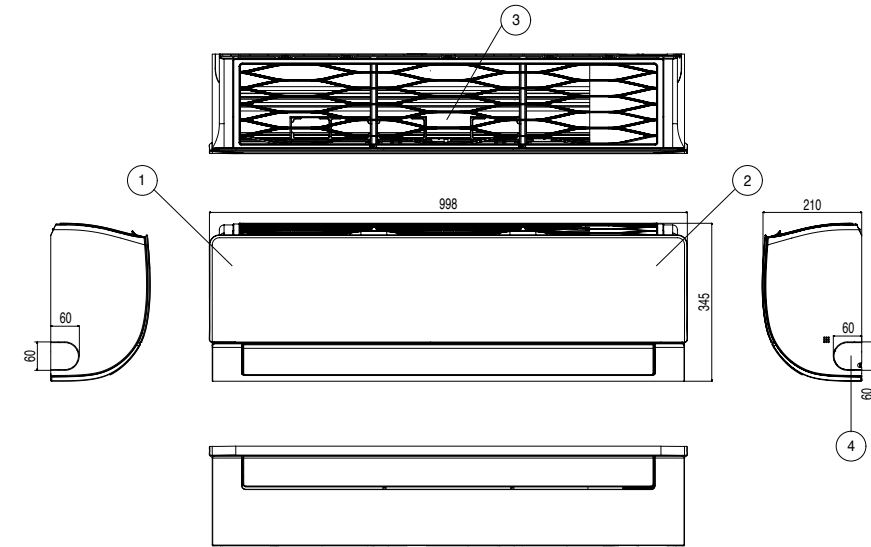

Item No.	Part Name	Remark
1	Front Panel	
2	Display & Signal Receiver	
3	Air Suction Filter	
4	Installation Plate	

S09EQ.UA3 / S12EQ.UA3 / P09EN.UA3 / P12EN.UA3

(Unit : mm)

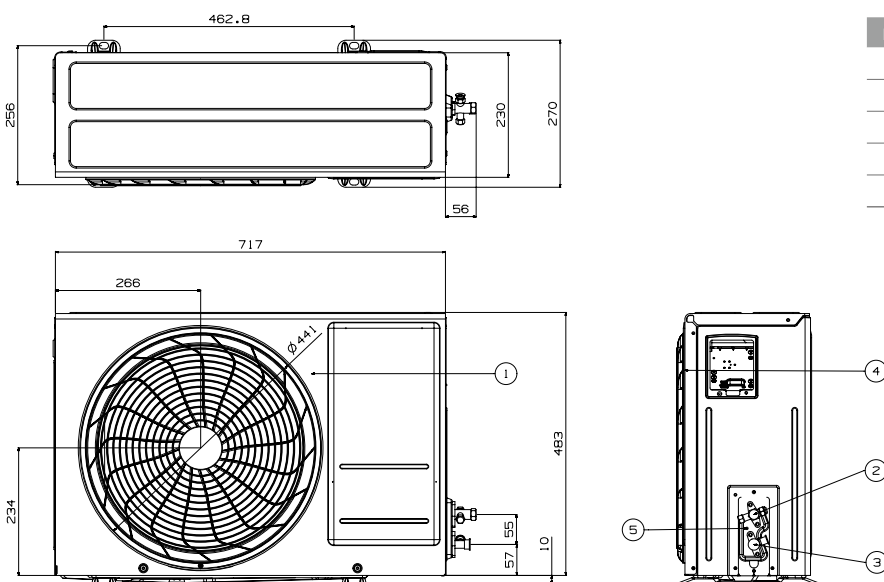

Item No.	Part Name
1	Air Discharge Grille
2	Gas Pipe Connection Port
3	Liquid Pipe Connection Port
4	Power & Transmission connection
5	Earth Screw

S18EQ.UL2 / P18EN.UL2

P24EN.UUE

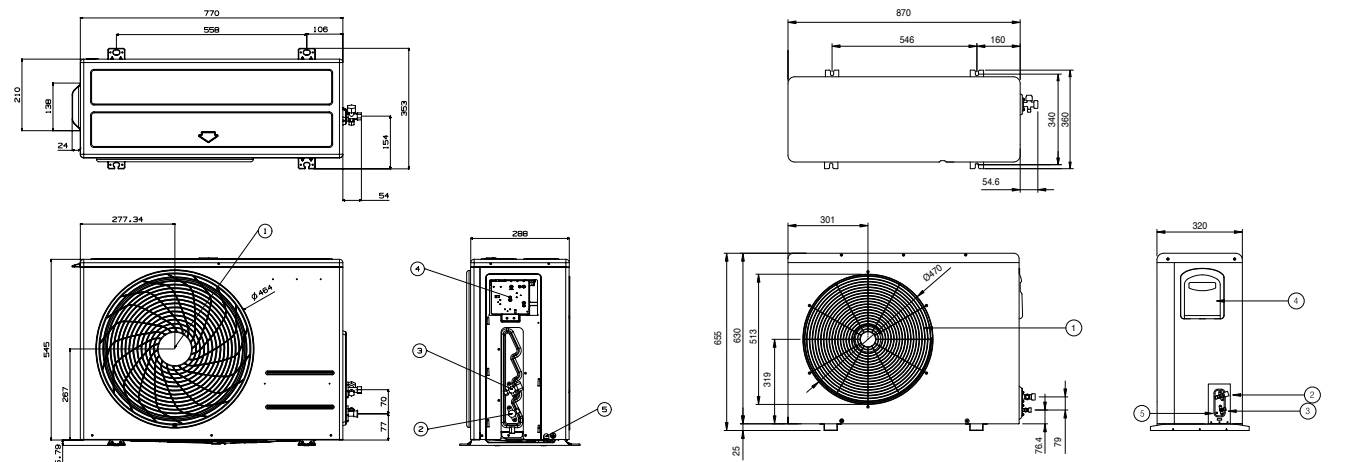

(Unit: mm)

Item No.	Part Name
1	Air Discharge Grille
2	Gas Pipe Connection Port
3	Liquid Pipe Connection Port
4	Control Box
5	Earth Screw

* This product contains Fluorinated greenhouse gases (R410A).

ACCESSORIES

		Prestige	ARTCOOL Stylist	ARTCOOL	Deluxe	Standard Plus	Standard
Wired Remote Controller	5k					Y	
	7k			Y	Y	Y	-
	9k	Y	Y	Y	Y	Y	-
	12k	Y	Y	Y	Y	Y	-
	15k					Y	
	18k			Y	Y	Y	-
PI 485	24k			Y	Y	Y	-
	5k					-	
	7k			-	Y*	-	-
	9k	-	-	-	Y*	-	-
	12k	-	-	-	Y*	-	-
	15k					-	
Dry Contact	18k			-	Y*	-	-
	24k			-	Y*	-	-
	5k					Y	
	7k			Y	Y	Y	-
	9k	Y	Y	Y	Y	Y	-
	12k	Y	Y	Y	Y	Y	-
Dry Contact	15k					Y	
	18k			Y	Y	Y	-
	24k			Y	Y	Y	-

* Y: Available
 * When connected to Multi 14k & 16k Outdoor units, this may not be supported.

Standard Wired Remote Controller



* Refer to each model PDB for applicable models.

MODEL NAME	PREMTB100 PREMTBB10	PREMTB001 PREMTBB01
Operation Mode	On/Off, Fan Speed Control, Temperature Setting	
Mode Change	Cooling / Heating / Auto / Dehumidification / Fan	
Auto Swing / Vane Control	-	-
Reservation	Simple / Sleep / On, Off / Weekly / Holiday	
Time Display	-	-
Electrical Failure Compensation	-	-
Child Lock	-	-
Operation Status LED	-	-
Indoor Temperature Display	-	-
Wireless Remote Controller Receiver	-	-
Size (W*H*D, mm)	120*120*16	120*121*16
Backlight	-	-

PI 485

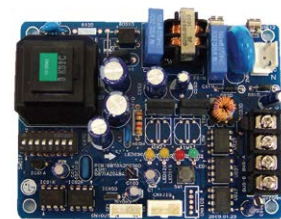

PMNFP14A1

Power : Single phase AC 220V 50/60Hz
 Max. no of the indoor units that can be connected: 64 UNITS
 Model applied : MULTI V, MULTI, Single A

* MULTI V II Series do not require any other PI 480 because PI 485 is inserted in their outdoor unit PCB.

Dry Contact



PDRYCB000 PDRYCB100 PDRYCB400

* Refer to each mode PDB for applicable models.

MODEL	PDRYCB000	PDRYCB100	PDRYCB400
Contact Point	1 Control Point	1 Control Point	2 Control Point
Power Input	AC 220V from outside power source	AC 24V from outside power source	DC 5V & 12V from indoor unit PCB
Voltage / Non Voltage Input			•
On / Off Control	•	•	•
Lock / Unlock			•
Fan Speed Setting			•
Thermo Off			•
Energy Saving			•
Temperature Setting			•
Error Monitoring	•	•	•
Operation Monitoring	•	•	•

Remote Controller



Prestige
 Artcool
 New Deluxe
 New Standard Plus
 Standard

Button	Display Screen	Description
[Power]	-	To turn On / Off the air conditioner.
[Temp Up/Down]	88°F	To adjust the desired room temperature in cooling, heating or auto changeover mode.
[COMFORT AIR]	-	To adjust the air flow to deflect wind.
[LIGHT OFF]	-	To set the brightness of the display on the indoor unit.
[MODE]	☀️	To select the cooling mode.
	☀️	To select the heating mode.
	💧	To select the dehumidification mode.
	🌀	To select the fan mode.
	🔄	To select the auto changeover / auto operation mode.
[FAN SPEED]	🌀	To adjust the fan speed.
[ENERGY CTRL.]	-	To bring the effect of the power saving.
[JET MODE]	Po	To change room temperature quickly.
[SWING]	🌀	To adjust the air flow direction vertically or horizontally.
[ROOM TEMP]	🏠	To display the room temperature.
°C ↔ °F [5sec]	°C/°F	To change unit between °C and °F.
[SET/CANCEL]	-	To set / cancel the functions and timer.
[Time Up/Down]	-	To adjust time.
[TIMER]	-	To turn on / off air conditioner automatically.
[CANCEL]	-	To cancel the timer settings.



ARTCOOL Stylist

Button	Display Screen	Description
[Lighting]	🏠	To adjust the brightness of the indoor lighting and to select a scene of the lighting.
[Timer]	🕒	To turn on/off air conditioner automatically at desired time.
[ROOM TEMP.]	🏠	To display the room temperature.
°C ↔ °F (5 s)	°C/°F	To change unit between °C and °F
[AUTO CLEAN]	🧼	To remove moisture generated inside the indoor unit.
[ENERGY SAVING]	🔋	To minimize power consumption.
[SILENT]	🔇	To reduce noise from outdoor unit.
[SET / CLEAR]	-	To set/cancel the function and timer.
[Time Up/Down]	-	To adjust time.
[TIME (3 s)]	-	To set the current time.
[RESET]	-	To initialize the remote control settings.

* NOTE : Some functions may not be supported, depending on the model.

MULTI SPLIT



MULTI SPLIT

R32 LINE-UP



INDOOR UNIT

○ Single Only ○● Compatible ● Multi Only

kBTu/h		05	07	09	12	15	18	24
kW		1.5	2.1	2.6	3.5	4.2	5.3	7.0
Wall Mounted Unit	ARTCOOL		● AM07BP	○● AM09BP	○● AM12BP		○● AM18BP	● AM24BP
	Deluxe		● DM07RP	○● DC09RQ	○● DC12RQ		○● DC18RQ	● DM24RP
	Standard Plus		● PM05SP	● PM07SP	○● PC09SQ	○● PC12SQ	● PM15SP	○● PC18SQ
		● MJ05PC	● MJ07PC	● MJ09PC	● MJ12PC	● MJ15PC	● MJ18PC	● MJ24PC
Ceiling Mounted Cassette	4 Way Cassette	● MT06R	● MT08R	● CT09R	● CT12R		● CT18R	● CT24R
	Mid / High Static Pressure						● CM18R	● CM24R
Ceiling Concealed Duct	Low Static Pressure			● CL09R	● CL12R		● CL18R	● CL24R

OUTDOOR UNIT

kBTu/h		14	16	18	21	24	27	30
kW		4.1	4.7	5.3	6.2	7.0	7.9	8.8
Multi	Multi Piping	● MU2R15 2-port	● MU2R15 2-port	● MU3R17 3-port	● MU3R21 3-port	● MU4R25 4-port	● MU4R27 4-port	● MU5R30 5-port

MULTI SPLIT

R410A LINE-UP

INDOOR UNIT

kBTu/h		5	7	9	12	15	18	24
kW		1.5	2.1	2.6	3.5	4.2	5.3	7.0
Wall Mounted Unit	ARTCOOL Gallery			● MA09AH1	● MA12AH1			
	ARTCOOL		● AM07BP	● AM09BP	● AM12BP		● AM18BP	● AM24BP
	Deluxe		● DM07RP	● DM09RP	● DM12RP		● DM18RP	● DM24RP
Ceiling Mounted Cassette	Standard Plus	● PM05SP	● PM07SP	● PM09SP	● PM12SP	● PM15SP	● PM18SP	● PM24SP
	1 Way Cassette			● MT09AH	● MT12AH			
	4 Way Cassette	● MT06AH	● MT08AH	● CT09	● CT12		● CT18	● CT24
Ceiling Concealed Duct	Mid / High Static Pressure						● CM18	● CM24
	Low Static Pressure			● CB09L	● CB12L		● CB18L	● CB24L
Ceiling & Floor Convertible			● CV09	● CV12				
Console			● CQ09	● CQ12			● CQ18	

OUTDOOR UNIT

kBTu/h		14	16	18	21	24	27	30	40	46	48	57
kW		4.1	4.7	5.3	6.2	7.0	7.9	8.8	11.7	13.5	14.1	16.7
Multi	Multi Piping	● MU2M15 2-port	● MU2M15 2-port	● MU3M17 3-port	● MU3M21 3-port	● MU4M25 4-port	● MU4M27 4-port	● MU5M30 5-port	● MU5M40 5-port			
	Distribution Box								● FM40AH 7-IDU	● FM41AH 7-IDU	● FM48AH 8-IDU	● FM56AH 9-IDU

FEATURE OVERVIEW

Category		R32 MULTI PIPING						
kBTu/h		14	16	18	21	24	27	30
kW		4.1	4.7	5.3	6.2	7.0	7.9	8.8
Energy Efficiency	BLDC Comp. & Fan Motor	•	•	•	•	•	•	•
	Eurovent Certification	•	•	•	•	•	•	•
	Wide Louver Plus Fin	•	•	•	•	•	•	•
	Optimised Heat Exchanger Path	•	•	•	•	•	•	•
	Smart Load Control			•	•	•	•	•
	Peak Current Control	•	•	•	•	•	•	•
	Standby Mode	•	•	•	•	•	•	•
	Mode Lock	•	•	•	•	•	•	•
Durability	Twin Rotary Compressor	•	•	•	•	•	•	•
	Smart Sensor Pressure Control			•	•	•	•	•
	Ocean Black Fin Heat Exchanger	•	•	•	•	•	•	•
Comfort & Convenience	Fast Cooling & Heating			•	•	•	•	•
	Night Silent Operation	•	•	•	•	•	•	•
	Wiring Error Check	•	•	•	•	•	•	•
	Monitoring PCB	•	•	•	•			
	LG MV	•	•	•	•	•	•	•
	Forced Cooling Operation	•	•	•	•	•	•	•

R410A MULTI PIPING								R410A DB BOX TYPE			
14	16	18	21	24	27	30	40	40	46	48	57
4.1	4.7	5.3	6.2	7.0	7.9	8.8	11.7	11.7	13.5	14.1	16.7
•	•	•	•	•	•	•	•	•	•	•	•
•	•	•	•	•	•	•	•	•			
•	•	•	•	•	•	•	•	•	•	•	•
•	•	•	•	•	•	•	•	•	•	•	•
		•	•	•	•	•	•	•			
•	•	•	•	•	•	•	•	•	•	•	•
•	•	•	•	•	•	•	•				
•	•	•	•	•	•	•	•	•	•	•	•
•	•	•	•	•	•	•	•	•	•	•	•
•	•	•	•	•	•	•	•	•	•	•	•
•	•	•	•	•	•	•	•	•	•	•	•

KEY FEATURES

PERFECT SOLUTION FOR MULTIPLE ROOMS



Energy Efficiency | Extreme Durability | Comfort and Convenience

LG Multi split system provides powerful, efficient cooling and heating with two, three, four, or up to nine indoor units operating off a single outdoor unit. LG's advanced inverter technology brings powerful performance while consuming less energy and it uses less space than installing individual single split systems. A variety of sleek and elegant indoor units to complement any décor are available in a full range of capacities for all room sizes. Installation is easy and it offers various convenient functions for easy maintenance.



ENERGY EFFICIENCY

ENERGY EFFICIENCY

The advanced technologies of LG achieve the lowest energy consumption, especially SEER value regarding ErP regulation.

World Class High Efficiency
SEER **8.5**

SEER / SCOP class (ErP regulation)		4.1	4.7	5.3	6.2	7.0	7.9	8.8
kW	SEER	8.5	7.8	8.5	8.5	8.2	8.0	8.2
	SCOP	A+++	A++	A+++	A+++	A++	A++	A++
kW	SEER	4.2	4.2	4.2	4.2	4.2	4.2	4.2
	SCOP	A+	A+	A+	A+	A+	A+	A+

- BLDC Inverter Twin Rotary Compressor
- Enhanced Heat Exchanger
- Smart Load Control
- Peak current control

Enhanced Heat exchange by Wide Louver Plus Fin

Wide Louver Plus fin technology increases 11% of full load heating performance and 6% of COP compared to conventional fin. It can slow down frosting of heat exchanger and postpone the start of defrosting operation.

• Heating Operation at Defrost Condition

It can slow down frosting of heat exchanger and postpone the start of defrosting operation

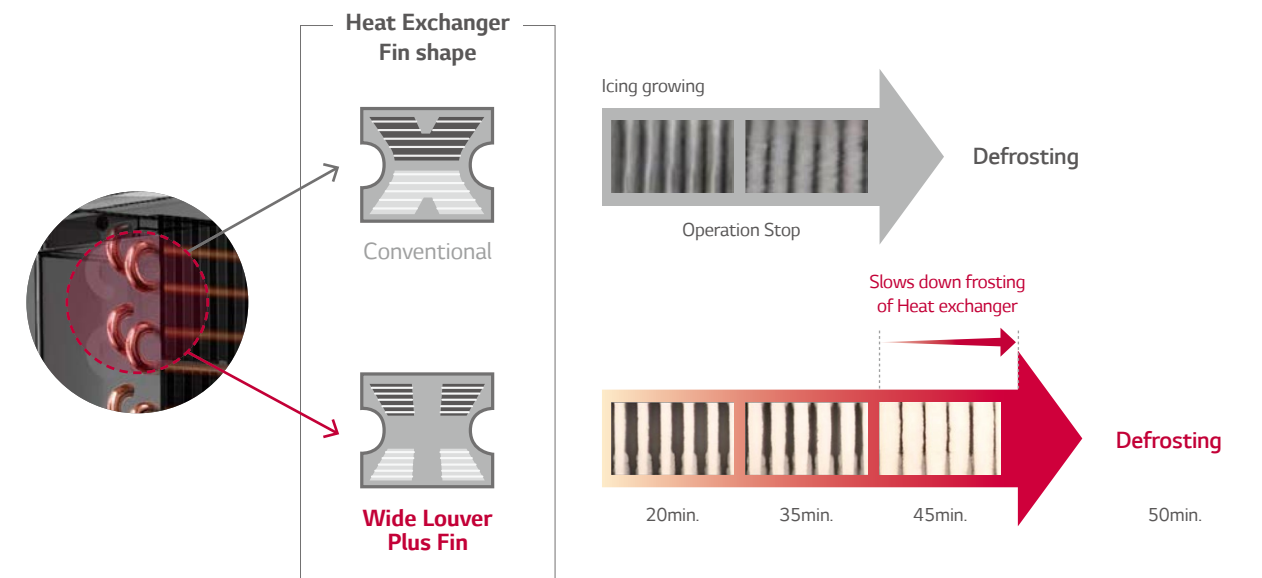

Powerful BLDC (Brushless Direct Current Motor) Compressor

LG air conditioners are equipped with a BLDC Inverter Twin Rotary Compressor that uses a neodymium magnetic core. The compressor has high efficiency and superior reliability, because it is excellent in controlling the operating speed depending on the load. The compressor has improved efficiency compared to standard AC inverter products and optimized for changes of outdoor load. Especially it is optimized for seasonal efficiency.

• Operation Range

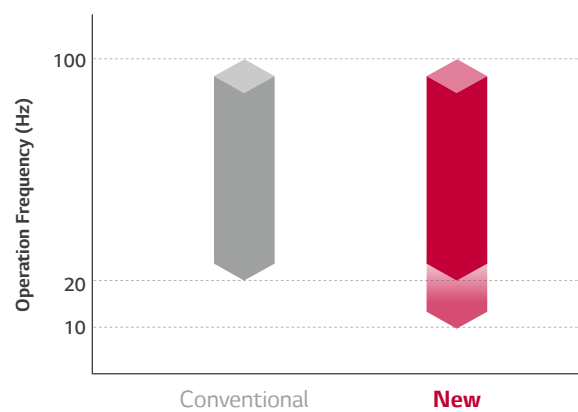

• Motor Efficiency

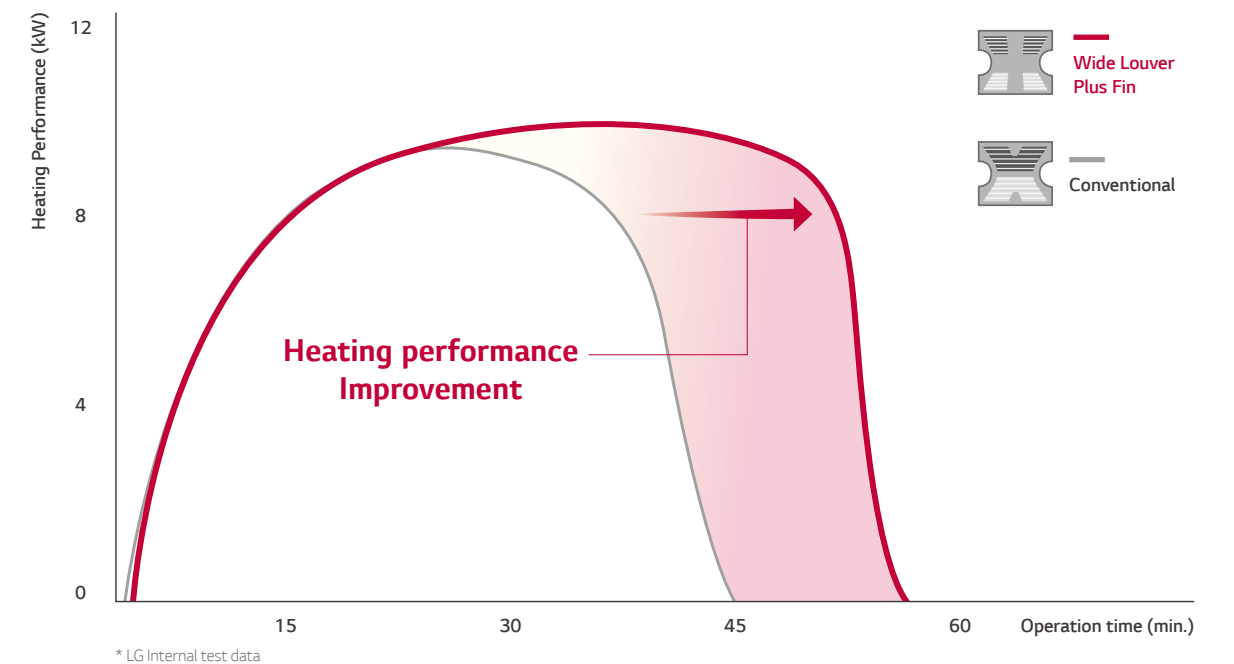
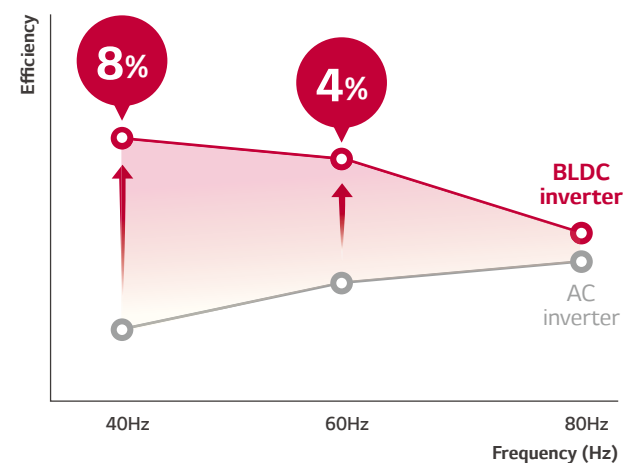

ENERGY EFFICIENCY

Smart Load Control

To save operation energy, it automatically controls the refrigerant temperature according to outside temperature.

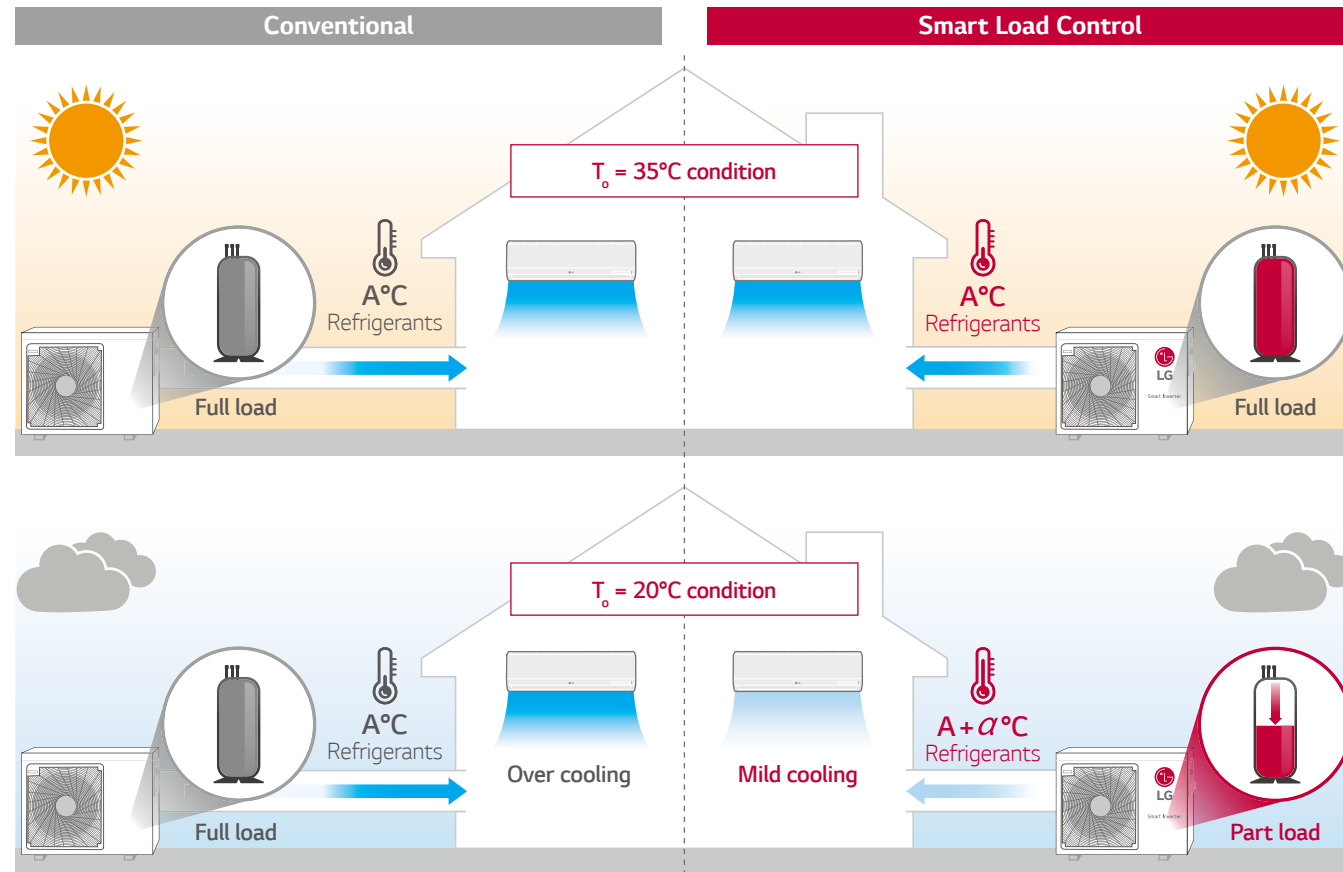

* T_o : Outdoor temperature
* A is the indoor unit coil temperature

• How to set dip switch

To operate smart load control, dip switch setting is needed. It can save energy on real time operation.

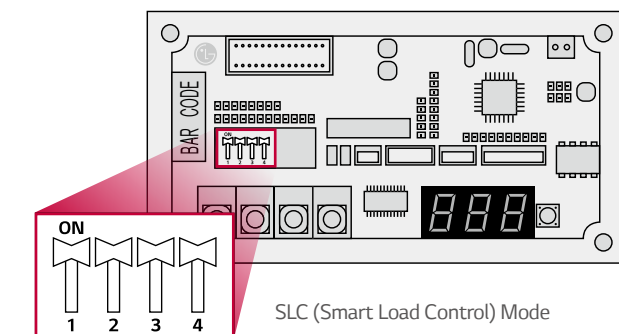

• Real Time Energy Saving

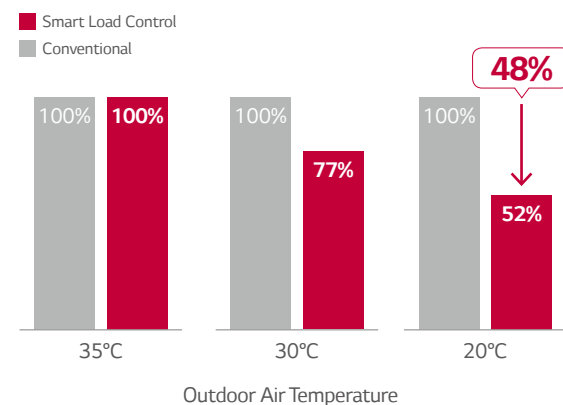

* Applied models : MU3R19 UE0 / MU3R21 UE0 / MU4R25 U40 / MU4R27 U40 / MU5R30 U40 / MU3M19 UE4 / MU3M21 UE4 / MU4M25 U44 / MU5M30 U44 / MU5M40 U02

Peak Current Control

The peak current control function keeps the air conditioner from running at the maximum level while maintaining current system setting, in order to reduce energy consumption. This function can help to cut energy costs during the peak periods of energy use when the energy fee is much higher.

• How to set dip switch

STEP 1 Max power consumption : 1.9 kW

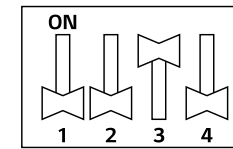

STEP 2 Max power consumption : 1.7 kW

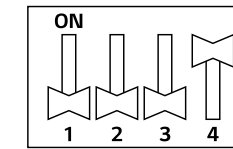

* Full Load consumption : 2.5kW
* 7.0kW model
* LG Internal test result

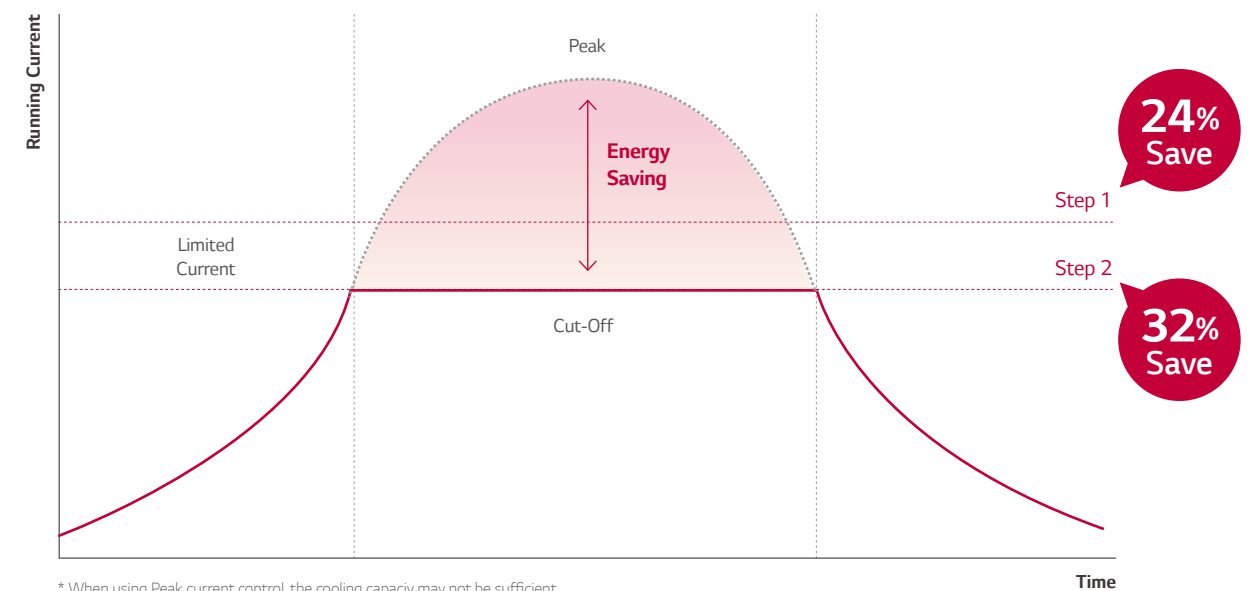

* When using Peak current control, the cooling capacity may not be sufficient.
* 7.0kW model
* LG Internal test result

EXTREME DURABILITY

EXTREME DURABILITY

Product safety is emphasized by offering a 10-year warranty on the compressor to reassure customers about product durability.



INVERTER COMPRESSOR

10

YEAR

WARRANTY

Product Safety & Durability Reassured

- Improved BLDC Inverter Twin Rotary compressor
- Smart Sensor
- Black Fin Heat Exchanger

Pressure Control Technology by Smart Sensor

Quicker and more reliable operation is possible from pressure control technology.

• Field Failure Rate of Outdoor unit

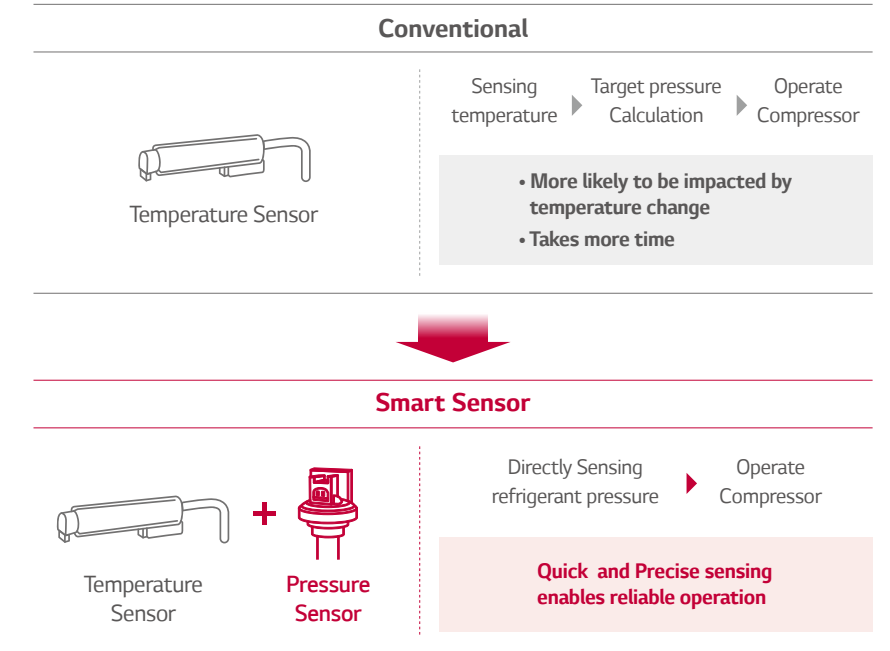
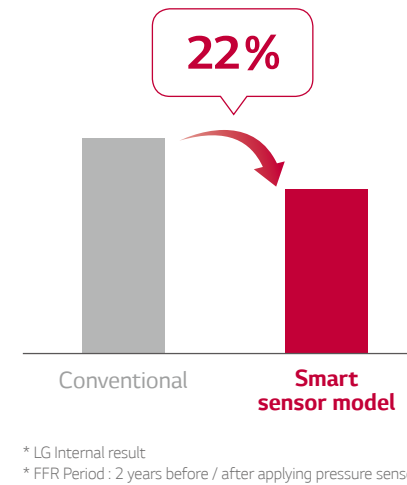

Improved BLDC Inverter Twin Rotary Compressor

Parts of BLDC Inverter Twin Rotary Compressor have been improved to allow for a longer life span.

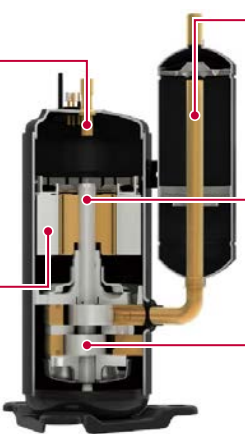

Flow Optimization
Reduced oil inflow by increasing the length of oil discharge pipe, which remains enough oil inside the compressor to prevent compressor abrasion.

Suction Optimization
Reduced suction loss and improving oil collection through the optimization of suction path.

Surface Coating
Shaft coating and polishing has been improved.

Concentrated Winding Motor
Oil path area is improved by over 50% by increasing the extra stator cavity. Due to this, caloric value of motor is reduced, improving the cooling function of stator coil.

Twin Rotary Rotor
- Upper and lower part rotor offset imbalance in shaft rotor rotation. Max Torque has been decreased by 45% compared to single rotor.
- Vibration and noise is also reduced.

Twin Rotary Inverter Compressor

Black Fin Heat Exchanger

The black coating with enhanced epoxy resin is applied for strong protection from various corrosive external conditions such as salt contamination and air pollution including fumes from factories. Moreover, the hydrophilic film keeps water from accumulating on the heat exchanger's fin, minimizing moisture buildup and eventually making it even more corrosion resistant.

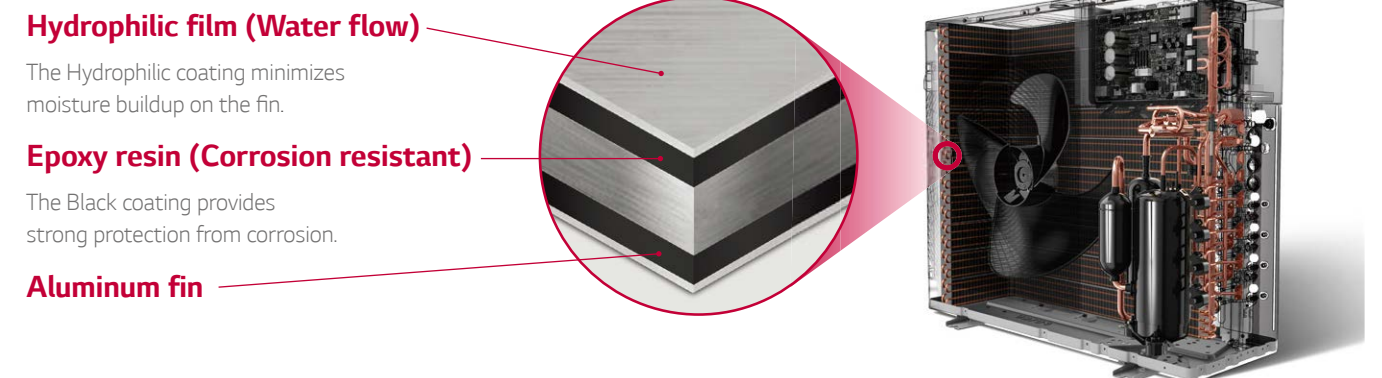

Hydrophilic film (Water flow)
The Hydrophilic coating minimizes moisture buildup on the fin.

Epoxy resin (Corrosion resistant)
The Black coating provides strong protection from corrosion.

Aluminum fin

COMFORT AND CONVENIENCE



Night Silent Operation

Night silent operation can reduce noise levels at night time by simply setting the dip switch on the PCB of the outdoor unit.

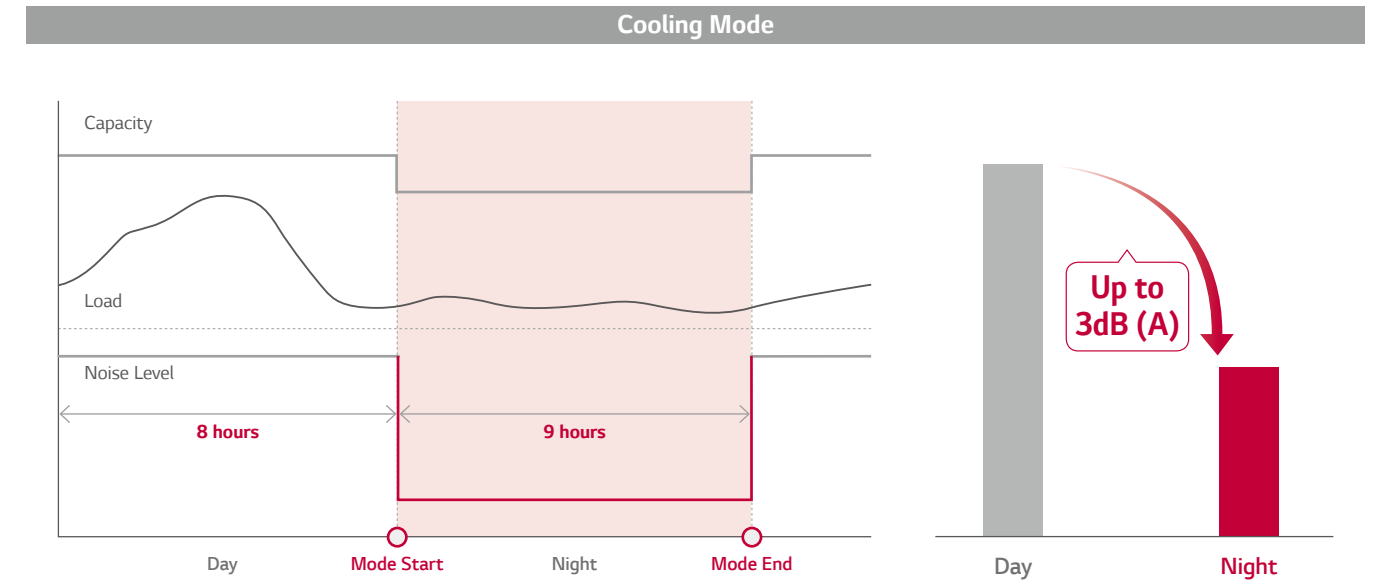

Fast Cooling & Heating

Pressure control takes less time to reach the desired temperature up to 30% in cooling and 44% in heating with high level of accuracy and stability.

• Cooling

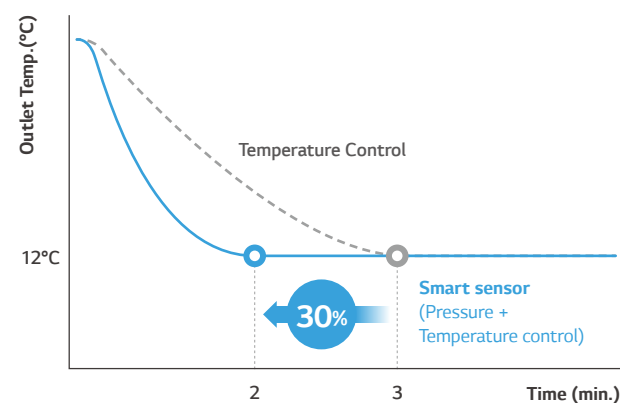

• Heating

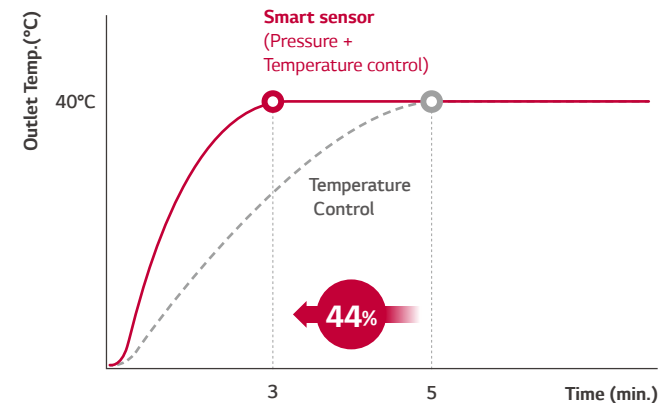

* LG Internal test result

Wiring Error Check

Installers can check whether the transmission cable has been connected correctly by using the wiring error check function. The wiring error check function can reduce the time taken to check for transmission cable errors.

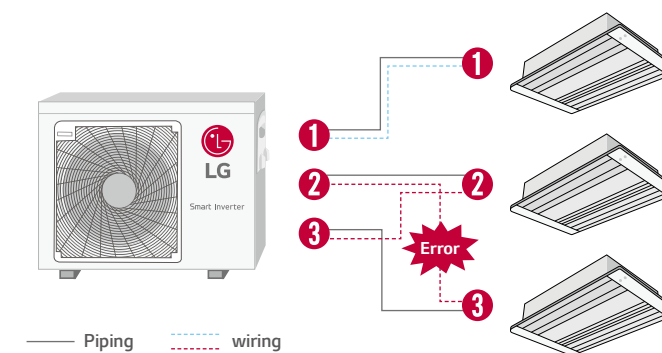

• LED Result

- If the wiring is correct, the Green LED will light up.
- If the wiring is wrong, display as below
 - Red LED : Piping Number
 - Green LED : Wiring Number (Room)

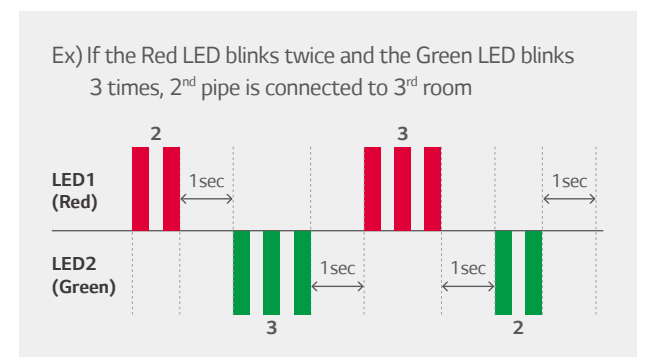

COMFORT AND CONVENIENCE

Monitoring PCB

If there is any problem, without disassembly of chassis, engineers can quickly check air conditioner's error code through 7-segment error indicator

Conventional

Many tools are needed for checking cycle data.

Monitoring PCB

Easy & Quick cycle data Check by Monitoring PCB

Outdoor unit

• UL4, UE4 chassis

STEP 1
Opening the control cover

3 SCREW

STEP 2
Simply Checking the data on PCB

7-segment error indicator

STEP 3
Displayed Error code sample

0.5 sec off ↑ ↓ 0.5 sec off

• Displayed Error code

Error Code	Contents	Case of Error	Outdoor Status
21	DC Link Peak (IPM Fault)	Over Rated Current	Off
22	CT 2 (Max CT)	Input Over Current	Off
23	DC Link Low Volt.	DC Link Volt is below 140V dc	Off
	DC Link High Volt.	DC Link Volt is above 420V dc	
25	Low Voltage / Over Voltage	Abnomal AC volt Input	Off
26	DC Compressor Position Error	Compressor Starting Fall Error	Off
27	PSC / PFC Fault Error	Over inverter PCB input Current	Off
29	COMP Over Current	Over inverter Compressor Current	Off

* Applied models : MU2R15 UL0 / MU2R17 UL0 / MU3R19 UE0 / MU3R21 UE0 / MU2M15 UL4 / MU2M17 UL4 / MU3M19 UE4 / MU3M21 UE4

LG MV (Monitoring View)

LG MV helps engineers to inspect and monitor air conditioning units easily.

Mobile MV

PC based LGMV (for service)

LGMV module (for service)

Operation information

Cycle View

IDU & ODU Information

Cycle & Valves

Sensors & Electricity

Cycle Diagram

Actuavtor Informationv

Forced Cooling Operation

The forced cooling operation allows refrigerant to be recharged or pumped down, regardless of the indoor temperature. More importantly this function can be used when indoor units are being moved or repaired.

Recharging

Pump Down

1

2

1 Close liquid valve
2 Close gas valve

R32 MULTI SPLIT

R32 MULTI SPLIT OUTDOOR UNITS



RESIDENTIAL

MU2R15
MU2R17



LG participates in the ECP programme for EUROVENT AC program.
Check ongoing validity of certification
: www.eurovent-certification.com

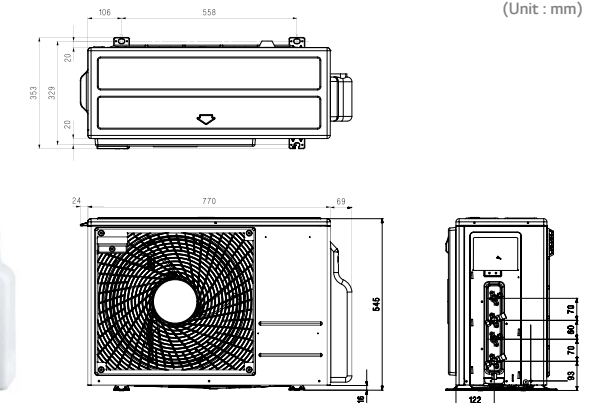

OUTDOOR UNIT				MU2R15 ULO	MU2R17 ULO
Compressor	Type			Twin Rotary	Twin Rotary
Capacity *	Cooling	Min / Nom / Max	kW	0.9 / 4.1 / 4.7	0.9 / 4.7 / 5.4
	Heating	Min / Nom / Max	kW	1.0 / 4.7 / 5.4	1.0 / 5.3 / 5.7
Low Temperature Capacity	Heating -7°C	Max	kW	3.3	3.7
Power Input *	Cooling	Min / Nom / Max	kW	0.2 / 1.0 / 1.4	0.2 / 1.3 / 1.7
	Heating	Min / Nom / Max	kW	0.2 / 1.1 / 1.4	0.2 / 1.3 / 1.6
Running Current	Cooling	Min / Nom / Max	A	1.1 / 4.6 / 6.4	1.1 / 5.6 / 7.9
	Heating	Min / Nom / Max	A	1.1 / 4.9 / 6.6	1.1 / 5.5 / 7.6
EER				4.14	3.75
COP				4.38	4.22
SEER				8.50	7.80
SCOP				4.20	4.20
Pdesign (@-10°C)			kW	4.10	4.10
Seasonal Energy Label	Cooling / Heating			A+++ (A+++ to D Scale) / A+	A++ (A++ to E Scale) / A+
Annual Energy Consumption	Cooling / Heating			169 / 1,367	210 / 1,367
Airflow Rate	Nom		m ³ /min	28.2	28.2
Sound Pressure	Cooling	Nom	dBA	48	48
	Heating	Nom	dBA	51	51
Sound Power	Cooling	Max	dBA	61	63
Dimensions	W x H x D		mm	770 x 545 x 288	770 x 545 x 288
Net Weight			Kg	36	36
Refrigerant	Type			R32	R32
	Charge		Kg	1.1	1.1
	Additional Charge		g/m	20	20
	GWP			675	675
	t-CO ₂ eq			0.74	0.74
Operation Range (Outdoor)	Cooling	Min - Max	°C DB	-10 - 48	-10 - 48
	Heating	Min - Max	°C WB	-18 - 18	-18 - 18
Power Supply			Ø / V / Hz	1 / 220-240 / 50	1 / 220-240 / 50
Power Supply Cable			No. x mm ²	3C x 2.5	3C x 2.5
Transmission Cable			No. x mm ²	4C x 0.75	4C x 0.75
Circuit Breaker			A	15	15
Piping Length Total			m	30	30
Piping Length per Branch	Max		m	20	20
Piping Elevation Difference	IDU - ODU	Max	m	15	15
	IDU - IDU	Max	m	7.5	7.5
Piping Connection	Liquid		mm (inch) x No.	Ø6.35 (1/4) x 2	Ø6.35 (1/4) x 2
	Gas		mm (inch) x No.	Ø9.52 (3/8) x 2	Ø9.52 (3/8) x 2

Notes: 1. Capacities are based on the following conditions:

Heating: - Indoor Temperature 20°C(68°F) DB/15°C(59°F) WB
- Outdoor Temperature 7°C(44.6°F) DB/6°C(42.8°F) WB

Piping Length: - Interconnecting Piping Length 7.5m
- Level Difference of Zero

2. *: See page "Combination Table".

3. Due to our policy of innovation some specifications may be changed without notification.

4. At least two indoor units should be connected

5. Minimum combination capacity rate should be more than 40%

6. This product contains fluorinated greenhouse gases (R32)

OUTDOOR UNITS



**MU3R19
MU3R21**



LG participates in the ECP programme for EUROVENT AC program.
Check ongoing validity of certification
: www.eurovent-certification.com

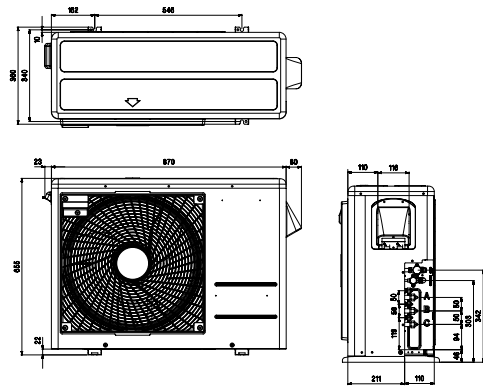

(Unit : mm)

OUTDOOR UNIT				MU3R19 UE0	MU3R21 UE0
Compressor	Type			Twin Rotary	Twin Rotary
	Cooling	Min / Nom / Max	kW	1.1 / 5.3 / 6.3	1.1 / 6.2 / 7.3
Capacity *	Heating	Min / Nom / Max	kW	1.2 / 6.3 / 7.3	1.2 / 7.0 / 7.8
	Low Temperature Capacity	Heating -7°C	Max	4.4	4.9
Power Input *	Cooling	Min / Nom / Max	kW	0.2 / 1.2 / 1.8	0.2 / 1.4 / 2.1
	Heating	Min / Nom / Max	kW	0.3 / 1.4 / 2.0	0.3 / 1.6 / 2.3
Running Current	Cooling	Min / Nom / Max	A	1.1 / 5.3 / 8.1	1.1 / 6.7 / 9.6
	Heating	Min / Nom / Max	A	1.1 / 6.3 / 9.4	1.1 / 7.4 / 10.6
EER				4.59	4.27
COP				4.62	4.42
SEER				8.50	8.50
SCOP				4.21	4.21
Pdesign (@-10°C)			kW	4.90	4.90
Seasonal Energy Label	Cooling / Heating (A+++ to D Scale)			A+++ / A+	A+++ / A+
Annual Energy Consumption	Cooling / Heating			217 / 1,629	253 / 1,629
Airflow Rate	Nom	m ³ /min		50	50
Sound Pressure	Cooling	Nom	dBA	49	50
	Heating	Nom	dBA	54	54
Sound Power	Cooling	Max	dBA	63	64
Dimensions	W x H x D		mm	870 x 655 x 320	870 x 655 x 320
	Net Weight		Kg	44	44
Refrigerant	Type			R32	R32
	Charge	Kg		1.4	1.4
	Additional Charge	g/m		20	20
	GWP			675	675
	t-CO ₂ eq			0.95	0.95
Operation Range (Outdoor)	Cooling	Min - Max	°C DB	-10 - 48	-10 - 48
	Heating	Min - Max	°C WB	-18 - 18	-18 - 18
Power Supply			Ø / V / Hz	1 / 220-240 / 50	1 / 220-240 / 50
Power Supply Cable			No. x mm ²	3C x 2.5	3C x 2.5
Transmission Cable			No. x mm ²	4C x 0.75	4C x 0.75
Circuit Breaker			A	20	20
Piping Length Total			m	50	50
Piping Length per Branch	Max	m		25	25
Piping Elevation Difference	IDU - ODU	Max	m	15	15
	IDU - IDU	Max	m	7.5	7.5
Piping Connection	Liquid	mm (inch) x No.		Ø6.35 (1/4) x 3	Ø6.35 (1/4) x 3
	Gas	mm (inch) x No.		Ø9.52 (3/8) x 3	Ø9.52 (3/8) x 3

Notes :1. Capacities are based on the following conditions:
Heating: - Indoor Temperature 20°C(68°F) DB/15°C(59°F) WB
- Outdoor Temperature 7°C(44.6°F) DB/6°C(42.8°F) WB
Piping Length: - Interconnecting Piping Length 7.5m
- Level Difference of Zero

- *: See page "Combination Table".
- Due to our policy of innovation some specifications may be changed without notification.
- At least two indoor units should be connected
- Minimum combination capacity rate should be more than 40%
- This product contains fluorinated greenhouse gases (R32)

**MU4R25
MU4R27
MU5R30**



LG participates in the ECP programme for EUROVENT AC program.
Check ongoing validity of certification
: www.eurovent-certification.com

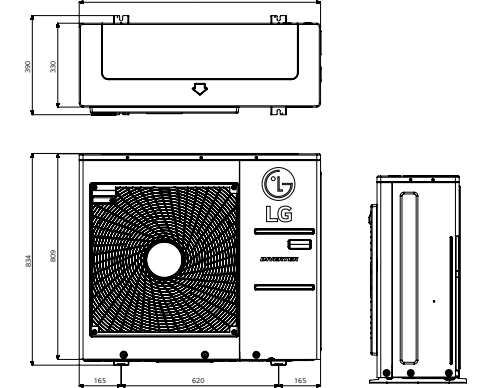

(Unit : mm)

OUTDOOR UNIT				MU4R25 U40	MU4R27 U40	MU5R30 U40
Compressor	Type			Twin Rotary	Twin Rotary	Twin Rotary
	Cooling	Min / Nom / Max	kW	1.3 / 7.0 / 8.5	1.3 / 7.9 / 9.5	1.3 / 8.8 / 10.6
Capacity *	Heating	Min / Nom / Max	kW	1.5 / 8.4 / 9.4	1.5 / 9.1 / 10.6	1.5 / 10.1 / 12.1
	Low Temperature Capacity	Heating -7°C	Max	5.9	6.4	7.1
Power Input *	Cooling	Min / Nom / Max	kW	0.4 / 1.5 / 2.6	0.4 / 1.8 / 2.9	0.4 / 2.0 / 3.4
	Heating	Min / Nom / Max	kW	0.6 / 1.8 / 2.9	0.6 / 2.1 / 3.4	0.6 / 2.2 / 3.6
Running Current	Cooling	Min / Nom / Max	A	1.9 / 6.6 / 11.9	1.9 / 8.1 / 13.1	1.9 / 9.1 / 15.2
	Heating	Min / Nom / Max	A	2.8 / 8.3 / 13.1	2.8 / 9.4 / 15.3	2.8 / 9.7 / 16.3
EER				4.82	4.39	4.40
COP				4.61	4.39	4.70
SEER				8.20	8.00	8.20
SCOP				4.20	4.20	4.20
Pdesign (@-10°C)			kW	7.00	7.00	7.20
Seasonal Energy Label	Cooling / Heating (A++ to E Scale)			A++ / A+	A++ / A+	A++ / A+
Annual Energy Consumption	Cooling / Heating			299 / 2,333	346 / 2,333	376 / 2,467
Airflow Rate	Nom	m ³ /min		60	60	60
Sound Pressure	Cooling	Nom	dBA	49	50	50
	Heating	Nom	dBA	53	54	54
Sound Power	Cooling	Max	dBA	64	65	66
Dimensions	W x H x D		mm	950 x 834 x 330	950 x 834 x 330	950 x 834 x 330
	Net Weight		Kg	61	61	61
Refrigerant	Type			R32	R32	R32
	Charge	Kg		2.3	2.3	2.6
	Additional Charge	g/m		20	20	20
	GWP			675	675	675
	t-CO ₂ eq			1.55	1.55	1.76
Operation Range (Outdoor)	Cooling	Min - Max	°C DB	-10 - 48	-10 - 48	-10 - 48
	Heating	Min - Max	°C WB	-18 - 18	-18 - 18	-18 - 18
Power Supply			Ø / V / Hz	1 / 220-240 / 50	1 / 220-240 / 50	1 / 220-240 / 50
Power Supply Cable			No. x mm ²	3C x 2.5	3C x 2.5	3C x 2.5
Transmission Cable			No. x mm ²	4C x 0.75	4C x 0.75	4C x 0.75
Circuit Breaker			A	25	25	25
Piping Length Total			m	70	70	75
Piping Length per Branch	Max	m		25	25	25
Piping Elevation Difference	IDU - ODU	Max	m	15	15	15
	IDU - IDU	Max	m	7.5	7.5	7.5
Piping Connection	Liquid	mm(inch) x No.		Ø6.35 (1/4) x 4	Ø6.35 (1/4) x 4	Ø6.35 (1/4) x 5
	Gas	mm(inch) x No.		Ø9.52 (3/8) x 4	Ø9.52 (3/8) x 4	Ø9.52 (3/8) x 5

Notes :1. Capacities are based on the following conditions:
Heating: - Indoor Temperature 20°C(68°F) DB/15°C(59°F) WB
- Outdoor Temperature 7°C(44.6°F) DB/6°C(42.8°F) WB
Piping Length: - Interconnecting Piping Length 7.5m
- Level Difference of Zero

- *: See page "Combination Table".
- Due to our policy of innovation some specifications may be changed without notification.
- At least two indoor units should be connected
- Minimum combination capacity rate should be more than 40%
- This product contains fluorinated greenhouse gases (R32)

WALL MOUNTED UNITS



Embedded Wi-Fi

Control your air conditioners via using the smart internet devices as Android or iOS based smartphones. This advanced technology provides you the best convenience.

• LG Smart ThinQ

Search "LG Smart ThinQ" on Google market or Appstore then download the app.



LG Smart ThinQ



• How it Works

Embedded Wi-Fi modem

Check "LG Smart ThinQ" on your air conditioner.



By embedded Wi-Fi modem, get ready for innovation without boundaries.



Easy Registration and Log-in

Follow the easy set-up steps that will activate smart ThinQ's impressive feature.

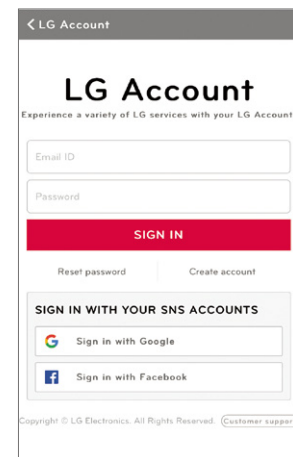

Wi-Fi Connectivity

Let's every member of your family choose their own preferred air conditioning temperature and fan speed, then save the settings in their app to run later. You can save the setting for each air conditioner as well.

Multiple Devices



Multi-Control



* Can be controlled by multiple users, but not simultaneously

• Benefit

Simple operation for various functions

On/Off, Current Temp

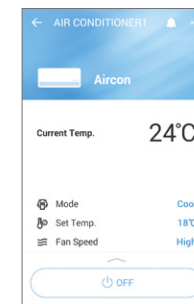

Mode, Set Temp

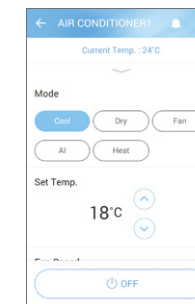

Vane Control

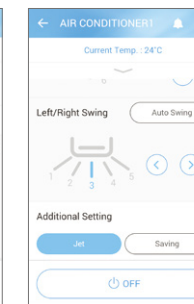
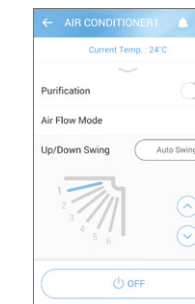

Straight forward Management

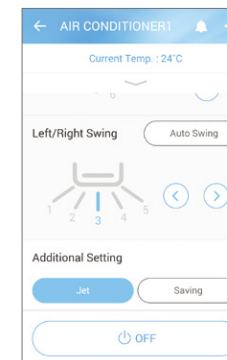

Reservation



Energy Monitoring

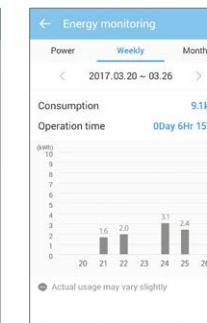

Smart Diagnosis



Filter Management

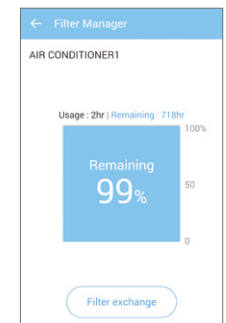

Integrated Home Appliances Control

Control / Monitor all your LG appliances from one place.



Access your air conditioner anytime and from anywhere

with a Wi-Fi equipped device and LG's exclusive control app, Smart ThinQ.



WALL MOUNTED UNITS



Plasmaster™ Ionizer^{PLUS}

The powerful plasma ionizer protects you from odors and harmful substances in the air with over 3 million ions to sterilize not only the air passing through the air conditioner, but also surrounding surfaces for a safer, cleaner environment.

* Specifications may vary for each model.
* Depending on the experimental conditions.

• How It Works

Sterilization and Deodorization (Utilizes Over 3 Million Ions)

Plasmaster Ionizer+ reduces harmful microscopic particles by infusing the air passing through the air conditioner with over 3 millions ions.

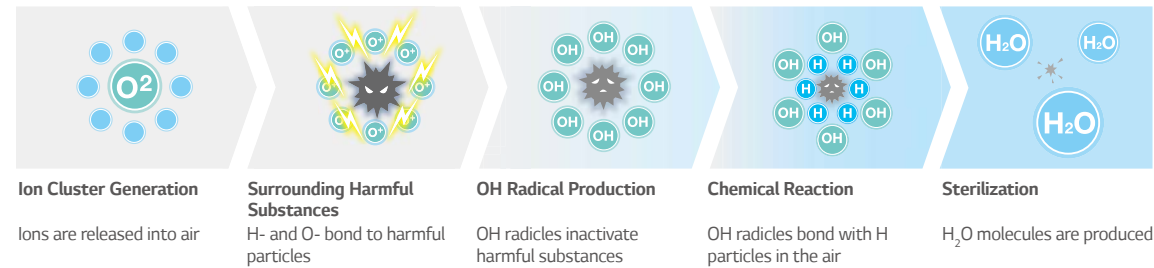

• Test Result

Sterilization Performance Evaluations

Sterilize Bacteria (E.coli colon bacillus) over 99.9% in 30 min.

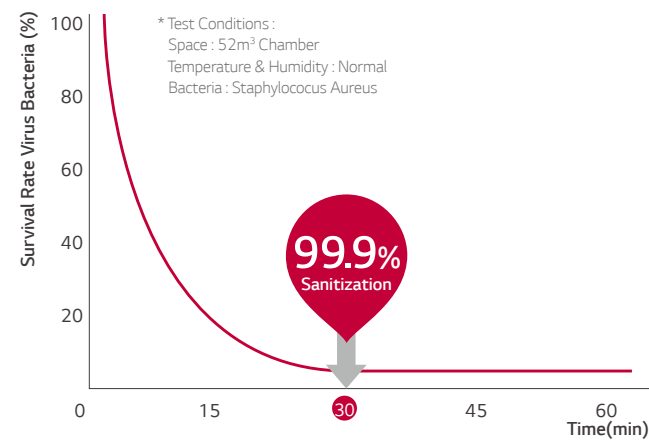

2.1 odor strength decrease in 60 minutes

An odor of strength 2 or less indicates that there is odor but no sense of displeasure (degree of odor permissible).

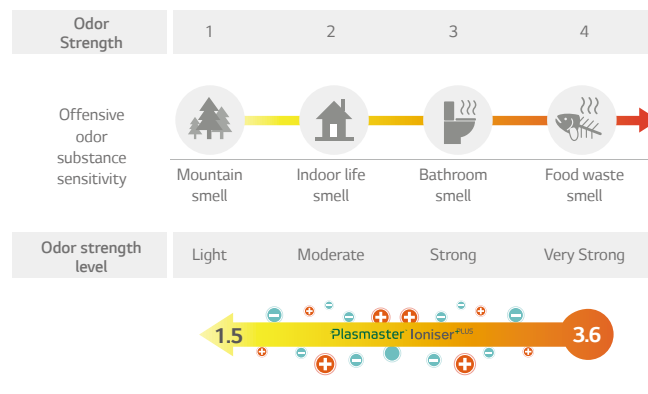

Quick & Easy Installation

LG air conditioner is designed for an easy and efficient installation, making possible to install several units in a short period of time

* Specifications may vary for each model.

• Concept

By reducing the manpower and time required for installation, it is now possible to install more units in less time.

• How It Works

One Simple Packing Box

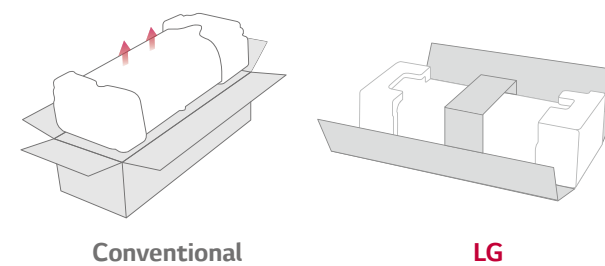

Installation Plate Improvement

LG's installation plate is larger and customized to reduce installation time.

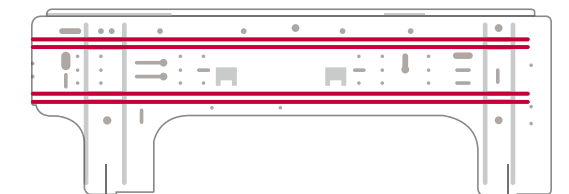

Installation Support Clip

A support clip creates adequate space between the wall and the unit for easier installation.

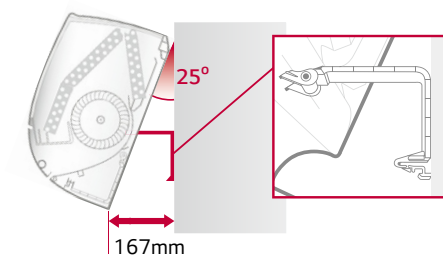

Wider Tubing Space

The space provided for tubing facilitates the whole installation process and hides the unorganized parts, making it appear clean and tidy.

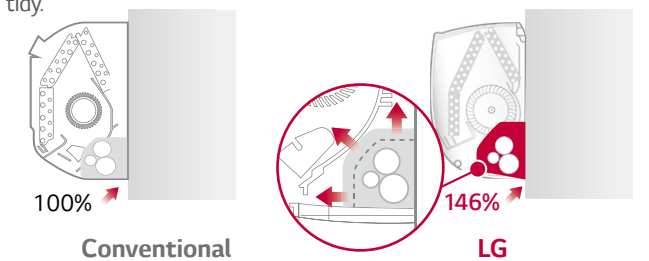

Detachable Bottom Cover

The air conditioner's bottom cover is detachable for easier installation and access.

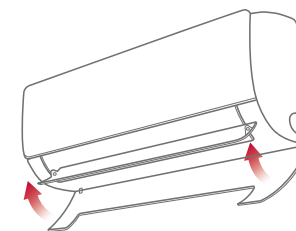

Quick button for running test

The test button is conveniently located and easy to find.

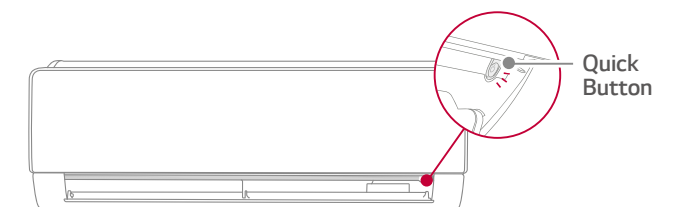

WALL MOUNTED UNITS



		kBtu/h	05	07	09	12	15	18	24
		kW	1.5	2.1	2.6	3.5	4.2	5.3	7.0
Wall Mounted Unit	ARTCOOL		-	● AM07BP	● AM09BP	● AM12BP	-	● AM18BP	● AM24BP
	Deluxe		-	● DM07RP	● DC09RQ	● DC12RQ	-	● DC18RQ	● DM24RP

ARTCOOL

				AM07BP NSJ	AM09BP NSJ	AM12BP NSJ	AM18BP NSK	AM24BP NSK
Capacity	Cooling / Heating	Nom	kW	2.1 / 2.3	2.5 / 3.2	3.5 / 3.8	5.0 / 5.8	6.6 / 7.5
Power Input		Nom	W	17	18	19	39	45
Running Current		Nom	A	0.14	0.16	0.17	0.28	0.33
Power Supply		Ø / V / Hz		1 / 220-240 / 50	1 / 220-240 / 50	1 / 220-240 / 50	1 / 220-240 / 50	1 / 220-240 / 50
Air Flow Rate		H / M / L	m ³ /min	8.6 / 7.2 / 5.6	9.2 / 7.4 / 5.6	9.6 / 8.1 / 5.6	14.2 / 11.3 / 9.9	15.2 / 12.7 / 10.2
Sound Pressure		H / M / L	dB(A)	35 / 32 / 27	36 / 33 / 27	40 / 35 / 27	44 / 38 / 35	46 / 41 / 36
Sound Power			dB(A)	57	57	57	59	65
Dehumidification Rate			l/h	0.9	1.1	1.2	1.9	2.6
Dimension		W x H x D	mm	837 x 308 x 192	837 x 308 x 192	837 x 308 x 192	998 x 345 x 212	998 x 345 x 212
Net weight			kg	9.1	9.9	9.9	13.2	11.6
Piping	Liquid		mm (inch)	Ø 6.35 (1/4)	Ø 6.35 (1/4)	Ø 6.35 (1/4)	Ø 6.35 (1/4)	Ø 6.35 (1/4)
Connection	Gas		mm (inch)	Ø 9.52 (3/8)	Ø 9.52 (3/8)	Ø 9.52 (3/8)	Ø 12.7 (1/2)	Ø 12.7 (1/2)

DELUXE

				DM07RP NSJ	DC09RQ NSJ	DC12RQ NSJ	DC18RQ NSK	DM24RP NSK
Capacity	Cooling / Heating	Nom	kW	2.1 / 2.3	2.5 / 3.2	3.5 / 4.0	5.0 / 5.8	6.6 / 7.5
Power Input		Nom	W	17	18	19	39	45
Running Current		Nom	A	0.15	0.16	0.17	0.28	0.33
Power Supply		Ø / V / Hz		1 / 220-240 / 50	1 / 220-240 / 50	1 / 220-240 / 50	1 / 220-240 / 50	1 / 220-240 / 50
Air Flow Rate		H / M / L	m ³ /min	7.5 / 6.1 / 4.9	7.7 / 6.4 / 5.0	8.1 / 6.7 / 5.3	14.2 / 11.3 / 9.9	15.2 / 12.7 / 10.2
Sound Pressure		H / M / L	dB(A)	35 / 31 / 26	36 / 32 / 27	38 / 34 / 29	44 / 38 / 34	47 / 41 / 36
Sound Power			dB(A)	56	56	56	60	64
Dehumidification Rate			l/h	0.9	1.1	1.2	1.9	2.6
Dimension		W x H x D	mm	837 x 308 x 189	837 x 308 x 189	837 x 308 x 189	998 x 345 x 210	998 x 345 x 210
Net weight			kg	8.3	8.3	8.3	12.0	12.0
Piping	Liquid		mm (inch)	Ø 6.35 (1/4)	Ø 6.35 (1/4)	Ø 6.35 (1/4)	Ø 6.35 (1/4)	Ø 6.35 (1/4)
Connection	Gas		mm (inch)	Ø 9.52 (3/8)	Ø 9.52 (3/8)	Ø 9.52 (3/8)	Ø 12.7 (1/2)	Ø 12.7 (1/2)

* Preliminary Data

		kBtu/h	05	07	09	12	15	18	24	
		kW	1.5	2.1	2.6	3.5	4.2	5.3	7.0	
Wall Mounted Unit	Standard Plus		-	● PM05SP	● PM07SP	● PC09SQ	● PC12SQ	● PM15SP	● PC18SQ	● PM24SP
			-	● MJ05PC	● MJ07PC	● MJ09PC	● MJ12PC	● MJ15PC	● MJ18PC	● MJ24PC

STANDARD PLUS

				PM05SP NSJ	PM07SP NSJ	PC09SQ NSJ	PC12SQ NSJ	PM15SP NSJ	PC18SQ NSK	PM24SP NSK
Capacity	Cooling / Heating	Nom	kW	1.5 / 1.6	2.1 / 2.3	2.5 / 3.2	3.5 / 3.8	4.2 / 5.4	5.0 / 5.8	6.6 / 7.5
Power Input		Nom	W	16	17	18	19	21	39	45
Running Current		Nom	A	0.13	0.14	0.16	0.17	0.18	0.28	0.33
Power Supply		Ø / V / Hz		1 / 220-240 / 50	1 / 220-240 / 50	1 / 220-240 / 50	1 / 220-240 / 50	1 / 220-240 / 50	1 / 220-240 / 50	1 / 220-240 / 50
Air Flow Rate		H / M / L	m ³ /min	8.3 / 6.7 / 5.6	8.6 / 7.2 / 5.6	9.2 / 7.4 / 5.6	9.6 / 8.1 / 5.6	10.0 / 8.5 / 6.1	14.2 / 11.3 / 9.9	15.2 / 12.7 / 10.2
Sound Pressure		H / M / L	dB(A)	34 / 31 / 27	35 / 32 / 27	36 / 33 / 27	40 / 35 / 27	41 / 36 / 29	44 / 38 / 35	46 / 41 / 36
Sound Power			dB(A)	57	57	57	57	57	59	65
Dehumidification Rate			l/h	0.9	0.9	1.1	1.2	1.2	1.9	2.6
Dimension		W x H x D	mm	837 x 308 x 189	837 x 308 x 189	837 x 308 x 189	837 x 308 x 189	837 x 308 x 189	998 x 345 x 210	998 x 345 x 210
Net weight			kg	8.7	8.7	8.7	8.7	8.7	12.0	12.8
Piping	Liquid		mm (inch)	Ø 6.35 (1/4)	Ø 6.35 (1/4)	Ø 6.35 (1/4)	Ø 6.35 (1/4)	Ø 6.35 (1/4)	Ø 6.35 (1/4)	Ø 6.35 (1/4)
Connection	Gas		mm (inch)	Ø 9.52 (3/8)	Ø 9.52 (3/8)	Ø 9.52 (3/8)	Ø 9.52 (3/8)	Ø 9.52 (3/8)	Ø 12.7 (1/2)	Ø 12.7 (1/2)

				MJ05PC NSJ	MJ07PC NSJ	MJ09PC NSJ	MJ12PC NSJ	MJ15PC NSJ	MJ18PC NSK	MJ24PC NSK
Capacity	Cooling / Heating	Nom	kW	1.5 / 1.6	2.1 / 2.3	2.5 / 3.2	3.5 / 3.8	4.2 / 5.4	5.0 / 5.8	6.6 / 7.5
Power Input		Nom	W	16	17	18	19	21	39	45
Running Current		Nom	A	0.13	0.14	0.16	0.17	0.18	0.28	0.33
Power Supply		Ø / V / Hz		1 / 220-240 / 50	1 / 220-240 / 50	1 / 220-240 / 50	1 / 220-240 / 50	1 / 220-240 / 50	1 / 220-240 / 50	1 / 220-240 / 50
Air Flow Rate		H / M / L	m ³ /min	8.3 / 6.7 / 5.6	8.6 / 7.2 / 5.6	9.2 / 7.4 / 5.6	9.6 / 8.1 / 5.6	10.0 / 8.5 / 6.1	14.2 / 11.3 / 9.9	15.2 / 12.7 / 10.2
Sound Pressure		H / M / L	dB(A)	34 / 31 / 27	35 / 32 / 27	36 / 33 / 27	40 / 35 / 27	41 / 36 / 29	44 / 38 / 35	46 / 41 / 36
Sound Power			dB(A)	57	57	57	57	57	59	65
Dehumidification Rate			l/h	0.9	0.9	1.1	1.2	1.2	1.9	2.6
Dimension		W x H x D	mm	837 x 308 x 189	837 x 308 x 189	837 x 308 x 189	837 x 308 x 189	837 x 308 x 189	998 x 345 x 210	998 x 345 x 210
Net weight			kg	8.7	8.7	8.7	8.7	8.7	12.0	12.8
Piping	Liquid		mm (inch)	Ø 6.35 (1/4)	Ø 6.35 (1/4)	Ø 6.35 (1/4)	Ø 6.35 (1/4)	Ø 6.35 (1/4)	Ø 6.35 (1/4)	Ø 6.35 (1/4)
Connection	Gas		mm (inch)	Ø 9.52 (3/8)	Ø 9.52 (3/8)	Ø 9.52 (3/8)	Ø 9.52 (3/8)	Ø 9.52 (3/8)	Ø 12.7 (1/2)	Ø 12.7 (1/2)

* Preliminary Data

CEILING MOUNTED CASSETTE



Human detect sensor & humidity sensor

Human detection sensor

Apply human detection sensor
Apply vision sensor
- Saving energy
- Supply comfortable flow

Comfortable and Power Saving Control based on Humidity
Apply humidity sensor
- Saving energy

• Detection

Checking no. of people and movement per 20seconds



• Detection range

Height 3.2 (15 x 8m)

Height 3.5 (16 x 10m)

A sensor is installed 90° rotation
12 x 6m → 6 x 12m detecting

Convenient Panel Installation

The detachable corner design makes it easy to adjust the hanger during installation and to check for leakages in the drain connection pipe.

Detachable Corner Design

Refrigerant piping check and Hanger adjust

Drain leakage check and hanger adjust

Hanger adjust

Hanger adjust

Drain Leakage Check

Hanger Adjust

It is easy to install the panel to the body, using the button type panel design.

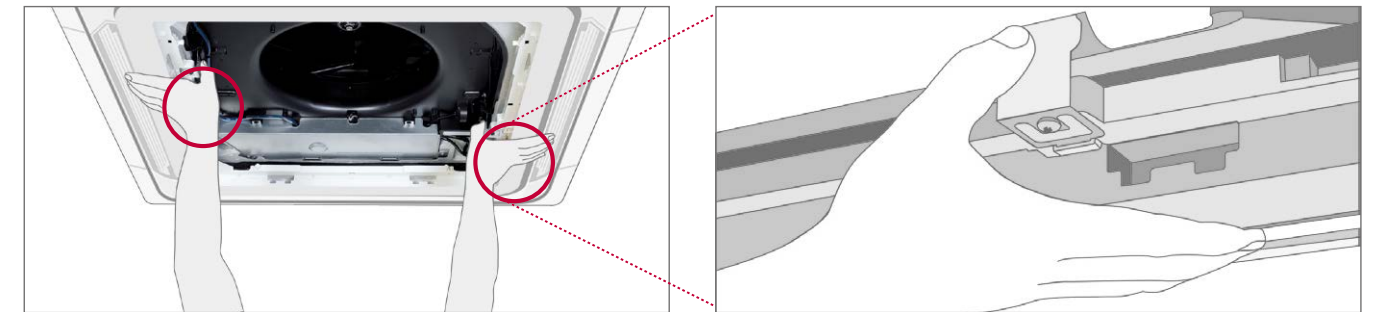

	kBtu/h	05	07	09	12	15	18	24
	kW	1.5	2.1	2.6	3.5	4.2	5.3	7.0
Ceiling Mounted Cassette	4 Way Cassette	MT06R	MT08R	CT09R	CT12R	-	CT18R	CT24R

Cassette

				MT06R NRO	MT08R NRO	CT09R NRO	CT12R NRO	CT18R NQO	CT24R NP0
Capacity	Cooling / Heating	Nom	kW	1.5 / 1.6	2.1 / 2.3	2.6 / 2.9	3.5 / 3.9	5.3 / 5.8	6.7 / 7.5
Power Input		Nom	W	20	20	20	20	40	60
Running Current		Nom	A	0.40	0.40	0.40	0.40	0.40	0.60
Power Supply			Ø / V / Hz	1 / 220-240 / 50	1 / 220-240 / 50	1 / 220-240 / 50	1 / 220-240 / 50	1 / 220-240 / 50	1 / 220-240 / 50
Air Flow Rate		H / M / L	m ³ /min	7.5 / 6.0 / 5.0	7.5 / 6.0 / 5.0	8.5 / 7.0 / 6.0	9.5 / 8.0 / 7.0	13.0 / 12.0 / 11.0	17.0 / 15.0 / 13.0
Sound Pressure		H / M / L	dB(A)	31 / 27 / 24	31 / 27 / 24	36 / 33 / 30	38 / 35 / 32	41 / 39 / 36	38 / 36 / 34
Sound Power			dB(A)	48	48	52	52	57	57
Dehumidification Rate			l/h	-	-	0.9	1.4	2.0	2.7
Dimension		W x H x D	mm	570 x 214 x 570	570 x 214 x 570	570 x 214 x 570	570 x 214 x 570	570 x 256 x 570	840 x 204 x 840
Net weight			kg	14.0	14.0	14.0	14.0	14.3	20.5
Piping Connection	Liquid		mm (inch)	Ø6.35 (1/4)	Ø6.35 (1/4)	Ø6.35 (1/4)	Ø6.35 (1/4)	Ø6.35 (1/4)	Ø6.35 (1/4)
	Gas		mm (inch)	Ø9.52 (3/8)	Ø9.52 (3/8)	Ø9.52 (3/8)	Ø9.52 (3/8)	Ø12.7 (1/2)	Ø12.7 (1/2)
Decoration Panel	Model			PT-QCHW0	PT-QCHW0	PT-MCHW0	PT-MCHW0	PT-MCHW0	PT-MCHW0
	Color			Morning Fog (RAL 120-4)					
	Dimensions	W x H x D	mm	620 x 20 x 620	620 x 20 x 620	620 x 20 x 620	620 x 20 x 620	620 x 20 x 620	950 x 35 x 950
	Weight		kg	3.0	3.0	3.0	3.0	3.0	6.3

CEILING CONCEALED DUCT



E.S.P. (External Static Pressure) Control

E.S.P. control function can make air volume controlled easily with remote controller. The BLDC motor can control fan speed and air volume regardless of the external static pressure. No additional accessories are necessary to control air flow.

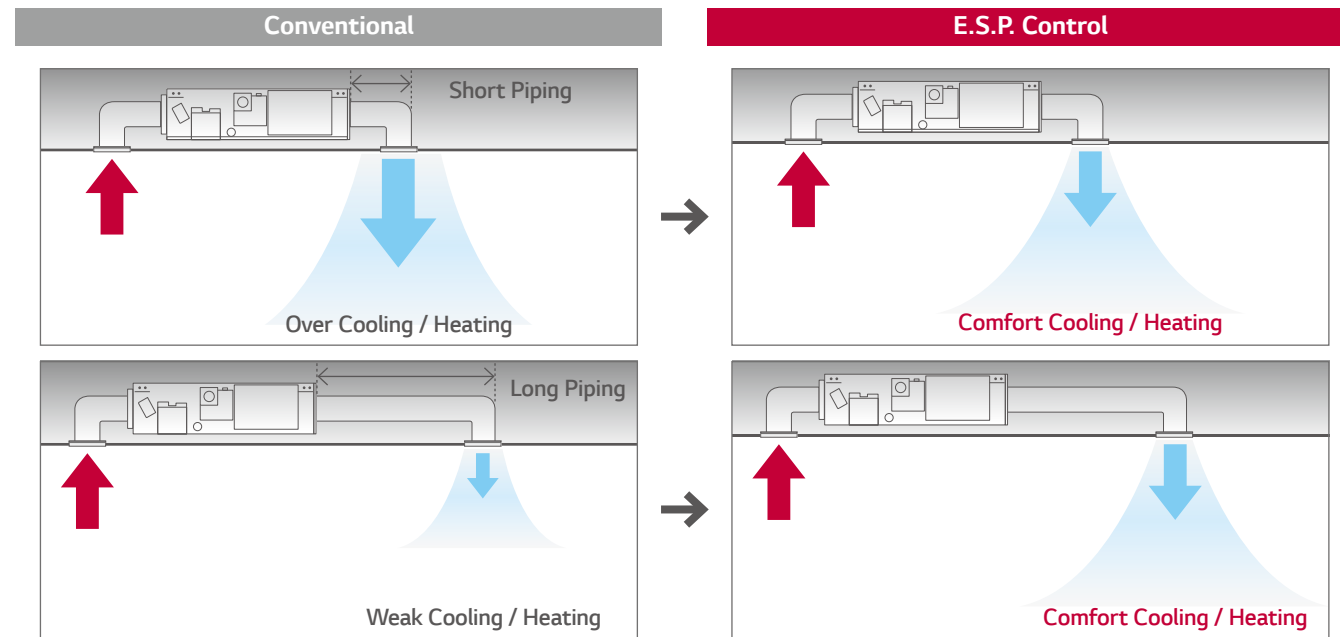

High Head Drain Pump

High head drain pump automatically drains water up to 200mm of drain-head height. It provides perfect solution for water drainage. (H-Inverter : Included / Standard Inverter : Accessory (ABDPG) / Low-Static Duct : Included)

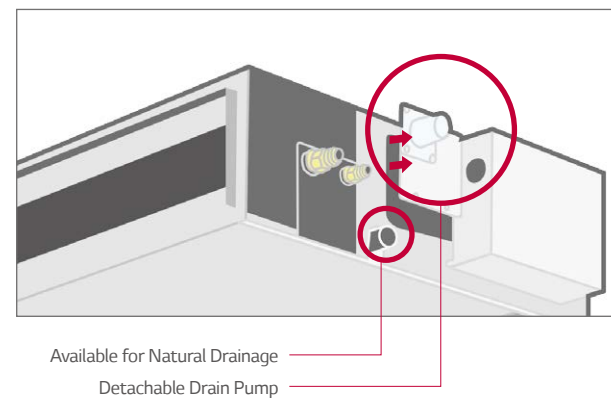
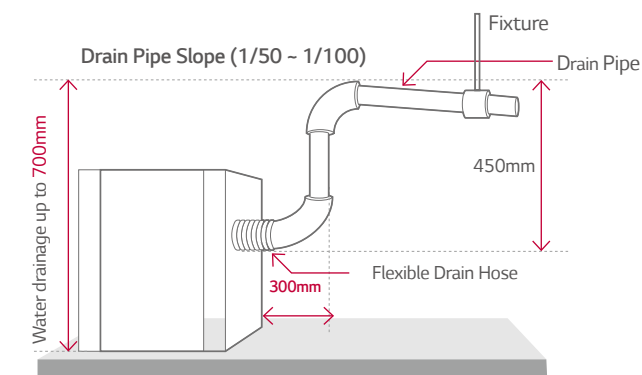

		05	07	09	12	15	18	24	
		kW	1.5	2.1	2.6	3.5	4.2	5.3	7.0
Ceiling Concealed Duct	Mid / High Static Pressure		-	-	-	-	●	●	●
	Low Static Pressure		-	-	●	●	-	●	●

Duct (Mid Static)

				CM18R N10	CM24R N10
Capacity	Cooling / Heating	Nom	kW	5.3 / 5.8	7.0 / 7.7
Power Input		Nom	W	160	180
Running Current		Nom	A	0.90	1.00
Power Supply			Ø / V / Hz	1 / 220-240 / 50	1 / 220-240 / 50
Air Flow Rate		H / M / L	m ³ /min	16.5 / 14.5 / 13.0	18.0 / 16.5 / 14.5
Sound Pressure		H / M / L	dB(A)	34 / 32 / 30	35 / 34 / 32
Sound Power			dB(A)	59	60
Dehumidification Rate			l/h	1.5	2.5
Dimension		W x H x D	mm	900 x 270 x 700	900 x 270 x 700
Net weight			kg	26.5	26.5
Piping	Liquid		mm (inch)	Ø6.35 (1/4)	Ø6.35 (1/4)
Connection	Gas		mm (inch)	Ø12.7 (1/2)	Ø12.7 (1/2)
External Static Pressure	Min-Max		mmAq (Pa)	2-15 (20-147)	2-15 (20-147)

Duct (Low Static)

				CL09R N20	CL12R N20	CL18R N20	CL24R N30
Capacity	Cooling / Heating	Nom	kW	2.6 / 2.9	3.5 / 3.9	5.3 / 5.8	7.0 / 7.7
Power Input		Nom	W	100	100	140	160
Running Current		Nom	A	0.80	0.80	0.80	1.00
Power Supply			Ø / V / Hz	1 / 220-240 / 50	1 / 220-240 / 50	1 / 220-240 / 50	1 / 220-240 / 50
Air Flow Rate		H / M / L	m ³ /min	10.0 / 8.5 / 7.0	10.0 / 8.5 / 7.0	15.0 / 12.5 / 10.0	20.0 / 16.0 / 12.0
Sound Pressure		H / M / L	dB(A)	31 / 28 / 27	31 / 28 / 27	36 / 34 / 31	39 / 35 / 32
Sound Power			dB(A)	55	55	54	58
Dehumidification Rate			l/h	0.55	1.11	1.58	2.65
Dimension		W x H x D	mm	900 x 190 x 700	900 x 190 x 700	900 x 190 x 700	1,100 x 190 x 700
Net weight			kg	24.0	24.0	24.0	27.0
Piping	Liquid		mm (inch)	Ø6.35 (1/4)	Ø6.35 (1/4)	Ø6.35 (1/4)	Ø6.35 (1/4)
Connection	Gas		mm (inch)	Ø9.52 (3/8)	Ø9.52 (3/8)	Ø12.7 (1/2)	Ø12.7 (1/2)
External Static Pressure	Min-Max		mmAq (Pa)	0-5 (0-50)	0-5 (0-50)	0-5 (0-50)	0-5 (0-50)

R410A MULTI SPLIT



R410A MULTI SPLIT OUTDOOR UNITS

MU2M15
MU2M17



LG participates in the ECP programme for EUROVENT AC program.
Check ongoing validity of certification
: www.eurovent-certification.com

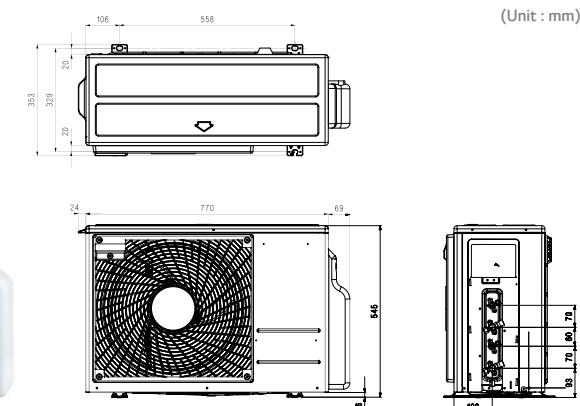

OUTDOOR UNIT				MU2M15 UL4	MU2M17 UL4
Compressor	Type			Twin Rotary	Twin Rotary
Capacity *	Cooling	Min / Nom / Max	kW	0.9 / 4.1 / 4.7	0.9 / 4.7 / 5.4
	Heating	Min / Nom / Max	kW	1.0 / 4.7 / 5.4	1.0 / 5.3 / 5.7
Low Temperature Capacity	Heating -7°C	Max	kW	3.3	3.7
Power Input *	Cooling	Min / Nom / Max	kW	0.2 / 1.0 / 1.4	0.2 / 1.3 / 1.7
	Heating	Min / Nom / Max	kW	0.2 / 1.1 / 1.5	0.2 / 1.2 / 1.7
Running Current	Cooling	Min / Nom / Max	A	1.1 / 4.6 / 6.4	1.1 / 5.6 / 7.9
	Heating	Min / Nom / Max	A	1.1 / 4.9 / 6.7	1.1 / 5.5 / 7.6
EER				4.15	3.75
COP				4.40	4.25
SEER				7.60	7.50
SCOP				4.20	4.20
Pdesign (@-10°C)			kW	4.1	4.1
Seasonal Energy Label	Cooling / Heating (A++ to E Scale)			A++ / A+	A++ / A+
Annual Energy Consumption	Cooling / Heating			189 / 1,367	219 / 1,367
Airflow Rate	Nom		m ³ /min	28.2	28.2
Sound Pressure	Cooling	Nom	dBA	48	48
	Heating	Nom	dBA	51	51
Sound Power	Cooling	Max	dBA	61	63
Dimensions	W x H x D		mm	770 x 545 x 288	770 x 545 x 288
Net Weight			Kg	37	37
Refrigerant	Type			R410A	R410A
	Charge		Kg	1.4	1.4
	Additional Charge		g/m	20	20
	GWP			2,087.5	2,087.5
Operation Range (Outdoor)	Cooling	Min - Max	°C DB	-10 - 48	-10 - 48
	Heating	Min - Max	°C WB	-18 - 18	-18 - 18
Power Supply			Ø / V / Hz	1 / 220-240 / 50	1 / 220-240 / 50
Power Supply Cable			No. x mm ²	3C x 2.5	3C x 2.5
Transmission Cable			No. x mm ²	4C x 0.75	4C x 0.75
Circuit Breaker			A	15	15
Piping Length Total			m	30	30
Piping Length per Branch		Max	m	20	20
Piping Elevation Difference	IDU - ODU	Max	m	15	15
	IDU - IDU	Max	m	7.5	7.5
Piping Connection	Liquid		mm(inch) x No.	Ø6.35 (1/4) x 2	Ø6.35 (1/4) x 2
	Gas		mm(inch) x No.	Ø9.52 (3/8) x 2	Ø9.52 (3/8) x 2

- Notes: 1. Capacities are based on the following conditions
 Heating: - Indoor Temperature 20°C(68°F) DB/15°C(59°F) WB
 - Outdoor Temperature 7°C(44.6°F) DB/6°C(42.8°F) WB
 Piping Length: - Interconnecting Piping Length 7.5m
 - Level Difference of Zero
 2. *: See page "Combination Table".
 3. Due to our policy of innovation some specifications may be changed without notification.
 4. At least two indoor units should be connected
 5. Minimum combination capacity rate should be more than 40%
 6. This product contains fluorinated greenhouse gases (R410A)

OUTDOOR UNITS

MU3M19
MU3M21



LG participates in the ECP programme for EUROVENT AC program.
Check ongoing validity of certification
: www.eurovent-certification.com

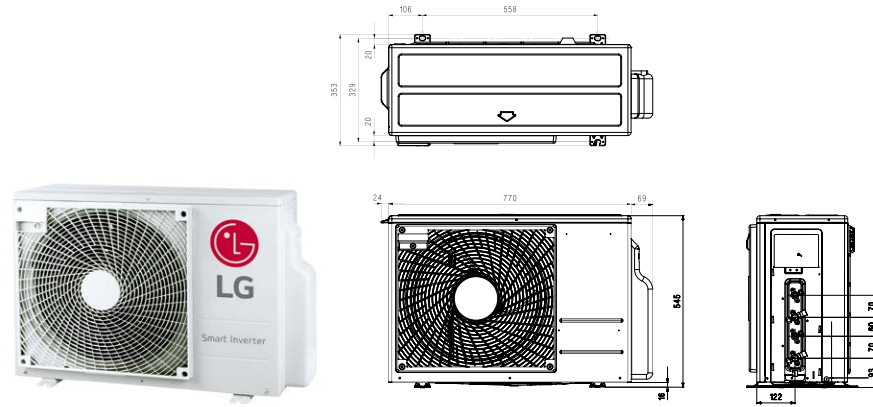

MU4M25
MU4M27
MU5M30



LG participates in the ECP programme for EUROVENT AC program.
Check ongoing validity of certification
: www.eurovent-certification.com

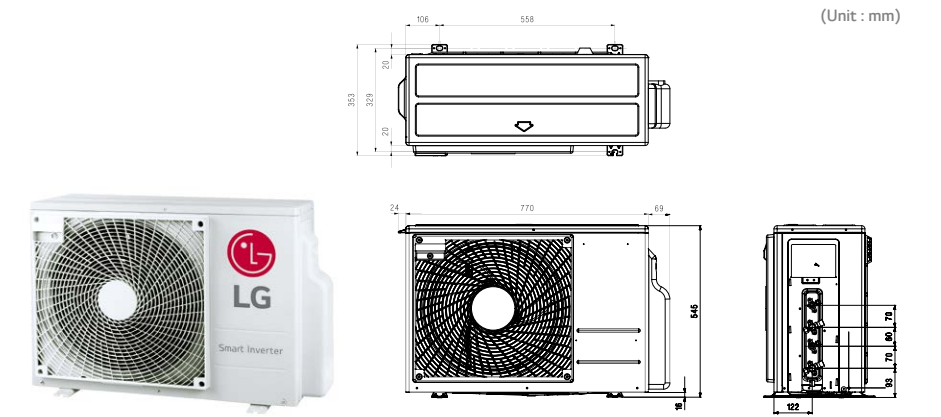

(Unit : mm)

OUTDOOR UNIT				MU3M19 UE4	MU3M21 UE4
Compressor	Type			Twin Rotary	Twin Rotary
Capacity *	Cooling	Min / Nom / Max	kW	1.1 / 5.3 / 6.3	1.1 / 6.2 / 7.3
	Heating	Min / Nom / Max	kW	1.2 / 6.3 / 7.3	1.2 / 7.0 / 7.8
Low Temperature Capacity	Heating -7°C	Max	kW	4.4	4.9
Power Input *	Cooling	Min / Nom / Max	kW	0.3 / 1.3 / 1.8	0.3 / 1.6 / 2.2
	Heating	Min / Nom / Max	kW	0.3 / 1.5 / 2.1	0.3 / 1.7 / 2.4
Running Current	Cooling	Min / Nom / Max	A	1.2 / 5.8 / 8.7	1.2 / 7.2 / 10.0
	Heating	Min / Nom / Max	A	1.2 / 6.8 / 9.7	1.2 / 7.7 / 11.0
EER				4.20	4.00
COP				4.30	4.20
SEER				7.60	7.30
SCOP				4.21	4.21
Pdesign (@-10°C)			kW	5.2	5.2
Seasonal Energy Label	Cooling / Heating (A++ to E Scale)			A++ / A+	A++ / A+
Annual Energy Consumption	Cooling / Heating			243 / 1,729	283 / 1,729
Airflow Rate	Nom		m ³ /min	50	50
Sound Pressure	Cooling	Nom	dBA	49	50
	Heating	Nom	dBA	54	54
Sound Power	Cooling	Max	dBA	63	64
Dimensions	W x H x D		mm	870 x 655 x 320	870 x 655 x 320
Net Weight			Kg	45	45
Refrigerant	Type			R410A	R410A
	Charge		Kg	1.7	1.7
	Additional Charge		g/m	20	20
	GWP			2,087.5	2,087.5
	t-CO ₂ eq			3.5	3.5
Operation Range (Outdoor)	Cooling	Min - Max	°C DB	-10 - 48	-10 - 48
	Heating	Min - Max	°C WB	-18 - 18	-18 - 18
Power Supply			Ø / V / Hz	1 / 220-240 / 50	1 / 220-240 / 50
Power Supply Cable			No. x mm ²	3C x 2.5	3C x 2.5
Transmission Cable			No. x mm ²	4C x 0.75	4C x 0.75
Circuit Breaker			A	20	20
Piping Length Total			m	50	50
Piping Length per Branch	Max		m	25	25
Piping Elevation Difference	IDU - ODU	Max	m	15	15
	IDU - IDU	Max	m	7.5	7.5
Piping Connection	Liquid		mm(inch) x No.	Ø6.35 (1/4) x 3	Ø6.35 (1/4) x 3
	Gas		mm(inch) x No.	Ø9.52 (3/8) x 3	Ø9.52 (3/8) x 3

Notes :1. Capacities are based on the following conditions
Heating: - Indoor Temperature 20°C(68°F) DB/15°C(59°F) WB
- Outdoor Temperature 7°C(44.6°F) DB/6°C(42.8°F) WB
Piping Length: - Interconnecting Piping Length 7.5m
- Level Difference of Zero
2. *: See page "Combination Table".
3. Due to our policy of innovation some specifications may be changed without notification.
4. At least two indoor units should be connected
5. Minimum combination capacity rate should be more than 40%
6. This product contains fluorinated greenhouse gases (R410A)

OUTDOOR UNIT				MU4M25 U44	MU4M27 U44	MU5M30 U44
Compressor	Type			Twin Rotary	Twin Rotary	Twin Rotary
Capacity *	Cooling	Min / Nom / Max	kW	1.3 / 7.0 / 8.5	1.3 / 7.9 / 9.5	1.3 / 8.8 / 10.6
	Heating	Min / Nom / Max	kW	1.5 / 8.4 / 9.4	1.5 / 9.1 / 10.6	1.5 / 10.1 / 12.1
Low Temperature Capacity	Heating -7°C	Max	kW	5.9	6.4	7.1
Power Input *	Cooling	Min / Nom / Max	kW	0.4 / 1.6 / 2.7	0.4 / 2.0 / 3.2	0.4 / 2.3 / 3.6
	Heating	Min / Nom / Max	kW	0.6 / 1.9 / 3.0	0.6 / 2.1 / 3.5	0.6 / 2.3 / 3.7
Running Current	Cooling	Min / Nom / Max	A	1.9 / 7.4 / 12.1	1.9 / 8.9 / 14.4	1.9 / 10.2 / 16.2
	Heating	Min / Nom / Max	A	2.8 / 8.6 / 13.4	2.8 / 9.6 / 15.7	2.8 / 10.4 / 16.8
EER				4.30	4.00	3.90
COP				4.40	4.30	4.41
SEER				7.30	7.20	7.00
SCOP				4.00	4.00	4.00
Pdesign (@-10°C)			kW	7.0	7.0	7.2
Seasonal Energy Label	Cooling / Heating (A++ to E Scale)			A++ / A+	A++ / A+	A++ / A+
Annual Energy Consumption	Cooling / Heating			337 / 2,450	385 / 2,450	440 / 2,520
Airflow Rate	Nom		m ³ /min	60	60	60
Sound Pressure	Cooling	Nom	dBA	49	50	50
	Heating	Nom	dBA	53	54	54
Sound Power	Cooling	Max	dBA	64	65	66
Dimensions	W x H x D		mm	950 x 834 x 330	950 x 834 x 330	950 x 834 x 330
Net Weight			Kg	61	61	61
Refrigerant	Type			R410A	R410A	R410A
	Charge		Kg	2.8	2.8	3.2
	Additional Charge		g/m	20	20	20
	GWP			2,087.5	2,087.5	2,087.5
	t-CO ₂ eq			5.8	5.8	6.7
Operation Range (Outdoor)	Cooling	Min - Max	°C DB	-10 - 48	-10 - 48	-10 - 48
	Heating	Min - Max	°C WB	-18 - 18	-18 - 18	-18 - 18
Power Supply			Ø / V / Hz	1 / 220-240 / 50	1 / 220-240 / 50	1 / 220-240 / 50
Power Supply Cable			No. x mm ²	3C x 2.5	3C x 2.5	3C x 2.5
Transmission Cable			No. x mm ²	4C x 0.75	4C x 0.75	4C x 0.75
Circuit Breaker			A	25	25	25
Piping Length Total			m	70	70	75
Piping Length per Branch	Max		m	25	25	25
Piping Elevation Difference	IDU - ODU	Max	m	15	15	15
	IDU - IDU	Max	m	7.5	7.5	7.5
Piping Connection	Liquid		mm(inch) x No.	Ø6.35 (1/4) x 4	Ø6.35 (1/4) x 4	Ø6.35 (1/4) x 5
	Gas		mm(inch) x No.	Ø9.52 (3/8) x 4	Ø9.52 (3/8) x 4	Ø9.52 (3/8) x 5

Notes :1. Capacities are based on the following conditions
Heating: - Indoor Temperature 20°C(68°F) DB/15°C(59°F) WB
- Outdoor Temperature 7°C(44.6°F) DB/6°C(42.8°F) WB
Piping Length: - Interconnecting Piping Length 7.5m
- Level Difference of Zero
2. *: See page "Combination Table".
3. Due to our policy of innovation some specifications may be changed without notification.
4. At least two indoor units should be connected
5. Minimum combination capacity rate should be more than 40%
6. This product contains fluorinated greenhouse gases (R410A)

OUTDOOR UNITS

MU5M40



LG participates in the ECP programme for EUROVENT AC program.
Check ongoing validity of certification
: www.eurovent-certification.com

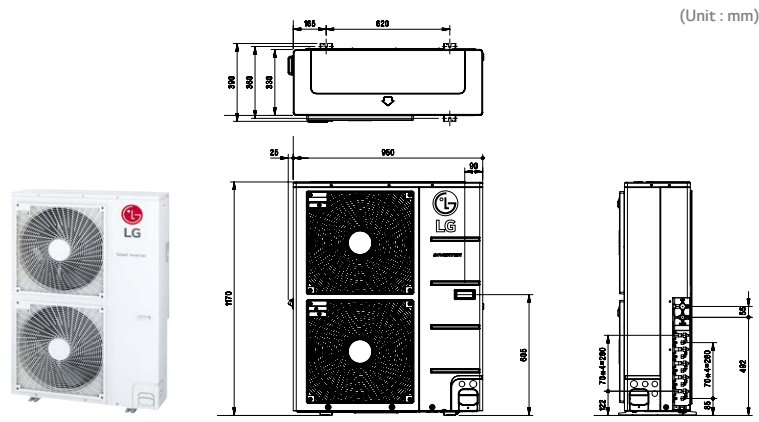

OUTDOOR				MU5M40 UO2
Compressor	Type			Twin Rotary
Capacity*	Cooling	Min / Nom / Max	kW	0.9 / 11.2 / 13.5
	Heating	Min / Nom / Max	kW	1.0 / 12.5 / 15.0
Low Temperature Capacity	Heating -7°C	Max	kW	11.0
Power Input*	Cooling	Min / Nom / Max	kW	0.8 / 2.7 / 4.2
	Heating	Min / Nom / Max	kW	0.8 / 2.8 / 4.5
Running Current	Cooling	Min / Nom / Max	A	3.5 / 12.1 / 18.4
	Heating	Min / Nom / Max	A	3.6 / 12.5 / 19.7
EER				4.10
COP				4.45
SEER				5.80
SCOP				3.81
Pdesign (@ -10°C)				11.8
Seasonal Energy Label	Cooling / Heating (A++ to E Scale)			A+ / A
Annual Energy Consumption	Cooling / Heating		kWh	643 / 4,236
Airflow Rate		Nom	m ³ /min	90
Sound Pressure	Cooling	Nom	dBA	53
	Heating	Nom	dBA	55
Sound Power	Cooling	Max	dBA	67
Dimensions	W x H x D		mm	950 x 1,170 x 330
Net Weight				84.0
Refrigerant	Type			R410A
	Charge			3.8
	Additional Charge			20
	GWP			2,087.5
	t-CO ₂ eq			7.9
Operation Range (Outdoor)	Cooling	Min - Max	°C DB	-10 - 48
	Heating	Min - Max	°C WB	-18 - 18
Power Supply				Ø / V / Hz
Power Supply Cable				No. x mm ²
Transmission Cable				No. x mm ²
Circuit Breaker				A
Piping Length Total				m
Piping Length per Branch	Max		m	25
Piping Elevation Difference	IDU - ODU	Max	m	15
	IDU - IDU	Max	m	7.5
Piping Connection	Liquid	mm (inch) x No.		Ø6.35 (1/4) x 5
	Gas	mm (inch) x No.		Ø9.52 (3/8) x 5

Note : 1. Capacities are based on the following conditions:
Cooling : - Indoor Temperature 27°C (80.6°F) DB / 19°C (66.2°F) WB - Outdoor Temperature 35°C (95°F) DB / 24°C (75.2°F) WB
Heating : - Indoor Temperature 20°C (68°F) DB / 15°C (59°F) WB - Outdoor Temperature 7°C (44.6°F) DB / 6°C (42.8°F) WB
Piping Length - Interconnecting Piping Length 7.5m - Level Difference of Zero.
2. * : See page "Combination Table".
3. Due to our policy of innovation some specifications may be changed without notification.
4. At least two indoor units should be connected.
5. Minimum combination capacity rate should be more than 40%.
6. This product contains fluorinated greenhouse gases (R410A)

FM40AH



LG participates in the ECP programme for EUROVENT AC program.
Check ongoing validity of certification
: www.eurovent-certification.com

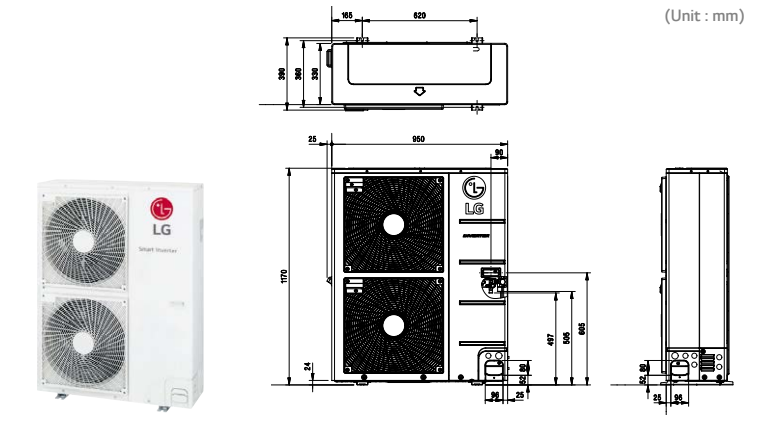

OUTDOOR				FM40AH UO2
Compressor	Type			Twin Rotary
Capacity*	Cooling	Min / Nom / Max	kW	2.8 / 11.2 / 13.5
	Heating	Min / Nom / Max	kW	3.1 / 12.5 / 15.0
Low Temperature Capacity	Heating -7°C	Max	kW	11.0
Power Input*	Cooling	Min / Nom / Max	kW	0.8 / 2.7 / 4.2
	Heating	Min / Nom / Max	kW	0.8 / 2.8 / 4.5
Running Current	Cooling	Min / Nom / Max	A	3.5 / 12.1 / 18.4
	Heating	Min / Nom / Max	A	3.6 / 12.5 / 19.7
EER				4.10
COP				4.45
SEER				5.60
SCOP				3.81
Pdesign (@ -10°C)				11.8
Seasonal Energy Label	Cooling / Heating (A++ to E Scale)			A+ / A
Annual Energy Consumption	Cooling / Heating		kWh	643 / 4,236
Airflow Rate		Nom	m ³ /min	90
Sound Pressure	Cooling	Nom	dBA	53
	Heating	Nom	dBA	55
Sound Power	Cooling	Max	dBA	67
Dimensions	W x H x D		mm	950 x 1,170 x 330
Net Weight				82.0
Refrigerant	Type			R410A
	Charge			3.8
	Additional Charge			20
	GWP			2,087.5
	t-CO ₂ eq			7.9
Operation Range (Outdoor)	Cooling	Min - Max	°C DB	-10 - 48
	Heating	Min - Max	°C WB	-18 - 18
Power Supply				Ø / V / Hz
Power Supply Cable				No. x mm ²
Transmission Cable				No. x mm ²
Circuit Breaker				A
Max Piping Length	Total Piping (Main + Total Branch)		m	100
	Main Piping		m	50
	Total Branch Piping		m	50
	Each Branch Piping		m	15
Piping Elevation Difference	IDU - ODU	Max	m	30
	IDU - IDU	Max	m	15
Piping Connection	Liquid	mm (inch)		Ø9.52 (3/8)
	Gas	mm (inch)		Ø19.05 (3/4)

Note : 1. Capacities are based on the following conditions:
Cooling : - Indoor Temperature 27°C (80.6°F) DB / 19°C (66.2°F) WB - Outdoor Temperature 35°C (95°F) DB / 24°C (75.2°F) WB
Heating : - Indoor Temperature 20°C (68°F) DB / 15°C (59°F) WB - Outdoor Temperature 7°C (44.6°F) DB / 6°C (42.8°F) WB
Piping Length - Interconnecting Piping Length 7.5m - Level Difference of Zero.
2. * : See page "Combination Table".
3. Due to our policy of innovation some specifications may be changed without notification.
4. At least two indoor units should be connected.
5. Minimum combination capacity rate should be more than 40%.
6. This product contains fluorinated greenhouse gases (R410A)

OUTDOOR UNITS

**FM48AH
FM56AH**

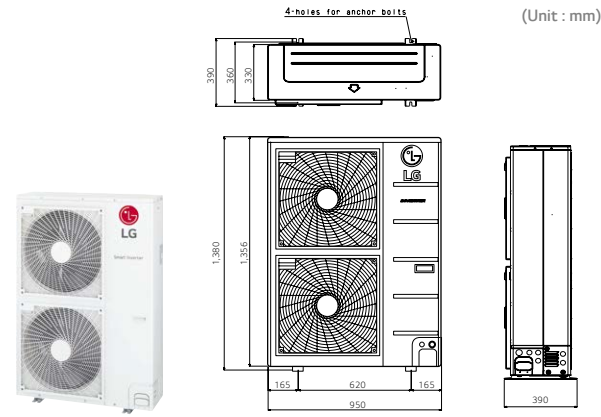

**FM41AH
FM49AH
FM57AH**

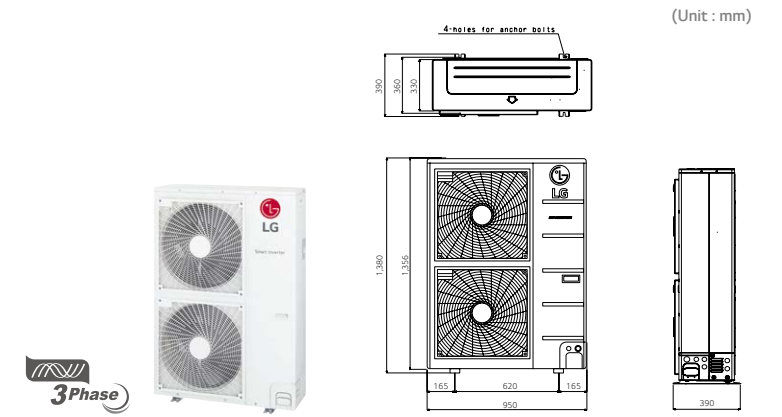

OUTDOOR				FM48AH U32	FM56AH U32	
Compressor	Type			Twin Rotary	Twin Rotary	
	Cooling	Min / Nom / Max	kW	3.3 / 14.0 / 17.0	4.0 / 15.5 / 18.5	
Capacity*	Heating	Min / Nom / Max	kW	3.7 / 16.0 / 17.3	4.5 / 17.4 / 18.8	
	Low Temperature Capacity	Heating -7°C	Max	14.8	16.1	
Power Input*	Cooling	Min / Nom / Max	kW	0.8 / 3.2 / 5.1	1.0 / 3.9 / 5.9	
	Heating	Min / Nom / Max	kW	1.3 / 3.7 / 5.2	1.5 / 4.2 / 6.2	
Running Current	Cooling	Min / Nom / Max	A	3.9 / 13.2 / 22.3	4.6 / 16.1 / 25.7	
	Heating	Min / Nom / Max	A	6.9 / 15.6 / 22.7	7.4 / 16.8 / 27.2	
EER			4.41	4.01		
COP			4.37	4.18		
SEER			6.1	5.6		
SCOP			4.0	4.0		
Pdesign (@ -10°C)			kW	11.7	12.3	
Seasonal Energy Label	Cooling / Heating (A++ to E Scale)		-			
Annual Energy Consumption	Cooling / Heating		kWh	1,377 / 4,095	1,661 / 4,305	
Airflow Rate	Nom		m ³ /min	120	120	
	Cooling	Nom	dBA	54	54	
Sound Pressure	Nom		dBA	56	56	
	Heating	Nom	dBA	56	56	
Sound Power	Cooling / Heating Max		dBA	68 / 71	69 / 73	
Dimensions	W x H x D		mm	950 x 1,380 x 330	950 x 1,380 x 330	
Net Weight			kg	96.0	96.0	
Refrigerant	Type			R410A	R410A	
	Charge			kg	4.4	4.4
	Additional Charge			g/m	20	20
	GWP				2,087.5	2,087.5
	t-CO ₂ eq				9.2	9.2
Operation Range (Outdoor)	Cooling	Min - Max	°C DB	-10 - 48	-10 - 48	
	Heating	Min - Max	°C WB	-18 - 18	-18 - 18	
Power Supply			Ø / V / Hz	1 / 220-240 / 50	1 / 220-240 / 50	
Power Supply Cable			No. x mm ²	3C x 4.0	3C x 4.0	
Transmission Cable	ODU-BD			No. x mm ²	4C x 1.25	4C x 1.25
	BD-IDU			No. x mm ²	4C x 0.75	4C x 0.75
Circuit Breaker			A	40	40	
Max Piping Length	Total Piping (Main + Total Branch)		m	135	145	
	Main Piping		m	55	55	
	Total Branch Piping		m	80	90	
	Each Branch Piping		m	15	15	
Piping Elevation Difference	IDU - ODU	Max	m	30	30	
	IDU - IDU	Max	m	15	15	
Piping Connection	Liquid			mm (inch)	Ø9.52 (3/8)	Ø9.52 (3/8)
	Gas			mm (inch)	Ø19.05 (3/4)	Ø19.05 (3/4)

Note : 1. Capacities are based on the following conditions:
 Cooling : - Indoor Temperature 27°C (80.6°F) DB / 19°C (66.2°F) WB - Outdoor Temperature 35°C (95°F) DB / 24°C (75.2°F) WB
 Heating : - Indoor Temperature 20°C (68°F) DB / 15°C (59°F) WB - Outdoor Temperature 7°C (44.6°F) DB / 6°C (42.8°F) WB
 Piping Length - Interconnecting Piping Length 7.5m - Level Difference of Zero.
 2. *: See page "Combination Table".
 3. Due to our policy of innovation some specifications may be changed without notification.
 4. At least two indoor units should be connected.
 5. Minimum combination capacity rate should be more than 40%.
 6. This product contains fluorinated greenhouse gases (R410A)

OUTDOOR				FM41AH U32	FM49AH U32	FM57AH U32
Compressor	Type			Twin Rotary	Twin Rotary	Twin Rotary
	Cooling	Min / Nom / Max	kW	2.8 / 12.1 / 14.1	3.3 / 14.0 / 17.0	4.0 / 15.5 / 18.5
Capacity*	Heating	Min / Nom / Max	kW	3.2 / 12.5 / 15.2	3.7 / 16.0 / 17.3	4.5 / 17.4 / 18.8
	Low Temperature Capacity	Heating -7°C	Max	11.1	13.6	15.2
Power Input*	Cooling	Min / Nom / Max	kW	0.8 / 2.4 / 3.8	0.8 / 3.2 / 5.1	1.0 / 3.9 / 5.9
	Heating	Min / Nom / Max	kW	0.9 / 2.5 / 4.7	1.3 / 3.7 / 5.2	1.5 / 4.2 / 6.2
Running Current	Cooling	Min / Nom / Max	A	1.5 / 3.3 / 5.7	1.8 / 4.4 / 7.3	2.3 / 5.4 / 8.4
	Heating	Min / Nom / Max	A	1.7 / 3.3 / 6.9	2.1 / 5.1 / 7.5	2.5 / 5.5 / 9.0
EER			4.68	4.41	4.01	
COP			4.92	4.37	4.18	
SEER			6.1	6.1	5.6	
SCOP			4.0	4.0	4.0	
Pdesign (@ -10°C)			kW	11.7	11.7	12.3
Seasonal Energy Label	Cooling / Heating (A++ to E Scale)		-			
Annual Energy Consumption	Cooling / Heating		kWh	1,190 / 4,095	1,377 / 4,095	1,661 / 4,305
Airflow Rate	Nom		m ³ /min	120	120	120
	Cooling	Nom	dBA	53	54	54
Sound Pressure	Nom		dBA	55	56	56
	Heating	Nom	dBA	55	56	56
Sound Power	Cooling / Heating Max		dBA	67 / 69	68 / 71	69 / 73
Dimensions	W x H x D		mm	950 x 1,380 x 330	950 x 1,380 x 330	950 x 1,380 x 330
Net Weight			kg	96.0	96.0	96.0
Refrigerant	Type			R410A	R410A	R410A
	Charge			kg	4.4	4.4
	Additional Charge			g/m	20	20
	GWP				2,087.5	2,087.5
	t-CO ₂ eq				9.2	9.2
Operation Range (Outdoor)	Cooling	Min - Max	°C DB	-10 - 48	-10 - 48	-10 - 48
	Heating	Min - Max	°C WB	-18 - 18	-18 - 18	-18 - 18
Power Supply			Ø / V / Hz	3 / 380-415 / 50	3 / 380-415 / 50	3 / 380-415 / 50
Power Supply Cable			No. x mm ²	5C x 2.5	5C x 2.5	5C x 2.5
Transmission Cable	ODU-BD			No. x mm ²	4C x 1.25	4C x 1.25
	BD-IDU			No. x mm ²	4C x 0.75	4C x 0.75
Circuit Breaker			A	20	20	
Max Piping Length	Total Piping (Main + Total Branch)		m	125	135	145
	Main Piping		m	55	55	
	Total Branch Piping		m	70	80	
	Each Branch Piping		m	15	15	
Piping Elevation Difference	IDU - ODU	Max	m	30	30	
	IDU - IDU	Max	m	15	15	
Piping Connection	Liquid			mm (inch)	Ø9.52 (3/8)	Ø9.52 (3/8)
	Gas			mm (inch)	Ø19.05 (3/4)	Ø19.05 (3/4)

Note : 1. Capacities are based on the following conditions:
 Cooling : - Indoor Temperature 27°C (80.6°F) DB / 19°C (66.2°F) WB - Outdoor Temperature 35°C (95°F) DB / 24°C (75.2°F) WB
 Heating : - Indoor Temperature 20°C (68°F) DB / 15°C (59°F) WB - Outdoor Temperature 7°C (44.6°F) DB / 6°C (42.8°F) WB
 Piping Length - Interconnecting Piping Length 7.5m - Level Difference of Zero.
 2. *: See page "Combination Table".
 3. Due to our policy of innovation some specifications may be changed without notification.
 4. At least two indoor units should be connected.
 5. Minimum combination capacity rate should be more than 40%.
 6. This product contains fluorinated greenhouse gases (R410A)

WALL MOUNTED UNITS

Wi-Fi Control

Control your air conditioners via using the smart internet devices as Android or iOS based smartphones. This advanced technology provides you the best convenience.

• LG Smart ThinQ



Search "LG Smart ThinQ" on Google market or Appstore then download the app.



LG Smart ThinQ

• How it Works

Easy Registration and Log-in

Follow the easy set-up steps that will activate SmartThinQ's impressive feature.

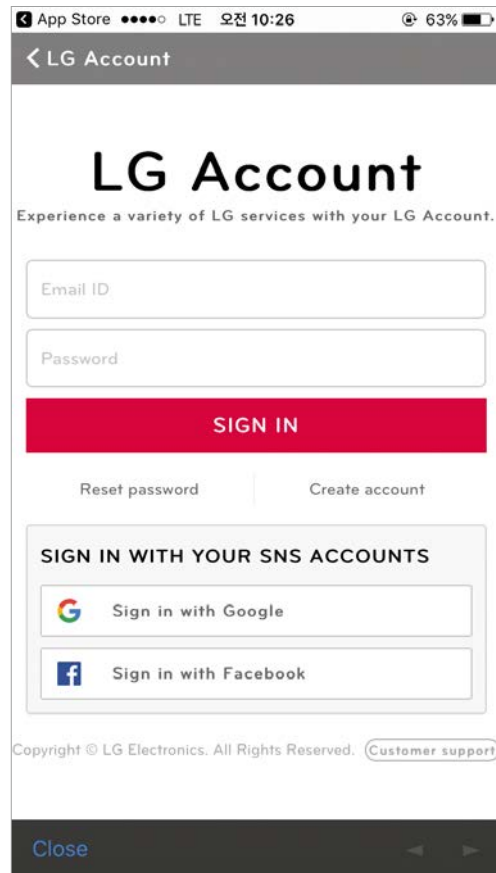

• Wi-Fi Connectivity

Let's every member of your family choose their own preferred air conditioning temperature and fan speed, then save the settings in their app to run later. You can save the setting for each air conditioner as well.

Multiple Devices



Multi-Control



* Can be controlled by multiple users, but not simultaneously

Aesthetic Design

You no longer need to be told what your air conditioner should look like. With LG's revolutionary ARTCOOL Gallery, you can change the look of your air conditioner to whatever you want, whenever you want. The ARTCOOL series have outstanding designs and have been awarded the International Forum Design Award, the Reddot Design Award and the G Mark.

• Gallery



• How to Change the Picture

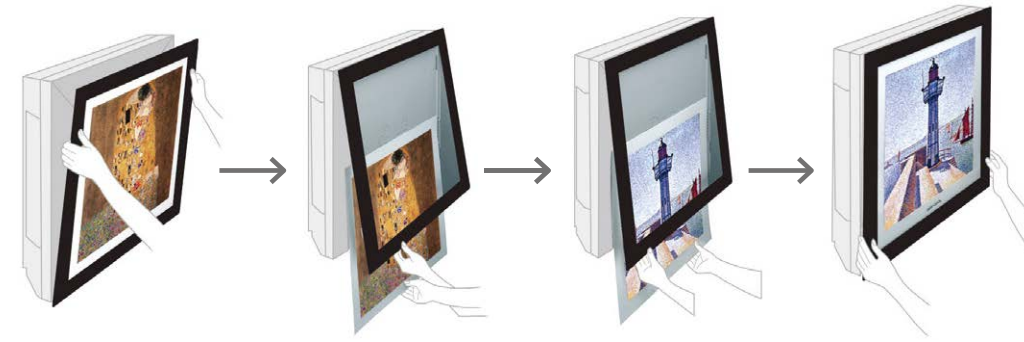

• ARTCOOL



• Deluxe



• Standard Plus



WALL MOUNTED UNITS

Plasmaster™ Ionizer^{PLUS}

The powerful plasma ionizer protects you from odors and harmful substances in the air with over 3 million ions to sterilize not only the air passing through the air conditioner, but also surrounding surfaces for a safer, cleaner environment.

* Specifications may vary for each model.
 * Depending on the experimental conditions.
 * This function will be available with following models and date.
 - ARNU**GSJN4, ARNU**GSKN4 : From ` 17 May

• How It Works

Sterilization and Deodorization (Utilizes Over 3 Million Ions)

Plasmaster Ionizer+ reduces harmful microscopic particles by infusing the air passing through the air conditioner with over 3 millions ions.

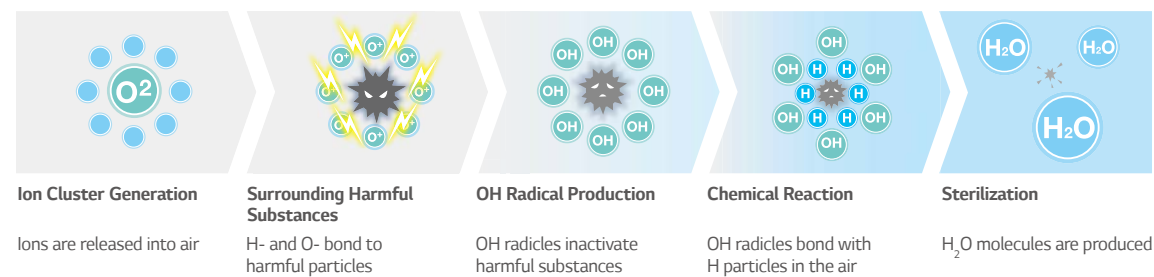

• Test Result

Sterilization Performance Evaluations

Plasmaster Ionizer+ reduces harmful microscopic particles by infusing the air passing through the air conditioner with over 3 millions ions.

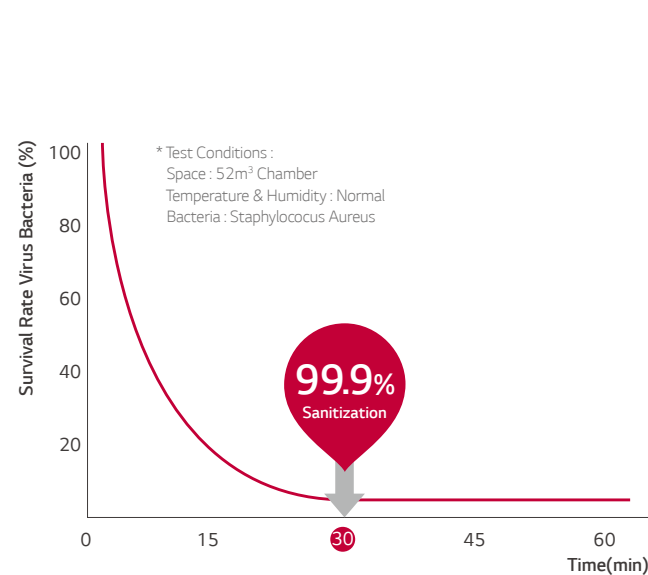

2.1 odor strength decrease in 60 minutes

An odor of strength 2 or less indicates that there is odor but no sense of displeasure (degree of odor permissible).

Odor Strength	1	2	3	4
Offensive odor substance sensitivity				
	Mountain smell	Indoor life smell	Bathroom smell	Food waste smell
Odor strength level	Light	Moderate	Strong	Very Strong

← 1.5 Plasmaster Ionizer^{PLUS} 3.6 →

Odor strength reduce 3.6 → 1.5 / The Odor floating in the room as well as curtain and clothes.

Quick & Easy Installation

LG air conditioner is designed for an easy and efficient installation, making possible to install several units in a short period of time

* Specifications may vary for each model.

• Concept

By reducing the manpower and time required for installation, it is now possible to install more units in less time.

• How It Works

One Simple Packing Box

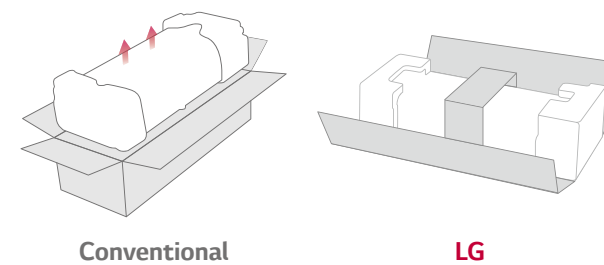

Conventional

LG

Installation Plate Improvement

LG's installation plate is larger and customized to reduce installation time.

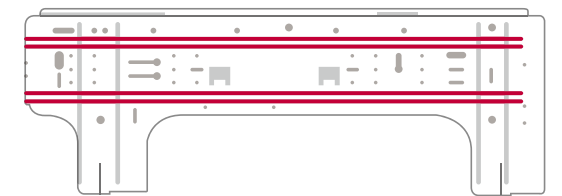

Installation Support Clip

A support clip creates adequate space between the wall and the unit for easier installation.

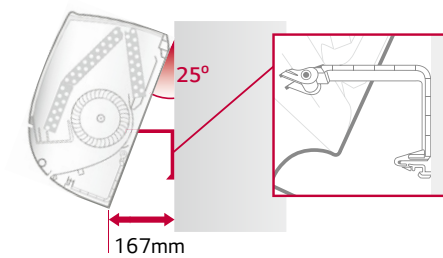

Wider Tubing Space

The space provided for tubing facilitates the whole installation process and hides the unorganized parts, making it appear clean and tidy.

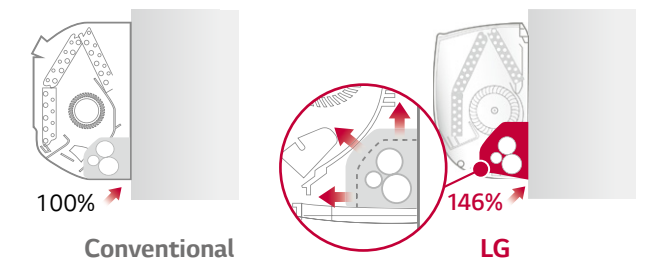

Conventional

LG

Detachable Bottom Cover

The air conditioner's bottom cover is detachable for easier installation and access.

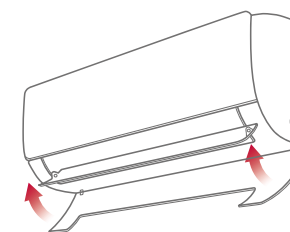

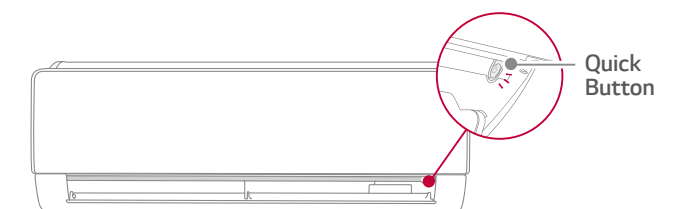

Quick button for running test

The test button is conveniently located and easy to find.



Quick Button

WALL MOUNTED UNITS



		kBtu/h	5	7	9	12	15	18	24
		kW	1.5	2.1	2.6	3.5	4.2	5.3	7.0
Wall Mounted Unit	ARTCOOL Gallery 	-	-	MA09AH1	MA12AH1	-	-	-	-
	ARTCOOL 	-	AM07BP	AM09BP	AM12BP	-	AM18BP	AM24BP	-

ARTCOOL Gallery

		MA09AH1.NF1		MA12AH1.NF1	
Capacity	Cooling / Heating	Nom	kW	2.6 / 2.9	3.5 / 3.9
Power Input			W x No.	40 x 1	40 x 1
Running Current			A	0.1	0.1
Power Supply			Ø / V / Hz	1 / 220-240 / 50	1 / 220-240 / 50
Air Flow Rate		H / M / L	m ³ /min	7.7 / 5.9 / 4.4	8.9 / 7.3 / 5.6
Sound Pressure		H / M / L	dB(A)	38 / 32 / 27	44 / 38 / 32
Sound Power		Cooling	dB(A)	52	54
Dehumidification Rate			l/h	1.2	1.4
Dimensions	Body	W x H x D	mm	600 x 600 x 145	600 x 600 x 145
Net Weight	Body		kg	15.0	15.0
Piping	Liquid		mm(inch)	Ø 6.35 (1/4)	Ø 6.35 (1/4)
Connections	Gas		mm(inch)	Ø 9.52 (3/8)	Ø 9.52 (3/8)

ARTCOOL

		AM07BP NSJ	AM09BP NSJ	AM12BP NSJ	AM18BP NSK	AM24BP NSK		
Capacity	Cooling / Heating	Nom	kW	2.1 / 2.3	2.5 / 3.2	3.5 / 3.8	5.0 / 5.8	6.6 / 7.5
Power Input			W	17	18	19	39	45
Running Current			A	0.14	0.16	0.17	0.28	0.33
Power Supply			Ø / V / Hz	1 / 220-240 / 50	1 / 220-240 / 50	1 / 220-240 / 50	1 / 220-240 / 50	1 / 220-240 / 50
Air Flow Rate		H / M / L	m ³ /min	8.6 / 7.2 / 5.6	9.2 / 7.4 / 5.6	9.6 / 8.1 / 5.6	14.2 / 11.3 / 9.9	15.2 / 12.7 / 10.2
Sound Pressure		H / M / L	dB(A)	35 / 32 / 27	36 / 33 / 27	40 / 35 / 27	44 / 38 / 35	46 / 41 / 36
Sound Power			dB(A)	57	57	57	59	65
Dehumidification Rate			l/h	0.9	1.1	1.2	1.9	2.6
Dimension		W x H x D	mm	837 x 308 x 192	837 x 308 x 192	837 x 308 x 192	998 x 345 x 212	998 x 345 x 212
Net weight			kg	9.1	9.9	9.9	13.2	11.6
Piping	Liquid		mm (inch)	Ø 6.35 (1/4)	Ø 6.35 (1/4)	Ø 6.35 (1/4)	Ø 6.35 (1/4)	Ø 6.35 (1/4)
Connection	Gas		mm (inch)	Ø 9.52 (3/8)	Ø 9.52 (3/8)	Ø 9.52 (3/8)	Ø 12.7 (1/2)	Ø 12.7 (1/2)

		kBtu/h	5	7	9	12	15	18	24
		kW	1.5	2.1	2.6	3.5	4.2	5.3	7.0
Wall Mounted Unit	Deluxe 	-	-	DM07RP	DM09RP	DM12RP	-	DM18RP	DM24RP
	Standard Plus 	-	PM05SP	PM07SP	PM09SP	PM12SP	PM15SP	PM18SP	PM24SP

DELUXE

		DM07RP.NSJ	DM09RP.NSJ	DM12RP.NSJ	DM18RP.NSK	DM24RP.NSK		
Capacity	Cooling / Heating	Nom	kW	2.1 / 2.3	2.5 / 3.2	3.5 / 4.0	5.0 / 5.8	6.6 / 7.5
Power Input			W	17	18	19	39	45
Running Current			A	0.15	0.16	0.17	0.28	0.33
Power Supply			Ø / V / Hz	1 / 220-240 / 50	1 / 220-240 / 50	1 / 220-240 / 50	1 / 220-240 / 50	1 / 220-240 / 50
Air Flow Rate		H / M / L	m ³ /min	7.5 / 6.1 / 4.9	7.7 / 6.4 / 5.0	8.1 / 6.7 / 5.3	14.2 / 11.3 / 9.9	15.2 / 12.7 / 10.2
Sound Pressure		H / M / L	dB(A)	35 / 31 / 26	36 / 32 / 27	38 / 34 / 29	44 / 38 / 34	47 / 41 / 36
Sound Power			dB(A)	56	56	56	60	64
Dehumidification Rate			l/h	0.9	1.1	1.2	1.9	2.6
Dimension		W x H x D	mm	837 x 308 x 189	837 x 308 x 189	837 x 308 x 189	998 x 345 x 210	998 x 345 x 210
Net weight			kg	8.3	8.3	8.3	12.0	12.0
Piping	Liquid		mm (inch)	Ø 6.35 (1/4)	Ø 6.35 (1/4)	Ø 6.35 (1/4)	Ø 6.35 (1/4)	Ø 6.35 (1/4)
Connection	Gas		mm (inch)	Ø 9.52 (3/8)	Ø 9.52 (3/8)	Ø 9.52 (3/8)	Ø 12.7 (1/2)	Ø 12.7 (1/2)

STANDARD PLUS

		PM05SP.NSJ	PM07SP.NSJ	PM09SP.NSJ	PM12SP.NSJ	PM15SP.NSJ	PM18SP.NSK	PM24SP.NSK		
Capacity	Cooling / Heating	Nom	kW	1.5 / 1.6	2.1 / 2.3	2.5 / 3.2	3.5 / 3.8	4.2 / 5.4	5.0 / 5.8	6.6 / 7.5
Power Input			W	16	17	18	19	21	39	45
Running Current			A	0.13	0.14	0.16	0.17	0.18	0.28	0.33
Power Supply			Ø / V / Hz	1 / 220-240 / 50	1 / 220-240 / 50	1 / 220-240 / 50	1 / 220-240 / 50	1 / 220-240 / 50	1 / 220-240 / 50	1 / 220-240 / 50
Air Flow Rate		H / M / L	m ³ /min	8.3 / 6.7 / 5.6	8.6 / 7.2 / 5.6	9.2 / 7.4 / 5.6	9.6 / 8.1 / 5.6	10.0 / 8.5 / 6.1	14.2 / 11.3 / 9.9	15.2 / 12.7 / 10.2
Sound Pressure		H / M / L	dB(A)	34 / 31 / 27	35 / 32 / 27	36 / 33 / 27	40 / 35 / 27	41 / 36 / 29	44 / 38 / 35	46 / 41 / 36
Sound Power			dB(A)	57	57	57	57	57	59	65
Dehumidification Rate			l/h	0.9	0.9	1.1	1.2	1.2	1.9	2.6
Dimension		W x H x D	mm	837 x 308 x 189	837 x 308 x 189	837 x 308 x 189	837 x 308 x 189	837 x 308 x 189	998 x 345 x 210	998 x 345 x 210
Net weight			kg	8.7	8.7	8.7	8.7	8.7	12.0	12.8
Piping	Liquid		mm (inch)	Ø 6.35 (1/4)	Ø 6.35 (1/4)	Ø 6.35 (1/4)	Ø 6.35 (1/4)	Ø 6.35 (1/4)	Ø 6.35 (1/4)	Ø 6.35 (1/4)
Connection	Gas		mm (inch)	Ø 9.52 (3/8)	Ø 9.52 (3/8)	Ø 9.52 (3/8)	Ø 9.52 (3/8)	Ø 9.52 (3/8)	Ø 12.7 (1/2)	Ø 12.7 (1/2)

CEILING MOUNTED CASSETTE

950/700 Panel – Wide Jet Air Flow

Improved vanes reduce the curved area and provide even distribution.

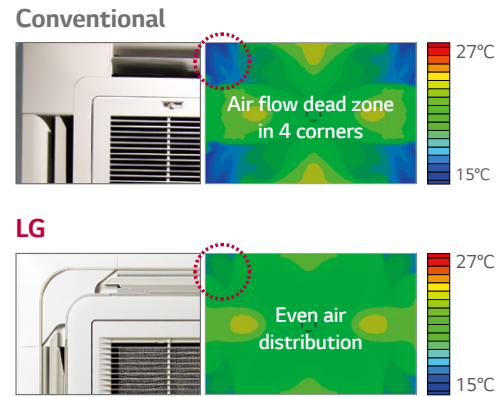
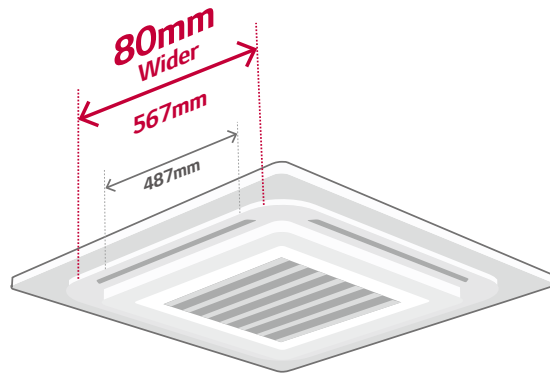

620 Panel – Compact and Stylish Design

- New 4 way cassette panel adapted unibody shape and matching with into the ceiling
- Panel size is fit into the ceiling tile

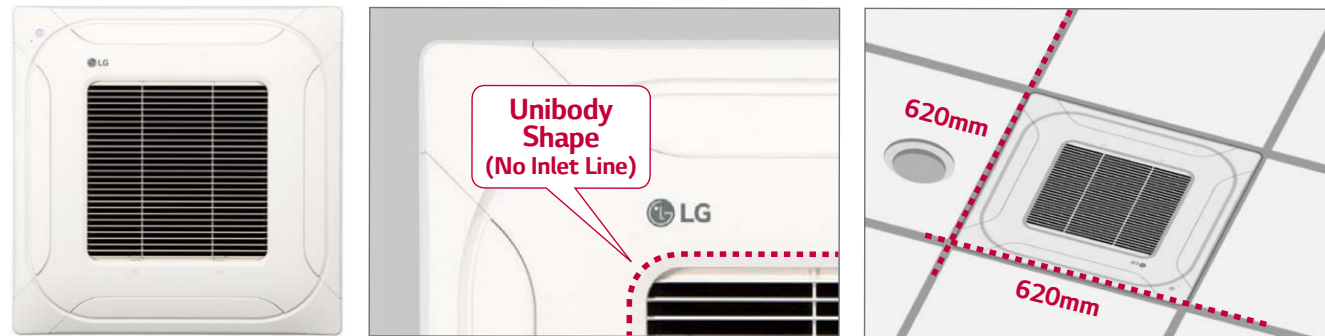

Convenient Panel Installation

The detachable corner design makes it easy to adjust the hanger during installation and to check for leakages in the drain connection pipe.

Detachable Corner Design

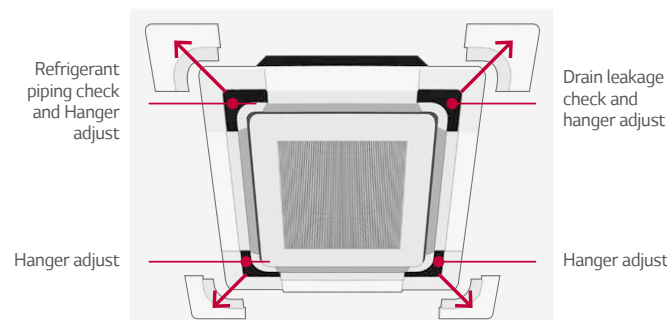

Drain Leakage Check

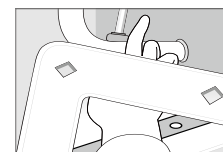

Hanger Adjust

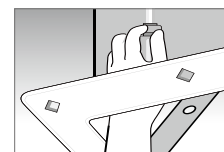

It is easy to install the panel to the body, using the button type panel design.

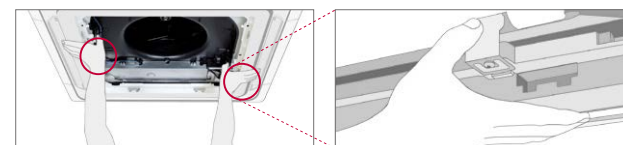

		CAPACITY (kW)		1.5	2.1	2.6	3.5	5.3	7.0
1 Way Cassette			-	-	MT09AH NU1	MT11AH NU1	-	-	-
4 Way Cassette			MT06AH NR0	MT08AH NR0	CT09 NR2	CT12 NR2	CT18 NQ4	CT24 NP4	

INDOOR				MT09AH NU1	MT11AH NU1	MT06AH NR0	MT08AH NR0
Capacity	Cooling / Heating	Nom	kW	2.6 / 2.9	3.5 / 3.9	1.5 / 1.6	2.1 / 2.3
Power Input		Nom	W	20	20	20	20
Running Current		Nom	A	0.2	0.2	0.4	0.4
Power Supply			Ø / V / Hz	1 / 220-240 / 50	1 / 220-240 / 50	1 / 220-240 / 50	1 / 220-240 / 50
Air Flow Rate		H / M / L	m ³ /min	7.5 / 7.3 / 6.8	8.1 / 7.4 / 7.0	7.5 / 6.0 / 5.0	7.5 / 6.0 / 5.0
Sound Pressure	Cooling	H / M / L	dBA	36 / 34 / 32	37 / 36 / 33	31 / 27 / 24	31 / 27 / 24
Sound Power	Cooling	Max	dBA	54	57	48	48
Dehumidification Rate			l/h	1.1	1.2	0.8	1
Dimensions	Body	W x H x D	mm	860 x 132 x 450	860 x 132 x 450	570 x 214 x 570	570 x 214 x 570
Net Weight	Body		kg	13.5	13.5	14.0	14.0
Piping	Liquid		mm (inch)	Ø6.35 (1/4)	Ø6.35 (1/4)	Ø6.35 (1/4)	Ø6.35 (1/4)
Connection	Gas		mm (inch)	Ø9.52 (3/8)	Ø9.52 (3/8)	Ø9.52 (3/8)	Ø9.52 (3/8)
Decoration Panel	Model			PT-UUC1	PT-UUC1	PT-UQC, PT-QCHW0	
	Color			Morning Fog (RAL120-4)	Morning Fog (RAL120-4)	Morning Fog (RAL 120-4)	
	Dimensions	W x H x D	mm	1,100 x 34 x 500	1,100 x 34 x 500	700 x 22 x 700, 620 x 20 x 620	
	Weight		kg	4.4	4.4	3.0	

* CT09, CT12, CT18, CT24 are compatible between SCAC and MULTI.

INDOOR				CT09 NR2	CT12 NR2	CT18 NQ4	CT24 NP4
Capacity	Cooling / Heating	Nom	kW	2.6 / 2.9	3.5 / 3.9	5.3 / 5.8	6.7 / 7.5
Power Input		Nom	W	20	20	20	20
Running Current		Nom	A	0.4	0.4	0.4	0.6
Power Supply			Ø / V / Hz	1 / 220-240 / 50	1 / 220-240 / 50	1 / 220-240 / 50	1 / 220-240 / 50
Air Flow Rate		H / M / L	m ³ /min	8.5 / 7.0 / 6.0	9.5 / 8.0 / 7.0	13.0 / 12.0 / 11.0	17.0 / 15.0 / 13.0
Sound Pressure	Cooling	H / M / L	dBA	36 / 33 / 30	38 / 35 / 32	41 / 39 / 36	38 / 36 / 34
Sound Power	Cooling	Max	dBA	48	51	55	57
Dehumidification Rate			l/h	1.4	1.7	2.1	2.4
Dimensions	Body	W x H x D	mm	570 x 214 x 570	570 x 214 x 570	570 x 256 x 570	840 x 204 x 840
Net Weight	Body		kg	14.0	14.0	15.5	20.5
Piping	Liquid		mm (inch)	Ø6.35 (1/4)	Ø6.35 (1/4)	Ø6.35 (1/4)	Ø6.35 (1/4)
Connection	Gas		mm (inch)	Ø9.52 (3/8)	Ø9.52 (3/8)	Ø12.7 (1/2)	Ø12.7 (1/2)
Decoration Panel	Model				PT-UQC, PT-QCHW0		PT-UMC1
	Color				Morning Fog (RAL 120-4)		Morning Fog (120-4)
	Dimensions	W x H x D	mm		700 x 22 x 700, 620 x 20 x 620		950 x 25 x 950
	Weight		kg		3.0		5.0

Note: 1. Capacities are based on the following conditions:
 Cooling: - Indoor Temperature 27°C (80.6°F) DB / 19°C (66.2°F) WB - Outdoor Temperature 35°C (95°F) DB / 24°C (75.2°F) WB
 Heating: - Indoor Temperature 20°C (68°F) DB / 15°C (59°F) WB - Outdoor Temperature 7°C (44.6°F) DB / 6°C (42.8°F) WB
 Piping Length - Interconnecting Piping Length 7.5m - Level Difference of Zero
 2. Definition of Power Input Nominal conditions - Performance tested under EN14511
 3. Due to our policy of innovation some specifications may be changed without notification
 4. This product contains fluorinated greenhouse gases (R410A)

CEILING CONCEALED DUCT

E.S.P. (External Static Pressure) Control

E.S.P. control function can make air volume controlled easily with remote controller. The BLDC motor can control fan speed and air volume regardless of the external static pressure. No additional accessories are necessary to control air flow.

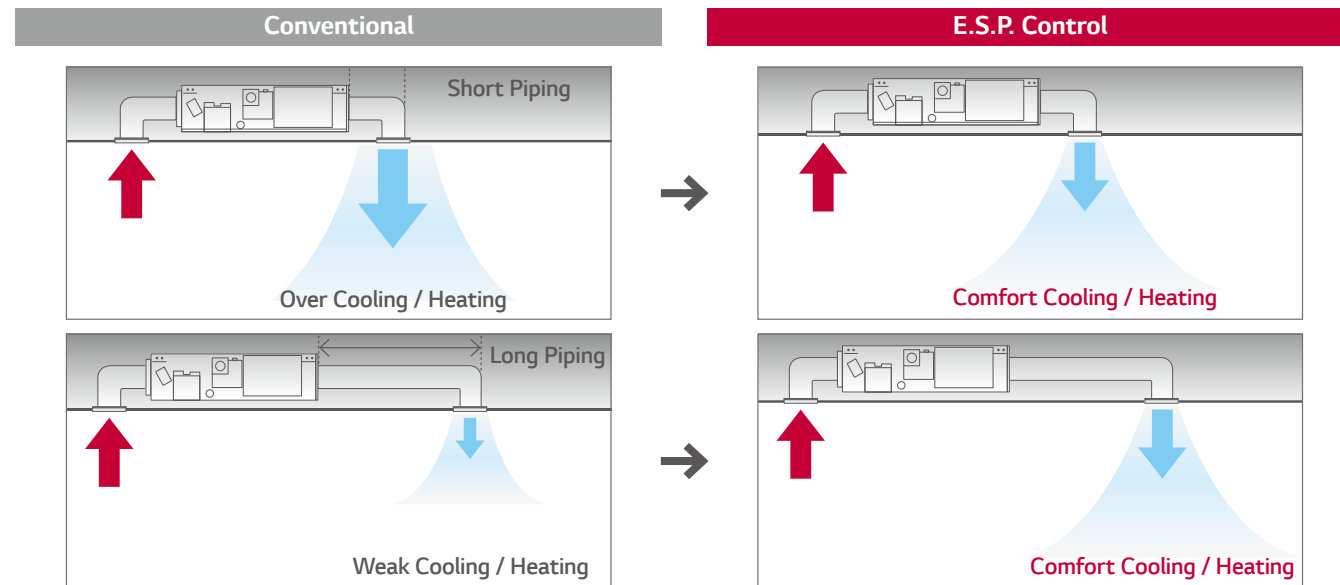

CAPACITY (KW)		2.6	3.5	5.3	7.0
Ceiling Concealed Duct		CB09L N12	CB12L N22	CB18L N22	CB24L N32
		-	-	CM18 N14	CM24 N14

INDOOR		CB09L N12	CB12L N22	CB18L N22	CB24L N32
Capacity	Cooling / Heating Nom kW	2.6 / 2.9	3.5 / 3.9	5.3 / 5.8	7.0 / 7.7
Power Input	Min / Max (Nom ESP) W	40 / 60	80 / 100	100 / 140	110 / 160
Running Current	Nom A	0.4	0.8	0.8	1.0
Power Supply	Ø / V / Hz	1 / 220-240 / 50	1 / 220-240 / 50	1 / 220-240 / 50	1 / 220-240 / 50
Air Flow Rate	H / M / L m³/min	9.0 / 7.0 / 5.5	10.0 / 8.5 / 7.0	15.0 / 12.5 / 10.0	20.0 / 16.0 / 12.0
Sound Pressure	Cooling H / M / L dBA	30 / 26 / 23	31 / 28 / 27	36 / 34 / 31	39 / 35 / 32
Sound Power	Cooling Max dBA	49	52	54	58
Dehumidification Rate	l/h	1.1	1.2	1.7	2.2
Dimensions	Body W x H x D mm	700 x 190 x 700	900 x 190 x 700	900 x 190 x 700	1,100 x 190 x 700
Net Weight	Body kg	17.5	23.0	23.0	27.0
Piping	Liquid mm (inch)	Ø6.35 (1/4)	Ø6.35 (1/4)	Ø6.35 (1/4)	Ø9.52 (3/8)
Connection	Gas mm (inch)	Ø9.52 (3/8)	Ø9.52 (3/8)	Ø12.7 (1/2)	Ø15.88 (5/8)
External Static Pressure	Min - Max mmAq (Pa)	0 - 5 (0 - 49)	0 - 5 (0 - 49)	0 - 5 (0 - 49)	0 - 5 (0 - 49)

* CB09L, CB12L, CB18L, CB24L are compatible between SCAC and MULTI.

* CM18, CM24 are compatible between SCAC and MULTI.

Easy Service & Maintenance

Users don't need to open whole panel for maintenance, since panel is divided into one for heat exchanger and one for fan/motor. Easily detach and attach the filter even in limited space.

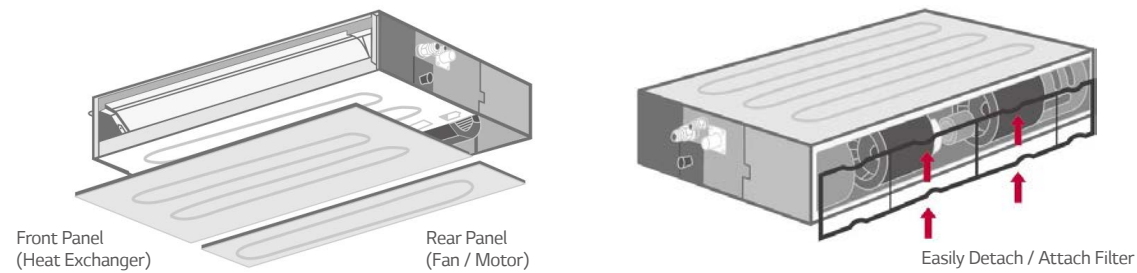

Flexible Installation

The new low static duct allows the air intake at the rear or bottom under installation condition.

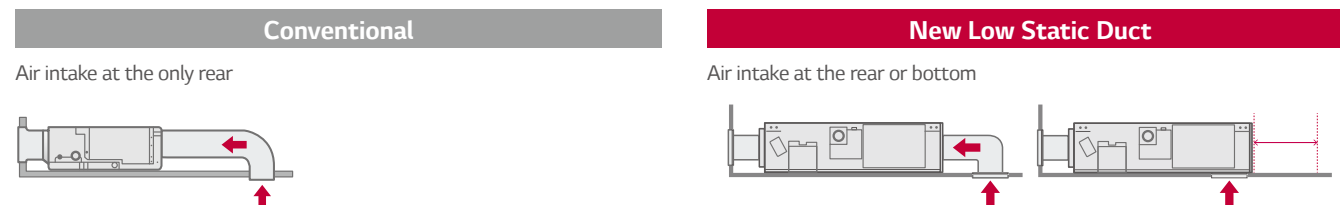

INDOOR		CM18 N14	CM24 N14
Capacity	Cooling / Heating Nom kW	5.3 / 5.8	7.0 / 7.7
Power Input	Min / Max (Nom ESP) W	90 / 160	100 / 180
Running Current	Nom A	0.9	1.0
Power Supply	Ø / V / Hz	1 / 220-240 / 50	1 / 220-240 / 50
Air Flow Rate	H / M / L m³/min	16.5 / 14.5 / 13.0	18.0 / 16.5 / 14.5
Sound Pressure	Cooling H / M / L dBA	34 / 32 / 30	35 / 34 / 32
Sound Power	Cooling Max dBA	59	60
Dehumidification Rate	l/h	2.0	2.5
Dimensions	Body W x H x D mm	900 x 270 x 700	900 x 270 x 700
Net Weight	Body kg	23.8	24.2
Piping	Liquid mm (inch)	Ø6.35 (1/4)	Ø6.35 (1/4)
Connection	Gas mm (inch)	Ø12.7 (1/2)	Ø12.7 (1/2)
External Static Pressure	Min - Max mmAq (Pa)	2.5-15 (25-147)	2.5-15 (25-147)

Note : 1. Capacities are based on the following conditions :
 Cooling : - Indoor Temperature 27°C (80.6°F) DB / 19°C (66.2°F) WB - Outdoor Temperature 35°C (95°F) DB / 24°C (75.2°F) WB
 Heating : - Indoor Temperature 20°C (68°F) DB / 15°C (59°F) WB - Outdoor Temperature 7°C (44.6°F) DB / 6°C (42.8°F) WB
 Piping Length - Interconnecting Piping Length 7.5m - Level Difference of Zero
 2. Definition of Power Input Nominal conditions - Performance tested under EN14511
 3. Due to our policy of innovation some specifications may be changed without notification
 4. This product contains fluorinated greenhouse gases (R410A)

CEILING SUSPENDED UNIT

Flexible Installation

The ceiling and floor models can be installed either on the ceiling or on the floor. This saves space when installed in the shops or offices.

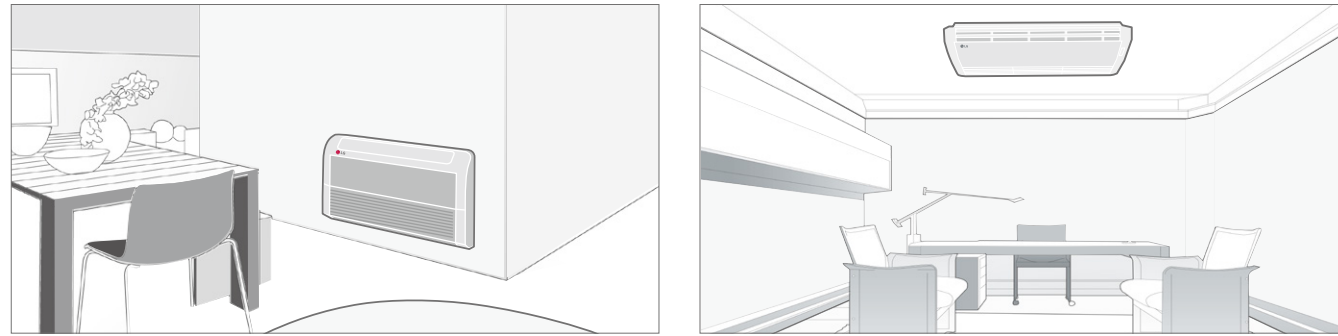

* Ceiling & Floor : CV09 NE2 / CV12 NE2

	CAPACITY (KW)	2.6	3.5	5.3	7.0
Ceiling & Floor Convertible unit		CV09 NE2	CV12 NE2	-	-
Ceiling Suspended unit		-	-	CV18 NJ2	CV24 NJ2

INDOOR				CV09 NE2	CV12 NE2
Capacity	Cooling / Heating	Nom	kW	2.6 / 2.9	3.5 / 3.9
Power Input		Nom	W	30	40
Running Current		Nom	A	0.4	0.4
Power Supply			Ø / V / Hz	1 / 220-240 / 50	1 / 220-240 / 50
Air Flow Rate		H / M / L	m ³ /min	7.6 / 6.9 / 6.2	9.2 / 7.6 / 6.6
Sound Pressure	Cooling	H / M / L	dBA	38 / 35 / 32	40 / 36 / 31
Sound Power	Cooling	Max	dBA	52	56
Dehumidification Rate			l/h	1.2	1.2
Dimensions	Body	W x H x D	mm	900 x 490 x 200	900 x 490 x 200
Net Weight	Body		kg	13.7	13.7
Piping	Liquid		mm (inch)	Ø6.35 (1/4)	Ø6.35 (1/4)
Connection	Gas		mm (inch)	Ø9.52 (3/8)	Ø9.52 (3/8)

* CV09, CV12, CV18, CV24 are compatible between SCAC and MULTI.

Airflow Direction Control

Vertical airflow direction can be adjusted using remote controller, and horizontal airflow direction can be adjusted manually.

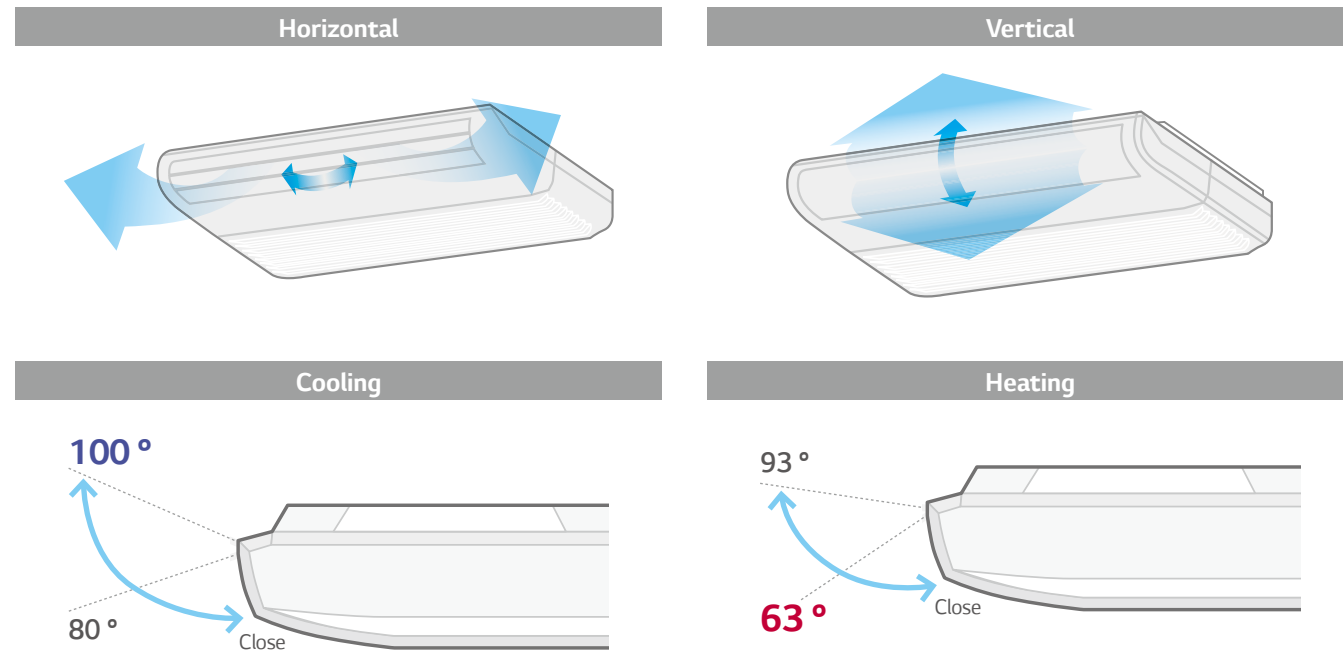

INDOOR				CV18 NJ2	CV24 NJ2
Capacity	Cooling / Heating	Nom	kW	5.3 / 5.8	7.0 / 7.7
Power Input		Nom	W	50	60
Running Current		Nom	A	0.4	0.6
Power Supply			Ø / V / Hz	1 / 220-240 / 50	1 / 220-240 / 50
Air Flow Rate		H / M / L	m ³ /min	12.4 / 11.4 / 10.4	13.9 / 12.9 / 11.9
Sound Pressure	Cooling	H / M / L	dBA	42 / 40 / 39	44 / 43 / 41
Sound Power	Cooling	Max	dBA	57	61
Dehumidification Rate			l/h	2.3	3.2
Dimensions	Body	W x H x D	mm	950 x 650 x 220	950 x 650 x 220
Net Weight	Body		kg	22.0	23.0
Piping	Liquid		mm (inch)	Ø6.35 (1/4)	Ø6.35 (1/4)
Connection	Gas		mm (inch)	Ø12.7 (1/2)	Ø12.7 (1/2)

Note : 1. Capacities are based on the following conditions :
 Cooling : - Indoor Temperature 27°C (80.6°F) DB / 19°C (66.2°F) WB - Outdoor Temperature 35°C (95°F) DB / 24°C (75.2°F) WB
 Heating : - Indoor Temperature 20°C (68°F) DB / 15°C (59°F) WB - Outdoor Temperature 7°C (44.6°F) DB / 6°C (42.8°F) WB
 Piping Length - Interconnecting Piping Length 7.5m - Level Difference of Zero
 2. Definition of Power Input Nominal conditions - Performance tested under EN14511
 3. Due to our policy of innovation some specifications may be changed without notification
 4. This product contains fluorinated greenhouse gases (R410A)

CONSOLE

Optimised Air Flow for Cooling & Heating

During the cooling operation, the vane adjusts upwards to direct the air flow towards the ceiling. When heating, the vane directs the warm air downwards to balance the room temperature especially for floor.

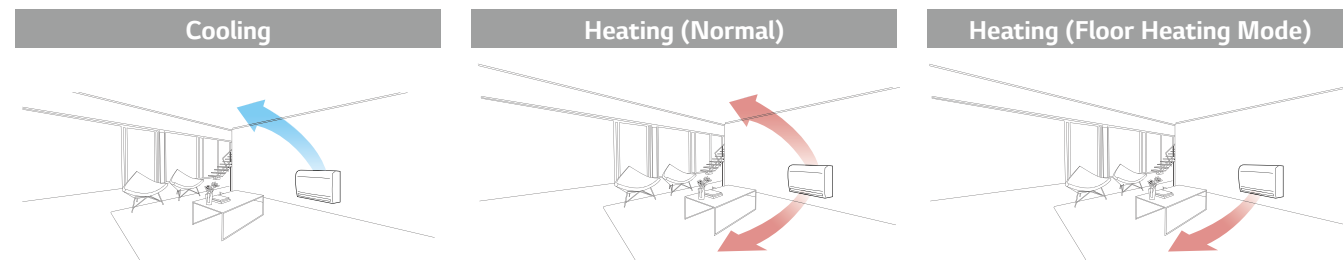

Quick Floor Heating

Console air conditioners offer a fast and powerful performance. Using the floor heating mode, console air conditioners provide faster floor heating and help to reach the desired temperature quickly.

	Company A	Electric Heater	LG	LG Floor Heating Mode
Vertical				
Horizontal				
Lead Time for Heating (13°C - 21°C)	12 minutes 30 seconds	50 minutes	9 minutes 30 seconds	8 minutes 40 seconds

(Test Condition :Target Temp 23°C, Indoor Room : 13°C-, Outdoor Room : 7°C)

5-Step Vane Control

There are 5 different stages to control air flow direction.

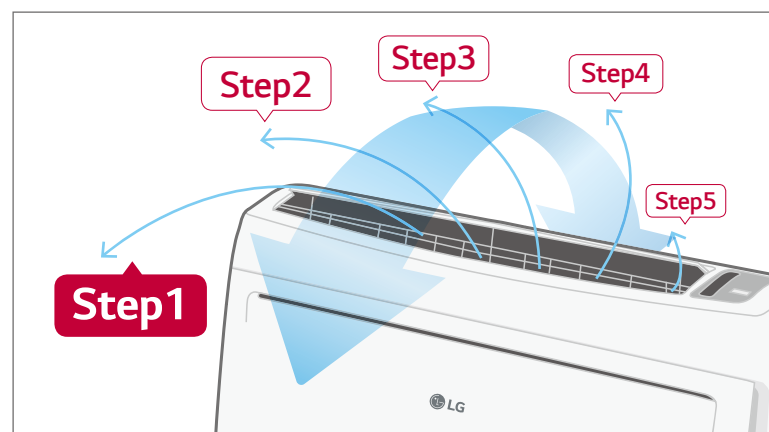

CAPACITY (KW)		2.6	3.5	5.3
Console		CQ09 NAO	CQ12 NAO	CQ18 NAO

INDOOR				CQ09 NAO
Capacity	Cooling / Heating	Nom	kW	2.6 / 2.9
Power Input		Nom	W	20
Running Current		Nom	A	0.6
Power Supply			Ø / V / Hz	1 / 220-240 / 50
Air Flow Rate		H / M / L	m ³ /min	8.5 / 6.7 / 5.0
Sound Pressure	Cooling	H / M / L	dBA	38 / 32 / 27
Sound Power	Cooling	Max	dBA	53
Dehumidification Rate			l/h	1.2
Dimensions	Body	W x H x D	mm	700 x 600 x 210
Net Weight	Body		kg	14.0
Piping Connection	Liquid		mm (inch)	Ø6.35 (1/4)
	Gas		mm (inch)	Ø9.52 (3/8)

* CQ09, CQ12, CQ18 are compatible between SCAC and MULTI.

INDOOR				CQ12 NAO	CQ18 NAO
Capacity	Cooling / Heating	Nom	kW	3.5 / 3.9	5.3 / 5.8
Power Input		Nom	W	20	40
Running Current		Nom	A	0.6	0.7
Power Supply			Ø / V / Hz	1 / 220-240 / 50	1 / 220-240 / 50
Air Flow Rate		H / M / L	m ³ /min	9.0 / 6.9 / 5.2	10.1 / 8.6 / 7.2
Sound Pressure	Cooling	H / M / L	dBA	39 / 32 / 27	44 / 39 / 35
Sound Power	Cooling	Max	dBA	56	60
Dehumidification Rate			l/h	1.4	2.3
Dimensions	Body	W x H x D	mm	700 x 600 x 210	700 x 600 x 210
Net Weight	Body		kg	14.0	14.0
Piping Connection	Liquid		mm (inch)	Ø6.35 (1/4)	Ø6.35 (1/4)
	Gas		mm (inch)	Ø9.52 (3/8)	Ø12.7 (1/2)

Note: 1. Capacities are based on the following conditions:
 Cooling : - Indoor Temperature 27°C (80.6°F) DB / 19°C (66.2°F) WB - Outdoor Temperature 35°C (95°F) DB / 24°C (75.2°F) WB
 Heating : - Indoor Temperature 20°C (68°F) DB / 15°C (59°F) WB - Outdoor Temperature 7°C (44.6°F) DB / 6°C (42.8°F) WB
 Piping Length - Interconnecting Piping Length 7.5m - Level Difference of Zero
 2. Definition of Power Input Nominal conditions - Performance tested under EN14511
 3. Due to our policy of innovation some specifications may be changed without notification
 4. This product contains fluorinated greenhouse gases (R410A)

ACCESSORIES

Distributor Box

PMBD3620, PMBD3630, PMBD3640

Easy installation using the range of Distributor Boxes.

For	2 Indoors	3 Indoors	4 Indoors
Distributor	 PMBD3620	 PMBD3630	 PMBD3640

Various distributors can make much easier installation for any sites

Features

- Distribution of refrigerant to various indoor units.
- 3 models (2, 3, 4 Indoor Units)
- EEV included
- Controlling PCB inside the unit
- Internally insulated (Prevents any chances of drainage)
- Flare joints for easy and clean installation
- Compact design (Low height)
- Flexible installation



Specification

		PMBD3620	PMBD3630	PMBD3640
Connectable Indoor Units	Number of Indoor Units	1 - 2	1 - 3	1 - 4
	Capacity	5k / 7k / 9k / 12k / 18k / 24k	5k / 7k / 9k / 12k / 18k / 24k	5k / 7k / 9k / 12k / 18k / 24k
Power Source	Ø / V / Hz	1 / 220-240 / 50	1 / 200-240 / 50	1 / 200-240 / 50
Power Consumption	W	10	10	10
Running Current	A	0.05	0.05	0.05
Dimensions	W x H x D	302 x 143 x 252 (11.9 x 5.6 x 9.9)	302 x 143 x 252 (11.9 x 5.6 x 9.9)	302 x 143 x 252 (11.9 x 5.6 x 9.9)
Net Weight	kg/lb	4.8 / 10.6	4.9 / 10.8	5 / 11
Piping Connection (To Outdoor Unit)	Liquid	mm (inch)	Ø9.52 (3/8)	Ø9.52(3/8)
	Gas	mm (inch)	Ø19.05 (3/4)	Ø19.05(3/4)
Piping Connection (To Indoor Unit)	Liquid	mm (inch)	Ø6.35 (1/4) x 2EA	Ø6.35 (1/4) x 3EA
	Gas	mm (inch)	Ø9.52 (3/8) x 2EA	Ø9.52 (3/8) x 3EA
Accessories	Hanger (Bracket)	EA	4	4
	Screw	EA	8	8
	Manual	EA	1	1

- Note :
1. The piping connection must be suit the piping sizes of the indoor unit which will be connected. (If need, use the connector which is included in the indoor unit)
 2. The BD should be installed inside the building.

Note : Due to our policy of innovation some specifications may be changed without notification.

Y Branch and Branch Kit

PMBL5620 (2 units) / PMBL1203F0 (3 units)





Features

- Y Branch and Branch kit make Multi FDX installation much easier.
- Y Branch and Branch kit for both gas and liquid are provided.
- Insulation material is also provided for covering the branches.

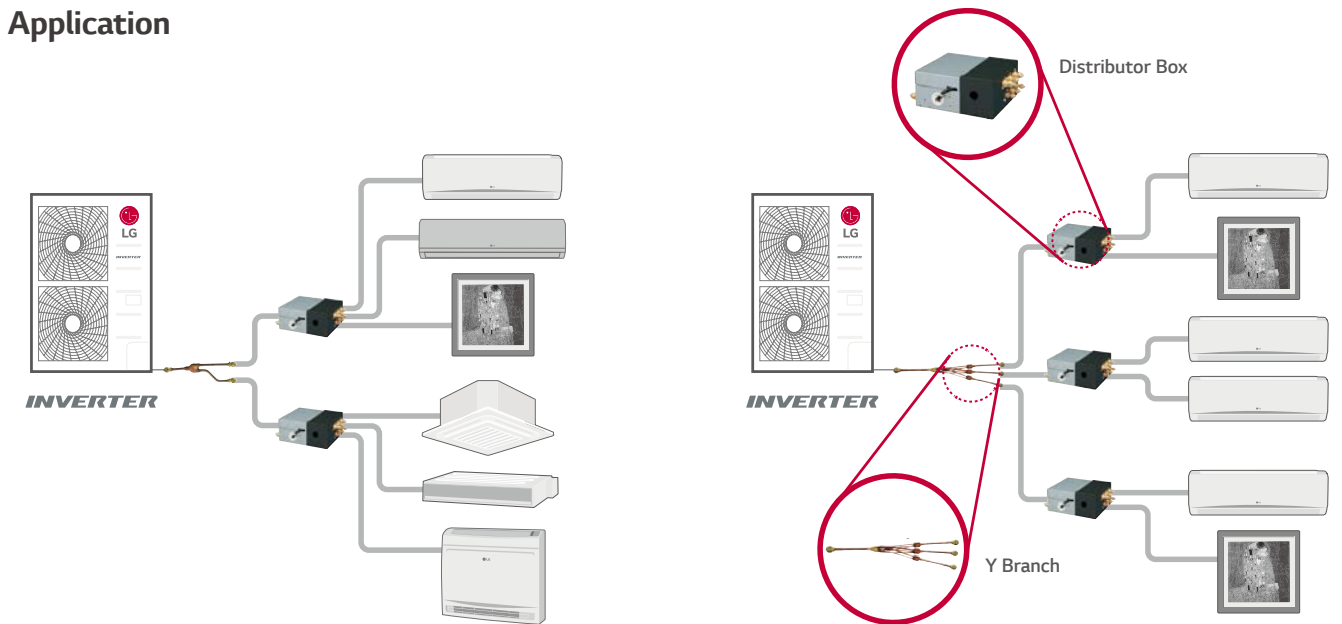
Application

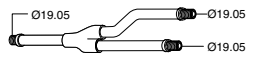
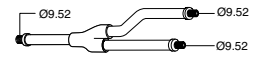

Accessory Model Name

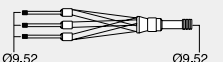
MODEL NAME	NO. OF BRANCH DISTRIBUTION UNITS	APPLICABLE MODEL	SPECIFICATION	
			GAS	Liquid
PMBL5620	2 Units	1Ø, 3Ø		
PMBL1203F0	3 Units	1Ø, 3Ø		

(Unit : mm)

COMBINATION TABLE

MU2R15 / MU2M15

Operation	Combination (kBtu/h)			Cooling										
				Each Capacity (kW)		Total Capacity						Total Input (W)		
	UNIT-A	UNIT-B	Total	UNIT-A	UNIT-B	Min		Rated		Max		Min	Rated	Max
1 UNIT	5		5	1.5	-	3,000	0.9	5,000	1.5	5,750	1.7	229	386	483
	7		7	2.1	-	4,200	1.2	7,000	2.1	8,050	2.4	307	547	692
	9		9	2.6	-	5,400	1.6	9,000	2.6	10,350	3.0	412	684	875
	12		12	3.5	-	7,200	2.1	12,000	3.5	13,800	4.0	547	937	1,190
2 UNIT	5	5	10	1.5	1.5	6,000	1.8	10,000	2.9	11,500	3.4	419	691	900
	5	7	12	1.5	2.1	7,200	2.1	12,000	3.5	13,800	4.0	492	843	1,120
	5	9	14	1.5	2.6	8,400	2.5	14,000	4.1	16,100	4.7	591	1,000	1,379
	7	7	14	2.1	2.1	8,400	2.5	14,000	4.1	16,100	4.7	591	1,000	1,379
	7	9	16	1.8	2.3	8,400	2.5	14,000	4.1	16,100	4.7	591	1,000	1,379
	5	12	17	1.2	2.9	8,400	2.5	14,000	4.1	16,100	4.7	591	1,000	1,379
	9	9	18	2.1	2.1	8,400	2.5	14,000	4.1	16,100	4.7	591	1,000	1,379
	7	12	19	1.5	2.6	8,400	2.5	14,000	4.1	16,100	4.7	591	1,000	1,379
	9	12	21	1.8	2.3	8,400	2.5	14,000	4.1	16,100	4.7	591	1,000	1,379

MU2R17 / MU2M17

Operation	Combination (kBtu/h)			Cooling										
				Each Capacity (kW)		Total Capacity						Total Input (W)		
	UNIT-A	UNIT-B	Total	UNIT-A	UNIT-B	Min		Rated		Max		Min	Rated	Max
1 UNIT	5		5	1.5	-	3,000	0.9	5,000	1.5	5,750	1.7	229	386	483
	7		7	2.1	-	4,200	1.2	7,000	2.1	8,050	2.4	307	547	692
	9		9	2.6	-	5,400	1.6	9,000	2.6	10,350	3.0	412	684	875
	12		12	3.5	-	7,200	2.1	12,000	3.5	13,800	4.0	547	937	1,190
2 UNIT	15		15	4.2	-	8,520	2.5	14,200	4.2	16,330	4.8	656	1,196	1,588
	5	5	10	1.5	1.5	6,000	1.8	10,000	2.9	11,500	3.4	419	691	900
	5	7	12	1.5	2.1	7,200	2.1	12,000	3.5	13,800	4.0	492	843	1,071
	5	9	14	1.5	2.6	8,400	2.5	14,000	4.1	16,100	4.7	591	1,000	1,379
	7	7	14	2.1	2.1	8,400	2.5	14,000	4.1	16,100	4.7	591	1,000	1,379
	7	9	16	2.1	2.6	9,600	2.8	16,000	4.7	18,400	5.4	665	1,253	1,699
	5	12	17	1.4	3.3	9,600	2.8	16,000	4.7	18,400	5.4	665	1,253	1,699
	9	9	18	2.3	2.3	9,600	2.8	16,000	4.7	18,400	5.4	665	1,253	1,699
	7	12	19	1.7	3.0	9,600	2.8	16,000	4.7	18,400	5.4	665	1,253	1,699
	5	15	20	1.2	3.5	9,600	2.8	16,000	4.7	18,400	5.4	665	1,253	1,699
	9	12	21	2.0	2.7	9,600	2.8	16,000	4.7	18,400	5.4	665	1,253	1,699
	7	15	22	1.5	3.2	9,600	2.8	16,000	4.7	18,400	5.4	665	1,253	1,699

Operation	Combination (kBtu/h)			Heating										
				Each Capacity (kW)		Total Capacity						Total Input (W)		
	UNIT-A	UNIT-B	Total	UNIT-A	UNIT-B	Min		Rated		Max		Min	Rated	Max
1 UNIT	5		5	1.6	-	3,300	1.0	5,500	1.6	6,050	1.8	235	380	472
	7		7	2.5	-	5,040	1.5	8,400	2.5	9,240	2.7	355	604	721
	9		9	3.2	-	6,480	1.9	10,800	3.2	11,880	3.5	454	784	949
	12		12	3.9	-	7,920	2.3	13,200	3.9	14,520	4.3	554	969	1,185
2 UNIT	5	5	10	1.6	1.6	6,600	1.9	11,000	3.2	12,100	3.5	408	706	854
	5	7	12	1.6	2.3	7,920	2.3	13,200	3.9	14,520	4.3	498	872	1,066
	5	9	14	1.7	3.0	9,600	2.8	16,000	4.7	18,400	5.4	613	1,068	1,451
	7	7	14	2.3	2.3	9,600	2.8	16,000	4.7	18,400	5.4	613	1,068	1,451
	7	9	16	2.1	2.6	9,600	2.8	16,000	4.7	18,400	5.4	613	1,068	1,451
	5	12	17	1.4	3.3	9,600	2.8	16,000	4.7	18,400	5.4	613	1,068	1,451
	9	9	18	2.3	2.3	9,600	2.8	16,000	4.7	18,400	5.4	613	1,068	1,451
	7	12	19	1.7	3.0	9,600	2.8	16,000	4.7	18,400	5.4	613	1,068	1,451
	9	12	21	2.0	2.7	9,600	2.8	16,000	4.7	18,400	5.4	613	1,068	1,451

Operation	Combination (kBtu/h)			Heating										
				Each Capacity (kW)		Total Capacity						Total Input (W)		
	UNIT-A	UNIT-B	Total	UNIT-A	UNIT-B	Min		Rated		Max		Min	Rated	Max
1 UNIT	5		5	1.6	-	3,300	1.0	5,500	1.6	6,050	1.8	235	380	472
	7		7	2.5	-	5,040	1.5	8,400	2.5	9,240	2.7	355	604	721
	9		9	3.2	-	6,480	1.9	10,800	3.2	11,880	3.5	454	784	920
	12		12	3.9	-	7,920	2.3	13,200	3.9	14,520	4.3	554	942	1,155
2 UNIT	15		15	4.8	-	9,900	2.9	16,500	4.8	18,150	5.3	706	1,187	1,504
	5	5	10	1.6	1.6	6,600	1.9	11,000	3.2	12,100	3.5	408	706	854
	5	7	12	1.6	2.3	7,920	2.3	13,200	3.9	14,520	4.3	498	872	1,066
	5	9	14	1.7	3.0	9,600	2.8	16,000	4.7	18,400	5.4	613	1,068	1,451
	7	7	14	2.3	2.3	9,600	2.8	16,000	4.7	18,400	5.4	613	1,068	1,451
	7	9	16	2.3	3.0	10,800	3.2	18,000	5.3	19,400	5.7	706	1,197	1,652
	5	12	17	1.6	3.7	10,800	3.2	18,000	5.3	19,400	5.7	706	1,197	1,652
	9	9	18	2.6	2.6	10,800	3.2	18,000	5.3	19,400	5.7	706	1,197	1,652
	7	12	19	1.9	3.3	10,800	3.2	18,000	5.3	19,400	5.7	706	1,197	1,652
	5	15	20	1.3	4.0	10,800	3.2	18,000	5.3	19,400	5.7	706	1,197	1,652
	9	12	21	2.3	3.0	10,800	3.2	18,000	5.3	19,400	5.7	706	1,197	1,652
	7	15	22	1.7	3.6	10,800	3.2	18,000	5.3	19,400	5.7	706	1,197	1,652

COMBINATION TABLE

MU3R19 / MU3M19

Operation	Combination (kBtu/h)				Cooling											
					Each Capacity (kW)			Total Capacity						Total Input (W)		
	UNIT-A	UNIT-B	UNIT-C	Total	UNIT-A	UNIT-B	UNIT-C	Min		Rated		Max		Min	Rated	Max
1 UNIT	5			5	1.5	-	-	3,600	1.1	5,000	1.5	6,000	1.8	256	388	564
	7			7	2.1	-	-	4,200	1.2	7,000	2.1	8,400	2.5	280	503	667
	9			9	2.6	-	-	5,400	1.6	9,000	2.6	10,800	3.2	378	633	872
	12			12	3.5	-	-	7,200	2.1	12,000	3.5	14,400	4.2	503	875	1,179
	15			15	4.2	-	-	8,520	2.5	14,200	4.2	17,040	5.0	606	1,072	1,366
	18			18	5.3	-	-	10,800	3.2	18,000	5.3	21,600	6.3	793	1,398	1,890
2 UNIT	5	5		10	1.5	1.5	-	6,000	1.8	10,000	2.9	12,000	3.5	406	676	914
	5	7		12	1.5	2.1	-	7,200	2.1	12,000	3.5	14,400	4.2	478	831	1,120
	5	9		14	1.5	2.6	-	8,400	2.5	14,000	4.1	16,800	4.9	576	991	1,335
	7	7		14	2.1	2.1	-	8,400	2.5	14,000	4.1	16,800	4.9	576	991	1,335
	7	9		16	2.1	2.6	-	9,600	2.8	16,000	4.7	19,200	5.6	651	1,157	1,573
	5	12		17	1.5	3.5	-	10,200	3.0	17,000	5.0	20,400	6.0	702	1,242	1,720
	9	9		18	2.6	2.6	-	10,800	3.2	18,000	5.3	21,600	6.3	753	1,328	1,842
	7	12		19	1.9	3.3	-	10,800	3.2	18,000	5.3	21,600	6.3	753	1,328	1,842
	5	15		20	1.3	4.0	-	10,800	3.2	18,000	5.3	21,600	6.3	753	1,328	1,842
	9	12		21	2.3	3.0	-	10,800	3.2	18,000	5.3	21,600	6.3	753	1,328	1,842
	7	15		22	1.7	3.6	-	10,800	3.2	18,000	5.3	21,600	6.3	753	1,328	1,842
	5	18		23	1.1	4.1	-	10,800	3.2	18,000	5.3	21,600	6.3	753	1,328	1,842
	9	15		24	2.0	3.3	-	10,800	3.2	18,000	5.3	21,600	6.3	753	1,328	1,842
	12	12		24	2.6	2.6	-	10,800	3.2	18,000	5.3	21,600	6.3	753	1,328	1,842
	7	18		25	1.5	3.8	-	10,800	3.2	18,000	5.3	21,600	6.3	753	1,328	1,842
	9	18		27	1.8	3.5	-	10,800	3.2	18,000	5.3	21,600	6.3	753	1,328	1,842
	12	15		27	2.3	2.9	-	10,800	3.2	18,000	5.3	21,600	6.3	753	1,328	1,842
	12	18		30	2.1	3.2	-	10,800	3.2	18,000	5.3	21,600	6.3	753	1,328	1,842
15	15		30	2.6	2.6	-	10,800	3.2	18,000	5.3	21,600	6.3	753	1,328	1,842	
3 UNIT	5	5	5	15	1.5	1.5	1.5	9,000	2.6	15,000	4.4	18,000	5.3	571	1,020	1,388
	5	5	7	17	1.5	1.5	2.1	10,200	3.0	17,000	5.0	20,400	6.0	667	1,180	1,634
	5	5	9	19	1.4	1.4	2.5	10,800	3.2	18,000	5.3	21,600	6.3	715	1,262	1,745
	5	7	7	19	1.4	1.9	1.9	10,800	3.2	18,000	5.3	21,600	6.3	715	1,262	1,745
	5	7	9	21	1.3	1.8	2.3	10,800	3.2	18,000	5.3	21,600	6.3	715	1,262	1,745
	7	7	7	21	1.8	1.8	1.8	10,800	3.2	18,000	5.3	21,600	6.3	715	1,262	1,745
	5	5	12	22	1.2	1.2	2.9	10,800	3.2	18,000	5.3	21,600	6.3	715	1,262	1,745
	5	9	9	23	1.1	2.1	2.1	10,800	3.2	18,000	5.3	21,600	6.3	715	1,262	1,745
	7	7	9	23	1.6	1.6	2.1	10,800	3.2	18,000	5.3	21,600	6.3	715	1,262	1,745
	5	7	12	24	1.1	1.5	2.6	10,800	3.2	18,000	5.3	21,600	6.3	715	1,262	1,745
	5	5	15	25	1.1	1.1	3.2	10,800	3.2	18,000	5.3	21,600	6.3	715	1,262	1,745
	7	9	9	25	1.5	1.9	1.9	10,800	3.2	18,000	5.3	21,600	6.3	715	1,262	1,745
	5	9	12	26	1.0	1.8	2.4	10,800	3.2	18,000	5.3	21,600	6.3	715	1,262	1,745
	7	7	12	26	1.4	1.4	2.4	10,800	3.2	18,000	5.3	21,600	6.3	715	1,262	1,745
	5	7	15	27	1.0	1.4	2.9	10,800	3.2	18,000	5.3	21,600	6.3	715	1,262	1,745
	9	9	9	27	1.8	1.8	1.8	10,800	3.2	18,000	5.3	21,600	6.3	715	1,262	1,745
	7	9	12	28	1.3	1.7	2.3	10,800	3.2	18,000	5.3	21,600	6.3	715	1,262	1,745
	5	9	15	29	0.9	1.6	2.7	10,800	3.2	18,000	5.3	21,600	6.3	715	1,262	1,745
	5	12	12	29	0.9	2.2	2.2	10,800	3.2	18,000	5.3	21,600	6.3	715	1,262	1,745
	7	7	15	29	1.3	1.3	2.7	10,800	3.2	18,000	5.3	21,600	6.3	715	1,262	1,745
	9	9	12	30	1.6	1.6	2.1	10,800	3.2	18,000	5.3	21,600	6.3	715	1,262	1,745

Operation	Combination (kBtu/h)				Heating											
					Each Capacity (kW)			Total Capacity						Total Input (W)		
	UNIT-A	UNIT-B	UNIT-C	Total	UNIT-A	UNIT-B	UNIT-C	Min		Rated		Max		Min	Rated	Max
1 UNIT	5			5	1.6	-	-	4,000	1.2	5,500	1.6	6,325	1.9	265	394	566
	7			7	2.5	-	-	5,040	1.5	8,400	2.5	9,660	2.8	335	575	715
	9			9	3.2	-	-	6,480	1.9	10,800	3.2	12,420	3.6	429	751	941
	12			12	3.9	-	-	7,920	2.3	13,200	3.9	15,180	4.4	526	935	1,178
	15			15	4.8	-	-	9,900	2.9	16,500	4.8	18,975	5.6	675	1,183	1,554
	18			18	5.8	-	-	11,880	3.5	19,800	5.8	22,770	6.7	829	1,472	1,922
2 UNIT	5	5		10	1.8	1.8	-	7,200	2.1	12,000	3.5	13,800	4.0	453	788	1,005
	5	7		12	1.8	2.5	-	8,640	2.5	14,400	4.2	16,560	4.9	546	965	1,265
	5	9		14	1.8	3.2	-	10,080	3.0	16,800	4.9	19,320	5.7	665	1,150	1,508
	7	7		14	2.5	2.5	-	10,080	3.0	16,800	4.9	19,320	5.7	665	1,150	1,508
	7	9		16	2.5	3.2	-	11,520	3.4	19,200	5.6	22,080	6.5	763	1,342	1,761
	5	12		17	1.8	4.2	-	12,240	3.6	20,400	6.0	23,460	6.9	813	1,456	1,892
	9	9		18	3.2	3.2	-	12,960	3.8	21,600	6.3	24,840	7.3	863	1,542	2,087
	7	12		19	2.3	4.0	-	12,960	3.8	21,600	6.3	24,840	7.3	863	1,542	2,087
	5	15		20	1.6	4.7	-	12,960	3.8	21,600	6.3	24,840	7.3	863	1,542	2,087
	9	12		21	2.7	3.6	-	12,960	3.8	21,600	6.3	24,840	7.3	863	1,542	2,087
	7	15		22	2.0	4.3	-	12,960	3.8	21,600	6.3	24,840	7.3	863	1,542	2,087
	5	18		23	1.4	5.0	-	12,960	3.8	21,600	6.3	24,840	7.3	863	1,542	2,087
	9	15		24	2.4	4.0	-	12,960	3.8	21,600	6.3	24,840	7.3	863	1,542	2,087
	12	12		24	3.2	3.2	-	12,960	3.8	21,600	6.3	24,840	7.3	863	1,542	2,087
	7	18		25	1.8	4.6	-	12,960	3.8	21,600	6.3	24,840	7.3	863	1,542	2,087
	9	18		27	2.1	4.2	-	12,960	3.8	21,600	6.3	24,840	7.3	863	1,542	2,087
	12	15		27	2.8	3.5	-	12,960	3.8	21,600	6.3	24,840	7.3	863	1,542	2,087
	12	18		30	2.5	3.8	-	12,960	3.8	21,600	6.3	24,840	7.3	863	1,542	2,087
15	15		30	3.2	3.2	-	12,960	3.8	21,600	6.3	24,840	7.3	863	1,542	2,087	
3 UNIT	5	5	5	15	1.8	1.8	1.8	10,800	3.2	18,000	5.3	20,700	6.1	678	1,196	1,551
	5	5	7	17	1.8	1.8	2.5	12,240	3.6	20,400	6.0	23,460	6.9	772	1,383	1,797
	5	5	9	19	1.7	1.7	3.0	12,960	3.8	21,600	6.3	24,840	7.3	820	1,465	2,001
	5	7	7	19	1.7	2.3	2.3	12,960	3.8	21,600	6.3	24,840	7.3	820	1,465	2,001
	5	7	9	21	1.5	2.1	2.7	12,960	3.8	21,600	6.3	24,840	7.3	820	1,465	2,001
	7	7	7	21	2.1	2.1	2.1	12,960	3.8	21,600	6.3	24,840	7.3	820	1,465	2,001
	5	5	12	22	1.4	1.4	3.5	12,960	3.8	21,600	6.3	24,840	7.3	820	1,465	2,001
	5	9	9	23	1.4	2.5	2.5	12,960	3.8	21,600	6.3	24,840	7.3	820	1,465	2,001
	7	7	9	23	1.9	1.9	2.5	12,960	3.8	21,600	6.3	24,840	7.3	820	1,465	2,001
	5	7	12	24	1.3	1.8	3.2	12,960	3.8	21,600	6.3	24,840	7.3	820	1,465	2,001
	5	5	15	25	1.3	1.3	3.8	12,960	3.8	21,600	6.3	24,840	7.3	820	1,465	2,001
	7	9	9	25	1.8	2.3	2.3	12,960	3.8	21,600	6.3	24,840	7.3	820	1,465	2,001
	5	9	12	26	1.2	2.2	2.9	12,960	3.8	21,600	6.3	24,840	7.3	820	1,465	2,001
	7	7	12	26	1.7	1.7	2.9	12,960	3.8	21,600	6.3	24,840	7.3	820	1,465	2,001
	5	7	15	27	1.2	1.6	3.5	12,960	3.8	21,600	6.3	24,840	7.3	820	1,465	2,001
	9															

COMBINATION TABLE

MU3R21 / MU3M21

Operation	Combination (kBtu/h)				Cooling											
					Each Capacity (kW)			Total Capacity						Total Input (W)		
	UNIT-A	UNIT-B	UNIT-C	Total	UNIT-A	UNIT-B	UNIT-C	Min		Rated		Max		Min	Rated	Max
1 UNIT	5				1.5	-	-	3,600	1.1	5,000	1.5	6,000	1.8	256	388	564
	7				2.1	-	-	4,200	1.2	7,000	2.1	8,400	2.5	280	503	667
	9				2.6	-	-	5,400	1.6	9,000	2.6	10,800	3.2	378	633	872
	12				3.5	-	-	7,200	2.1	12,000	3.5	14,400	4.2	503	875	1,179
	15				4.2	-	-	8,520	2.5	14,200	4.2	17,040	5.0	606	1,072	1,366
	18				5.3	-	-	10,800	3.2	18,000	5.3	21,600	6.3	793	1,398	1,890
2 UNIT	5	5	10		1.5	1.5	-	6,000	1.8	10,000	2.9	12,000	3.5	406	676	914
	5	7	12		1.5	2.1	-	7,200	2.1	12,000	3.5	14,400	4.2	478	831	1,120
	5	9	14		1.5	2.6	-	8,400	2.5	14,000	4.1	16,800	4.9	576	991	1,335
	7	7	14		2.1	2.1	-	8,400	2.5	14,000	4.1	16,800	4.9	576	991	1,335
	7	9	16		2.1	2.6	-	9,600	2.8	16,000	4.7	19,200	5.6	651	1,157	1,573
	5	12	17		1.5	3.5	-	10,200	3.0	17,000	5.0	20,400	6.0	702	1,242	1,720
	9	9	18		2.6	2.6	-	10,800	3.2	18,000	5.3	21,600	6.3	753	1,328	1,842
	7	12	19		2.1	3.5	-	11,400	3.3	19,000	5.6	22,800	6.7	779	1,430	2,039
	5	15	20		1.5	4.4	-	12,000	3.5	20,000	5.9	23,100	6.8	831	1,530	2,091
	9	12	21		2.6	3.5	-	12,600	3.7	21,000	6.2	23,100	6.8	884	1,632	2,091
	7	15	22		2.0	4.2	-	12,600	3.7	21,000	6.2	23,100	6.8	884	1,632	2,091
	5	18	23		1.3	4.8	-	12,600	3.7	21,000	6.2	23,100	6.8	884	1,632	2,091
	9	15	24		2.3	3.8	-	12,600	3.7	21,000	6.2	23,100	6.8	884	1,632	2,091
	12	12	24		3.1	3.1	-	12,600	3.7	21,000	6.2	23,100	6.8	884	1,632	2,091
	7	18	25		1.7	4.4	-	12,600	3.7	21,000	6.2	23,100	6.8	884	1,632	2,091
	9	18	27		2.1	4.1	-	12,600	3.7	21,000	6.2	23,100	6.8	884	1,632	2,091
	12	15	27		2.7	3.4	-	12,600	3.7	21,000	6.2	23,100	6.8	884	1,632	2,091
	12	18	30		2.5	3.7	-	12,600	3.7	21,000	6.2	23,100	6.8	884	1,632	2,091
15	15	30		3.1	3.1	-	12,600	3.7	21,000	6.2	23,100	6.8	884	1,632	2,091	
15	18	33		2.8	3.4	-	12,600	3.7	21,000	6.2	23,100	6.8	884	1,632	2,091	
3 UNIT	5	5	5	15	1.5	1.5	1.5	9,000	2.6	15,000	4.4	18,000	5.3	571	1,020	1,388
	5	5	7	17	1.5	1.5	2.1	10,200	3.0	17,000	5.0	20,400	6.0	667	1,180	1,634
	5	5	9	19	1.5	1.5	2.6	11,400	3.3	19,000	5.6	22,800	6.7	740	1,359	1,908
	5	7	7	19	1.5	2.1	2.1	11,400	3.3	19,000	5.6	22,800	6.7	740	1,359	1,908
	5	7	9	21	1.5	2.1	2.6	12,600	3.7	21,000	6.2	25,000	7.3	840	1,550	2,169
	7	7	7	21	2.1	2.1	2.1	12,600	3.7	21,000	6.2	25,000	7.3	840	1,550	2,169
	5	5	12	22	1.4	1.4	3.4	12,600	3.7	21,000	6.2	25,000	7.3	840	1,550	2,169
	5	9	9	23	1.3	2.4	2.4	12,600	3.7	21,000	6.2	25,000	7.3	840	1,550	2,169
	7	7	9	23	1.9	1.9	2.4	12,600	3.7	21,000	6.2	25,000	7.3	840	1,550	2,169
	5	7	12	24	1.3	1.8	3.1	12,600	3.7	21,000	6.2	25,000	7.3	840	1,550	2,169
	5	5	15	25	1.2	1.2	3.7	12,600	3.7	21,000	6.2	25,000	7.3	840	1,550	2,169
	7	9	9	25	1.7	2.2	2.2	12,600	3.7	21,000	6.2	25,000	7.3	840	1,550	2,169
	5	9	12	26	1.2	2.1	2.8	12,600	3.7	21,000	6.2	25,000	7.3	840	1,550	2,169
	7	7	12	26	1.7	1.7	2.8	12,600	3.7	21,000	6.2	25,000	7.3	840	1,550	2,169
	5	7	15	27	1.1	1.6	3.4	12,600	3.7	21,000	6.2	25,000	7.3	840	1,550	2,169
	9	9	9	27	2.1	2.1	2.1	12,600	3.7	21,000	6.2	25,000	7.3	840	1,550	2,169
	5	5	18	28	1.1	1.1	4.0	12,600	3.7	21,000	6.2	25,000	7.3	840	1,550	2,169
	7	9	12	28	1.5	2.0	2.6	12,600	3.7	21,000	6.2	25,000	7.3	840	1,550	2,169
	5	9	15	29	1.1	1.9	3.2	12,600	3.7	21,000	6.2	25,000	7.3	840	1,550	2,169
	5	12	12	29	1.1	2.5	2.5	12,600	3.7	21,000	6.2	25,000	7.3	840	1,550	2,169
	7	7	15	29	1.5	1.5	3.2	12,600	3.7	21,000	6.2	25,000	7.3	840	1,550	2,169
	5	7	18	30	1.0	1.4	3.7	12,600	3.7	21,000	6.2	25,000	7.3	840	1,550	2,169
	9	9	12	30	1.8	1.8	2.5	12,600	3.7	21,000	6.2	25,000	7.3	840	1,550	2,169
	7	9	15	31	1.4	1.8	3.0	12,600	3.7	21,000	6.2	25,000	7.3	840	1,550	2,169
7	12	12	31	1.4	2.4	2.4	12,600	3.7	21,000	6.2	25,000	7.3	840	1,550	2,169	
5	12	15	32	1.0	2.3	2.9	12,600	3.7	21,000	6.2	25,000	7.3	840	1,550	2,169	
5	9	18	32	1.0	1.7	3.5	12,600	3.7	21,000	6.2	25,000	7.3	840	1,550	2,169	
7	7	18	32	1.3	1.3	3.5	12,600	3.7	21,000	6.2	25,000	7.3	840	1,550	2,169	
9	9	15	33	1.7	1.7	2.8	12,600	3.7	21,000	6.2	25,000	7.3	840	1,550	2,169	
9	12	12	33	1.7	2.2	2.2	12,600	3.7	21,000	6.2	25,000	7.3	840	1,550	2,169	

Operation	Combination (kBtu/h)				Heating											
					Each Capacity (kW)			Total Capacity						Total Input (W)		
	UNIT-A	UNIT-B	UNIT-C	Total	UNIT-A	UNIT-B	UNIT-C	Min		Rated		Max		Min	Rated	Max
1 UNIT	5				1.6	-	-	4,000	1.2	5,500	1.6	6,325	1.9	265	394	566
	7				2.5	-	-	5,040	1.5	8,400	2.5	9,660	2.8	335	575	715
	9				3.2	-	-	6,480	1.9	10,800	3.2	12,420	3.6	429	751	941
	12				3.9	-	-	7,920	2.3	13,200	3.9	15,180	4.4	526	935	1,178
	15				4.8	-	-	9,900	2.9	16,500	4.8	18,975	5.6	675	1,183	1,554
	18				5.8	-	-	11,880	3.5	19,800	5.8	22,770	6.7	829	1,472	1,922
2 UNIT	5	5	10		1.8	1.8	-	7,200	2.1	12,000	3.5	13,800	4.0	453	788	1,005
	5	7	12		1.8	2.5	-	8,640	2.5	14,400	4.2	16,560	4.9	546	965	1,265
	5	9	14		1.8	3.2	-	10,080	3.0	16,800	4.9	19,320	5.7	665	1,150	1,508
	7	7	14		2.5	2.5	-	10,080	3.0	16,800	4.9	19,320	5.7	665	1,150	1,508
	7	9	16		2.5	3.2	-	11,520	3.4	19,200	5.6	22,080	6.5	763	1,342	1,761
	5	12	17		1.8	4.2	-	12,240	3.6	20,400	6.0	23,460	6.9	813	1,399	1,892
	9	9	18		3.2	3.2	-	12,960	3.8	21,600	6.3	24,840	7.3	863	1,484	2,087
	7	12	19		2.4	4.1	-	13,320	3.9	22,200	6.5	25,530	7.5	888	1,542	2,196
	5	15	20		1.7	5.0	-	13,740	4.0	22,900	6.7	26,335	7.7	914	1,601	2,310
	9	12	21		3.0	4.0	-	14,400	4.2	24,000	7.0	26,500	7.8	965	1,690	2,368
	7	15	22		2.2	4.8	-	14,400	4.2	24,000	7.0	26,500	7.8	965	1,690	2,368
	5	18	23		1.5	5.5	-	14,400	4.2	24,000	7.0	26,500	7.8	965	1,690	2,368
	9	15	24		2.6	4.4	-	14,400	4.2	24,000	7.0	26,500	7.8	965	1,690	2,368
	12	12	24		3.5	3.5	-	14,400	4.2	24,000	7.0	26,500	7.8	965	1,690	2,368
	7	18	25		2.0	5.1	-	14,400	4.2	24,000	7.0	26,500	7.8	965	1,690	2,368
	9	18	27		2.3	4.7	-	14,400	4.2	24,000	7.0	26,500				

COMBINATION TABLE

MU4R25 / MU4M25

Operation	Combination (kBtu/h)					Cooling												
						Each Capacity (kW)				Total Capacity						Total Input (W)		
	UNIT-A	UNIT-B	UNIT-C	UNIT-D	Total	UNIT-A	UNIT-B	UNIT-C	UNIT-D	Min	Rated	Max	Min	Rated	Max			
1 UNIT	5				5	1.5	-	-	-	4,500	1.3	5,000	1.5	6,000	1.8	416	467	684
	7				7	2.1	-	-	-	4,800	1.4	7,000	2.1	8,400	2.5	416	551	741
	9				9	2.6	-	-	-	5,400	1.6	9,000	2.6	10,800	3.2	416	689	961
	12				12	3.5	-	-	-	7,200	2.1	12,000	3.5	14,400	4.2	551	944	1,287
	15				15	4.2	-	-	-	8,520	2.5	14,200	4.2	17,040	5.0	661	1,149	1,557
	18				18	5.3	-	-	-	10,800	3.2	18,000	5.3	21,600	6.3	858	1,482	2,013
	24				24	7.0	-	-	-	14,400	4.2	24,000	7.0	25,500	7.5	1,149	2,026	2,830
	5	5			10	1.5	1.5	-	-	6,000	1.8	10,000	2.9	12,000	3.5	423	696	952
	5	7			12	1.5	2.1	-	-	7,200	2.1	12,000	3.5	14,400	4.2	496	850	1,158
	5	9			14	1.5	2.6	-	-	8,400	2.5	14,000	4.1	16,800	4.9	595	1,034	1,370
7	7			14	2.1	2.1	-	-	8,400	2.5	14,000	4.1	16,800	4.9	595	1,034	1,370	
7	9			16	2.1	2.6	-	-	9,600	2.8	16,000	4.7	19,200	5.6	670	1,196	1,588	
5	12			17	1.5	3.5	-	-	10,200	3.0	17,000	5.0	20,400	6.0	721	1,279	1,715	
9	9			18	2.6	2.6	-	-	10,800	3.2	18,000	5.3	21,600	6.3	772	1,362	1,812	
7	12			19	2.1	3.5	-	-	11,400	3.3	19,000	5.6	22,800	6.7	798	1,446	1,943	
5	15			20	1.5	4.4	-	-	12,000	3.5	20,000	5.9	24,000	7.0	850	1,532	2,042	
9	12			21	2.6	3.5	-	-	12,600	3.7	21,000	6.2	24,150	7.1	902	1,618	2,089	
7	15			22	2.1	4.4	-	-	13,200	3.9	22,000	6.4	25,300	7.4	955	1,676	2,230	
5	18			23	1.5	5.3	-	-	13,800	4.0	23,000	6.7	26,450	7.8	981	1,764	2,426	
9	15			24	2.6	4.4	-	-	14,400	4.2	24,000	7.0	28,800	8.4	1,034	1,865	2,756	
12	12			24	3.5	3.5	-	-	14,400	4.2	24,000	7.0	28,800	8.4	1,034	1,865	2,756	
7	18			25	2.0	5.1	-	-	14,400	4.2	24,000	7.0	28,800	8.4	1,034	1,865	2,756	
9	18			27	2.3	4.7	-	-	14,400	4.2	24,000	7.0	28,800	8.4	1,034	1,865	2,756	
12	15			27	3.1	3.9	-	-	14,400	4.2	24,000	7.0	28,800	8.4	1,034	1,865	2,756	
5	24			29	1.2	5.8	-	-	14,400	4.2	24,000	7.0	28,800	8.4	1,034	1,865	2,756	
12	18			30	2.8	4.2	-	-	14,400	4.2	24,000	7.0	28,800	8.4	1,034	1,865	2,756	
15	15			30	3.5	3.5	-	-	14,400	4.2	24,000	7.0	29,000	8.5	1,034	1,865	2,814	
7	24			31	1.6	5.4	-	-	14,400	4.2	24,000	7.0	29,000	8.5	1,034	1,865	2,814	
9	24			33	1.9	5.1	-	-	14,400	4.2	24,000	7.0	29,000	8.5	1,034	1,865	2,814	
15	18			33	3.2	3.8	-	-	14,400	4.2	24,000	7.0	29,000	8.5	1,034	1,865	2,814	
18	18			36	3.5	3.5	-	-	14,400	4.2	24,000	7.0	29,000	8.5	1,034	1,865	2,814	
12	24			36	2.3	4.7	-	-	14,400	4.2	24,000	7.0	29,000	8.5	1,034	1,865	2,814	
5	5	5		15	1.5	1.5	1.5	-	9,000	2.6	15,000	4.4	18,000	5.3	583	1,023	1,405	
5	5	7		17	1.5	1.5	2.1	-	10,200	3.0	17,000	5.0	20,400	6.0	678	1,176	1,613	
5	5	9		19	1.5	1.5	2.6	-	11,400	3.3	19,000	5.6	22,800	6.7	750	1,333	1,826	
5	7	7		19	1.5	2.1	2.1	-	11,400	3.3	19,000	5.6	22,800	6.7	750	1,333	1,826	
5	7	9		21	1.5	2.1	2.6	-	12,600	3.7	21,000	6.2	25,200	7.4	848	1,494	2,096	
7	7	7		21	2.1	2.1	2.1	-	12,600	3.7	21,000	6.2	25,200	7.4	848	1,494	2,096	
5	5	12		22	1.5	1.5	3.5	-	13,200	3.9	22,000	6.4	26,400	7.7	897	1,548	2,234	
5	9	9		23	1.5	2.6	2.6	-	13,800	4.0	23,000	6.7	27,600	8.1	922	1,630	2,441	
7	7	9		23	2.1	2.1	2.6	-	13,800	4.0	23,000	6.7	27,600	8.1	922	1,630	2,441	
5	7	12		24	1.5	2.1	3.5	-	14,400	4.2	24,000	7.0	28,800	8.4	972	1,714	2,617	
5	5	15		25	1.4	1.4	4.2	-	14,400	4.2	24,000	7.0	28,800	8.4	972	1,714	2,617	
7	9	9		25	2.0	2.5	2.5	-	14,400	4.2	24,000	7.0	28,800	8.4	972	1,714	2,617	
5	9	12		26	1.4	2.4	3.2	-	14,400	4.2	24,000	7.0	28,800	8.4	972	1,714	2,617	
7	7	12		26	1.9	1.9	3.2	-	14,400	4.2	24,000	7.0	28,800	8.4	972	1,714	2,617	
5	7	15		27	1.3	1.8	3.9	-	14,400	4.2	24,000	7.0	28,800	8.4	972	1,714	2,617	
9	9	9		27	2.3	2.3	2.3	-	14,400	4.2	24,000	7.0	28,800	8.4	972	1,714	2,617	
7	9	12		28	1.8	2.3	3.0	-	14,400	4.2	24,000	7.0	28,800	8.4	972	1,714	2,617	
5	5	18		28	1.3	1.3	4.5	-	14,400	4.2	24,000	7.0	28,800	8.4	972	1,714	2,617	
5	9	15		29	1.2	2.2	3.6	-	14,400	4.2	24,000	7.0	28,800	8.4	972	1,714	2,617	
5	12	12		29	1.2	2.9	2.9	-	14,400	4.2	24,000	7.0	28,800	8.4	972	1,714	2,617	
7	7	15		29	1.7	1.7	3.6	-	14,400	4.2	24,000	7.0	28,800	8.4	972	1,714	2,617	
5	7	18		30	1.2	1.6	4.2	-	14,400	4.2	24,000	7.0	28,800	8.4	972	1,714	2,617	
9	9	12		30	2.1	2.1	2.8	-	14,400	4.2	24,000	7.0	28,800	8.4	972	1,714	2,617	
7	9	15		31	1.6	2.0	3.4	-	14,400	4.2	24,000	7.0	29,000	8.5	972	1,714	2,677	
7	12	12		31	1.6	2.7	2.7	-	14,400	4.2	24,000	7.0	29,000	8.5	972	1,714	2,677	
5	12	15		32	1.1	2.6	3.3	-	14,400	4.2	24,000	7.0	29,000	8.5	972	1,714	2,677	
5	9	18		32	1.1	2.0	4.0	-	14,400	4.2	24,000	7.0	29,000	8.5	972	1,714	2,677	
7	7	18		32	1.5	1.5	4.0	-	14,400	4.2	24,000	7.0	29,000	8.5	972	1,714	2,677	
9	9	15		33	1.9	1.9	3.2	-	14,400	4.2	24,000	7.0	29,000	8.5	972	1,714	2,677	
9	12	12		33	1.9	2.6	2.6	-	14,400	4.2	24,000	7.0	29,000	8.5	972	1,714	2,677	
7	9	18		34	1.4	1.9	3.7	-	14,400	4.2	24,000	7.0	29,000	8.5	972	1,714	2,677	
7	12	15		34	1.4	2.5	3.1	-	14,400	4.2	24,000	7.0	29,000	8.5	972	1,714	2,677	
5	5	24		34	1.0	1.0	5.0	-	14,400	4.2	24,000	7.0	29,000	8.5	972	1,714	2,677	
5	12	18		35	1.0	2.4	3.6	-	14,400	4.2	24,000	7.0	29,000	8.5	972	1,714	2,677	
5	15	15		35	1.0	3.0	3.0	-	14,400	4.2	24,000	7.0	29,000	8.5	972	1,714	2,677	
5	7	24		36	1.0	1.4	4.7	-	14,400	4.2	24,000	7.0	29,000	8.5	972	1,714	2,677	
9	12	15		36	1.8	2.3	2.9	-	14,400	4.2	24,000	7.0	29,000	8.5	972	1,714	2,677	
12	12	12		36	2.3	2.3	2.3	-	14,400	4.2	24,000	7.0	29,000	8.5	972	1,714	2,677	
9	9	18		36	1.8	1.8	3.5	-	14,400	4.2	24,000	7.0	29,000	8.5	972	1,714	2,677	
7	12	18		37	1.3	2.3	3.4	-	14,400	4.2	24,000	7.0	29,000	8.5	972	1,714	2,677	
7	15	15		37	1.3	2.9	2.9	-	14,400	4.2	24,000	7.0	29,000	8.5	972	1,714	2,677	
5	9	24		38	0.9	1.7	4.4	-	14,400	4.2	24,000	7.0	29,000	8.5	972	1,714	2,677	
5	15	18		38	0.9	2.8	3.3	-	14,400	4.2	24,000	7.0	29,000	8.5	972	1,714	2,677	
7	7	24		38	1.3	1.3	4.4	-	14,400	4.2	24,000	7.0	29,000	8.5	972	1,714	2,677	
9	12	18		39	1.6	2.2	3.2	-	14,400	4.2	24,000	7.0	29,000	8.5	972	1,714	2,677	
9	15	15		39	1.6	2.7	2.7	-	14,400	4.2	24,000	7.0	29,000	8.5	972	1,714	2,677	
12	12	15		39	2.2	2.2	2.7	-	14,400	4.2	24,000	7.0	29,000	8.5	972	1,714	2,677	

Operation	Combination (kBtu/h)					Cooling											
						Each Capacity (kW)				Total Capacity						Total Input (W)	
	UNIT-A	UNIT-B	UNIT-C	UNIT-D	Total	UNIT-A	UNIT-B	UNIT-C	UNIT-D	Min	Rated	Max	Min	Rated	Max		
1 UNIT	5				5	1.5	-	-	-	4,500	1.3	5,000	1.5	6,000			

COMBINATION TABLE

MU4R25 / MU4M25

Operation	Combination (kBtu/h)					Heating												
						Each Capacity (kW)				Total Capacity				Total Input (W)				
	UNIT-A	UNIT-B	UNIT-C	UNIT-D	Total	UNIT-A	UNIT-B	UNIT-C	UNIT-D	Min	Rated	Max	Min	Rated	Max			
1 UNIT	5				5	1.6	-	-	-	5,000	1.5	5,500	1.6	6,325	1.9	610	610	747
	7				7	2.5	-	-	-	5,500	1.6	8,400	2.5	9,660	2.8	610	665	862
	9				9	3.2	-	-	-	6,480	1.9	10,800	3.2	12,420	3.6	610	864	1,126
	12				12	3.9	-	-	-	7,920	2.3	13,200	3.9	15,180	4.4	610	1,067	1,399
	15				15	4.8	-	-	-	9,900	2.9	16,500	4.8	18,975	5.6	778	1,337	1,823
	18				18	5.8	-	-	-	11,880	3.5	19,800	5.8	22,770	6.7	950	1,649	2,230
	24				24	7.4	-	-	-	15,240	4.5	25,400	7.4	26,670	7.8	1,246	2,172	2,654
	5	5			10	1.8	1.8	-	-	7,200	2.1	12,000	3.5	14,400	4.2	471	808	1,130
	5	7			12	1.8	2.5	-	-	8,640	2.5	14,400	4.2	17,280	5.1	566	983	1,397
	5	9			14	1.8	3.2	-	-	10,080	3.0	16,800	4.9	20,160	5.9	685	1,163	1,643
	7	7			14	2.5	2.5	-	-	10,080	3.0	16,800	4.9	20,160	5.9	685	1,163	1,643
	7	9			16	2.5	3.2	-	-	11,520	3.4	19,200	5.6	23,040	6.8	783	1,348	1,928
5	12			17	1.8	4.2	-	-	12,240	3.6	20,400	6.0	24,480	7.2	832	1,456	2,057	
9	9			18	3.2	3.2	-	-	12,960	3.8	21,600	6.3	25,920	7.6	882	1,537	2,189	
7	12			19	2.5	4.2	-	-	13,680	4.0	22,800	6.7	27,360	8.0	932	1,648	2,323	
5	15			20	1.8	5.3	-	-	14,400	4.2	24,000	7.0	28,800	8.4	983	1,732	2,459	
9	12			21	3.2	4.2	-	-	15,120	4.4	25,200	7.4	30,240	8.9	1,034	1,846	2,644	
7	15			22	2.5	5.3	-	-	15,840	4.6	26,400	7.7	31,680	9.3	1,085	1,932	2,877	
5	18			23	1.8	6.3	-	-	16,560	4.9	27,600	8.1	32,000	9.4	1,163	2,049	2,955	
9	15			24	3.2	5.3	-	-	17,280	5.1	28,800	8.4	32,000	9.4	1,215	2,138	2,955	
12	12			24	4.2	4.2	-	-	17,280	5.1	28,800	8.4	32,000	9.4	1,215	2,138	2,955	
7	18			25	2.4	6.1	-	-	17,280	5.1	28,800	8.4	32,000	9.4	1,215	2,138	2,955	
9	18			27	2.8	5.6	-	-	17,280	5.1	28,800	8.4	32,000	9.4	1,215	2,138	2,955	
12	15			27	3.8	4.7	-	-	17,280	5.1	28,800	8.4	32,000	9.4	1,215	2,138	2,955	
5	24			29	1.5	7.0	-	-	17,280	5.1	28,800	8.4	32,000	9.4	1,215	2,138	2,955	
12	18			30	3.4	5.1	-	-	17,280	5.1	28,800	8.4	32,000	9.4	1,215	2,138	2,955	
15	15			30	4.2	4.2	-	-	17,280	5.1	28,800	8.4	32,000	9.4	1,215	2,138	2,955	
7	24			31	1.9	6.5	-	-	17,280	5.1	28,800	8.4	32,000	9.4	1,215	2,138	2,955	
9	24			33	2.3	6.1	-	-	17,280	5.1	28,800	8.4	32,000	9.4	1,215	2,138	2,955	
15	18			33	3.8	4.6	-	-	17,280	5.1	28,800	8.4	32,000	9.4	1,215	2,138	2,955	
18	18			36	4.2	4.2	-	-	17,280	5.1	28,800	8.4	32,000	9.4	1,215	2,138	2,955	
12	24			36	2.8	5.6	-	-	17,280	5.1	28,800	8.4	32,000	9.4	1,215	2,138	2,955	
5	5	5		15	1.8	1.8	1.8	-	10,800	3.2	18,000	5.3	21,600	6.3	690	1,192	1,662	
5	5	7		17	1.8	1.8	2.5	-	12,240	3.6	20,400	6.0	24,480	7.2	782	1,368	1,934	
5	5	9		19	1.8	1.8	3.2	-	13,680	4.0	22,800	6.7	27,360	8.0	876	1,549	2,183	
5	7	7		19	1.8	2.5	2.5	-	13,680	4.0	22,800	6.7	27,360	8.0	876	1,549	2,183	
5	7	9		21	1.8	2.5	3.2	-	15,120	4.4	25,200	7.4	30,240	8.9	972	1,735	2,486	
7	7	7		21	2.5	2.5	2.5	-	15,120	4.4	25,200	7.4	30,240	8.9	972	1,735	2,486	
5	5	12		22	1.8	1.8	4.2	-	15,840	4.6	26,400	7.7	31,680	9.3	1,020	1,817	2,650	
5	9	9		23	1.8	3.2	3.2	-	16,560	4.9	27,600	8.1	32,000	9.4	1,093	1,926	2,694	
7	7	9		23	2.5	2.5	3.2	-	16,560	4.9	27,600	8.1	32,000	9.4	1,093	1,926	2,694	
5	7	12		24	1.8	2.5	4.2	-	17,280	5.1	28,800	8.4	32,000	9.4	1,142	2,010	2,694	
5	5	15		25	1.7	1.7	5.1	-	17,280	5.1	28,800	8.4	32,000	9.4	1,142	2,010	2,694	
7	9	9		25	2.4	3.0	3.0	-	17,280	5.1	28,800	8.4	32,000	9.4	1,142	2,010	2,694	
5	9	12		26	1.6	2.9	3.9	-	17,280	5.1	28,800	8.4	32,000	9.4	1,142	2,010	2,694	
7	7	12		26	2.3	2.3	3.9	-	17,280	5.1	28,800	8.4	32,000	9.4	1,142	2,010	2,694	
5	7	15		27	1.6	2.2	4.7	-	17,280	5.1	28,800	8.4	32,000	9.4	1,142	2,010	2,694	
9	9	9		27	2.8	2.8	2.8	-	17,280	5.1	28,800	8.4	32,000	9.4	1,142	2,010	2,694	
7	9	12		28	2.1	2.7	3.6	-	17,280	5.1	28,800	8.4	32,000	9.4	1,142	2,010	2,694	
5	5	18		28	1.5	1.5	5.4	-	17,280	5.1	28,800	8.4	32,000	9.4	1,142	2,010	2,694	
5	9	15		29	1.5	2.6	4.4	-	17,280	5.1	28,800	8.4	32,000	9.4	1,142	2,010	2,694	
5	12	12		29	1.5	3.5	3.5	-	17,280	5.1	28,800	8.4	32,000	9.4	1,142	2,010	2,694	
7	7	15		29	2.0	2.0	4.4	-	17,280	5.1	28,800	8.4	32,000	9.4	1,142	2,010	2,694	
5	7	18		30	1.4	2.0	5.1	-	17,280	5.1	28,800	8.4	32,000	9.4	1,142	2,010	2,694	
9	9	12		30	2.5	2.5	3.4	-	17,280	5.1	28,800	8.4	32,000	9.4	1,142	2,010	2,694	
7	9	15		31	1.9	2.5	4.1	-	17,280	5.1	28,800	8.4	32,000	9.4	1,142	2,010	2,694	
7	12	12		31	1.9	3.3	3.3	-	17,280	5.1	28,800	8.4	32,000	9.4	1,142	2,010	2,694	
5	12	15		32	1.3	3.2	4.0	-	17,280	5.1	28,800	8.4	32,000	9.4	1,142	2,010	2,694	
5	9	18		32	1.3	2.4	4.7	-	17,280	5.1	28,800	8.4	32,000	9.4	1,142	2,010	2,694	
7	7	18		32	1.8	1.8	4.7	-	17,280	5.1	28,800	8.4	32,000	9.4	1,142	2,010	2,694	
9	9	15		33	2.3	2.3	3.8	-	17,280	5.1	28,800	8.4	32,000	9.4	1,142	2,010	2,694	
9	12	12		33	2.3	3.1	3.1	-	17,280	5.1	28,800	8.4	32,000	9.4	1,142	2,010	2,694	
7	9	18		34	1.7	2.2	4.5	-	17,280	5.1	28,800	8.4	32,000	9.4	1,142	2,010	2,694	
7	12	15		34	1.7	3.0	3.7	-	17,280	5.1	28,800	8.4	32,000	9.4	1,142	2,010	2,694	
5	5	24		34	1.2	1.2	6.0	-	17,280	5.1	28,800	8.4	32,000	9.4	1,142	2,010	2,694	
5	12	18		35	1.2	2.9	4.3	-	17,280	5.1	28,800	8.4	32,000	9.4	1,142	2,010	2,694	
5	15	15		35	1.2	3.6	3.6	-	17,280	5.1	28,800	8.4	32,000	9.4	1,142	2,010	2,694	
5	7	24		36	1.2	1.6	5.6	-	17,280	5.1	28,800	8.4	32,000	9.4	1,142	2,010	2,694	
9	12	15		36	2.1	2.8	3.5	-	17,280	5.1	28,800	8.4	32,000	9.4	1,142	2,010	2,694	
12	12	12		36	2.8	2.8	2.8	-	17,280	5.1	28,800	8.4	32,000	9.4	1,142	2,010	2,694	
9	9	18		36	2.1	2.1	4.2	-	17,280	5.1	28,800	8.4	32,000	9.4	1,142	2,010	2,694	
7	12	18		37	1.6	2.7	4.1	-	17,280	5.1	28,800	8.4	32,000	9.4	1,142	2,010	2,694	
7	15	15		37	1.6	3.4	3.4	-	17,280	5.1	28,800	8.4	32,000	9.4	1,142	2,010	2,694	
5	9	24		38	1.1	2.0	5.3	-	17,280	5.1	28,800	8.4	32,000	9.4	1,142	2,010	2,694	
5	15	18		38	1.1	3.3	4.0	-	17,280	5.1	28,800	8.4	32,000	9.4	1,142	2,010	2,694	
7	7	24		38	1.6	1.6	5.3	-	17,280	5.1	28,800	8.4	32,000	9.4	1,142	2,010	2,694	
9	12	18		39	1.9	2.6	3.9	-	17,280	5.1	28,800	8.4	32,000	9.4	1,142	2,010	2,694	
9	15	15		39	1.9	3.2	3.2	-	17,280	5.1	28,800	8.4	32,000	9.4	1,142	2,010	2,694	
12	12	15		39	2.6	2.6	3.2	-	17,280	5.1	28,800	8.4	32,000	9.4	1,142	2,010	2,694	

Operation	Combination (kBtu/h)					Heating											
						Each Capacity (kW)				Total Capacity				Total Input (W)			
	UNIT-A	UNIT-B	UNIT-C	UNIT-D	Total	UNIT-A	UNIT-B	UNIT-C	UNIT-D	Min	Rated	Max	Min	Rated	Max		

COMBINATION TABLE

MU4R25 / MU4M25

Operation	Combination (kBtu/h)					Heating												
						Each Capacity (kW)				Total Capacity				Total Input (W)				
	UNIT-A	UNIT-B	UNIT-C	UNIT-D	Total	UNIT-A	UNIT-B	UNIT-C	UNIT-D	Min	Rated	Max	Min	Rated	Max			
1 UNIT	5				5	1.6	-	-	-	5,000	1.5	5,500	1.6	6325	1.9	610	610	747
	7				7	2.5	-	-	-	5,500	1.6	8,400	2.5	9660	2.8	610	665	862
	9				9	3.2	-	-	-	6,480	1.9	10,800	3.2	12420	3.6	610	864	1,126
	12				12	3.9	-	-	-	7,920	2.3	13,200	3.9	15180	4.4	610	1,067	1,399
	15				15	4.8	-	-	-	9,900	2.9	16,500	4.8	18975	5.6	778	1,337	1,823
	18				18	5.8	-	-	-	11,880	3.5	19,800	5.8	22770	6.7	950	1,649	2,230
	24				24	7.4	-	-	-	15,240	4.5	25,400	7.4	26670	7.8	1,246	2,172	2,654
	5	5			10	1.8	1.8	-	-	7,200	2.1	12,000	3.5	14400	4.2	471	808	1,130
	5	7			12	1.8	2.5	-	-	8,640	2.5	14,400	4.2	17280	5.1	566	983	1,397
	5	9			14	1.8	3.2	-	-	10,080	3.0	16,800	4.9	20160	5.9	685	1,163	1,643
7	7			14	2.5	2.5	-	-	10,080	3.0	16,800	4.9	20160	5.9	685	1,163	1,643	
7	9			16	2.5	3.2	-	-	11,520	3.4	19,200	5.6	23040	6.8	783	1,348	1,928	
5	12			17	1.8	4.2	-	-	12,240	3.6	20,400	6.0	24480	7.2	832	1,456	2,057	
9	9			18	3.2	3.2	-	-	12,960	3.8	21,600	6.3	25920	7.6	882	1,537	2,189	
7	12			19	2.5	4.2	-	-	13,680	4.0	22,800	6.7	27360	8.0	932	1,648	2,323	
5	15			20	1.8	5.3	-	-	14,400	4.2	24,000	7.0	28800	8.4	983	1,732	2,459	
9	12			21	3.2	4.2	-	-	15,120	4.4	25,200	7.4	30240	8.9	1,034	1,846	2,644	
7	15			22	2.5	5.3	-	-	15,840	4.6	26,400	7.7	31680	9.3	1,085	1,932	2,877	
5	18			23	1.8	6.3	-	-	16,560	4.9	27,600	8.1	32000	9.4	1,163	2,049	2,955	
9	15			24	3.2	5.3	-	-	17,280	5.1	28,800	8.4	32000	9.4	1,215	2,138	2,955	
12	12			24	4.2	4.2	-	-	17,280	5.1	28,800	8.4	32000	9.4	1,215	2,138	2,955	
7	18			25	2.4	6.1	-	-	17,280	5.1	28,800	8.4	32000	9.4	1,215	2,138	2,955	
9	18			27	2.8	5.6	-	-	17,280	5.1	28,800	8.4	32000	9.4	1,215	2,138	2,955	
12	15			27	3.8	4.7	-	-	17,280	5.1	28,800	8.4	32000	9.4	1,215	2,138	2,955	
5	24			29	1.5	7.0	-	-	17,280	5.1	28,800	8.4	32000	9.4	1,215	2,138	2,955	
12	18			30	3.4	5.1	-	-	17,280	5.1	28,800	8.4	32000	9.4	1,215	2,138	2,955	
15	15			30	4.2	4.2	-	-	17,280	5.1	28,800	8.4	32000	9.4	1,215	2,138	2,955	
7	24			31	1.9	6.5	-	-	17,280	5.1	28,800	8.4	32000	9.4	1,215	2,138	2,955	
9	24			33	2.3	6.1	-	-	17,280	5.1	28,800	8.4	32000	9.4	1,215	2,138	2,955	
15	18			33	3.8	4.6	-	-	17,280	5.1	28,800	8.4	32000	9.4	1,215	2,138	2,955	
18	18			36	4.2	4.2	-	-	17,280	5.1	28,800	8.4	32000	9.4	1,215	2,138	2,955	
12	24			36	2.8	5.6	-	-	17,280	5.1	28,800	8.4	32000	9.4	1,215	2,138	2,955	
5	5	5		15	1.8	1.8	1.8	-	10,800	3.2	18,000	5.3	21600	6.3	690	1,192	1,662	
5	5	7		17	1.8	1.8	2.5	-	12,240	3.6	20,400	6.0	24480	7.2	782	1,368	1,934	
5	5	9		19	1.8	1.8	3.2	-	13,680	4.0	22,800	6.7	27360	8.0	876	1,549	2,183	
5	7	7		19	1.8	2.5	2.5	-	13,680	4.0	22,800	6.7	27360	8.0	876	1,549	2,183	
5	7	9		21	1.8	2.5	3.2	-	15,120	4.4	25,200	7.4	30240	8.9	972	1,735	2,486	
7	7	7		21	2.5	2.5	2.5	-	15,120	4.4	25,200	7.4	30240	8.9	972	1,735	2,486	
5	5	12		22	1.8	1.8	4.2	-	15,840	4.6	26,400	7.7	31680	9.3	1,020	1,817	2,650	
5	9	9		23	1.8	3.2	3.2	-	16,560	4.9	27,600	8.1	32000	9.4	1,093	1,926	2,694	
7	7	9		23	2.5	2.5	3.2	-	16,560	4.9	27,600	8.1	32000	9.4	1,093	1,926	2,694	
5	7	12		24	1.8	2.5	4.2	-	17,280	5.1	28,800	8.4	32000	9.4	1,142	2,010	2,694	
5	5	15		25	1.7	1.7	5.1	-	17,280	5.1	28,800	8.4	32000	9.4	1,142	2,010	2,694	
7	9	9		25	2.4	3.0	3.0	-	17,280	5.1	28,800	8.4	32000	9.4	1,142	2,010	2,694	
5	9	12		26	1.6	2.9	3.9	-	17,280	5.1	28,800	8.4	32000	9.4	1,142	2,010	2,694	
7	7	12		26	2.3	2.3	3.9	-	17,280	5.1	28,800	8.4	32000	9.4	1,142	2,010	2,694	
5	7	15		27	1.6	2.2	4.7	-	17,280	5.1	28,800	8.4	32000	9.4	1,142	2,010	2,694	
9	9	9		27	2.8	2.8	2.8	-	17,280	5.1	28,800	8.4	32000	9.4	1,142	2,010	2,694	
7	9	12		28	2.1	2.7	3.6	-	17,280	5.1	28,800	8.4	32000	9.4	1,142	2,010	2,694	
5	5	18		28	1.5	1.5	5.4	-	17,280	5.1	28,800	8.4	32000	9.4	1,142	2,010	2,694	
5	9	15		29	1.5	2.6	4.4	-	17,280	5.1	28,800	8.4	32000	9.4	1,142	2,010	2,694	
5	12	12		29	1.5	3.5	3.5	-	17,280	5.1	28,800	8.4	32000	9.4	1,142	2,010	2,694	
7	7	15		29	2.0	2.0	4.4	-	17,280	5.1	28,800	8.4	32000	9.4	1,142	2,010	2,694	
5	7	18		30	1.4	2.0	5.1	-	17,280	5.1	28,800	8.4	32000	9.4	1,142	2,010	2,694	
9	9	12		30	2.5	2.5	3.4	-	17,280	5.1	28,800	8.4	32000	9.4	1,142	2,010	2,694	
7	9	15		31	1.9	2.5	4.1	-	17,280	5.1	28,800	8.4	32000	9.4	1,142	2,010	2,694	
7	12	12		31	1.9	3.3	3.3	-	17,280	5.1	28,800	8.4	32000	9.4	1,142	2,010	2,694	
5	12	15		32	1.3	3.2	4.0	-	17,280	5.1	28,800	8.4	32000	9.4	1,142	2,010	2,694	
5	9	18		32	1.3	2.4	4.7	-	17,280	5.1	28,800	8.4	32000	9.4	1,142	2,010	2,694	
7	7	18		32	1.8	1.8	4.7	-	17,280	5.1	28,800	8.4	32000	9.4	1,142	2,010	2,694	
9	9	15		33	2.3	2.3	3.8	-	17,280	5.1	28,800	8.4	32000	9.4	1,142	2,010	2,694	
9	12	12		33	2.3	3.1	3.1	-	17,280	5.1	28,800	8.4	32000	9.4	1,142	2,010	2,694	
7	9	18		34	1.7	2.2	4.5	-	17,280	5.1	28,800	8.4	32000	9.4	1,142	2,010	2,694	
7	12	15		34	1.7	3.0	3.7	-	17,280	5.1	28,800	8.4	32000	9.4	1,142	2,010	2,694	
5	5	24		34	1.2	1.2	6.0	-	17,280	5.1	28,800	8.4	32000	9.4	1,142	2,010	2,694	
5	12	18		35	1.2	2.9	4.3	-	17,280	5.1	28,800	8.4	32000	9.4	1,142	2,010	2,694	
5	15	15		35	1.2	3.6	3.6	-	17,280	5.1	28,800	8.4	32000	9.4	1,142	2,010	2,694	
5	7	24		36	1.2	1.6	5.6	-	17,280	5.1	28,800	8.4	32000	9.4	1,142	2,010	2,694	
9	12	15		36	2.1	2.8	3.5	-	17,280	5.1	28,800	8.4	32000	9.4	1,142	2,010	2,694	
12	12	12		36	2.8	2.8	2.8	-	17,280	5.1	28,800	8.4	32000	9.4	1,142	2,010	2,694	
9	9	18		36	2.1	2.1	4.2	-	17,280	5.1	28,800	8.4	32000	9.4	1,142	2,010	2,694	
7	12	18		37	1.6	2.7	4.1	-	17,280	5.1	28,800	8.4	32000	9.4	1,142	2,010	2,694	
7	15	15		37	1.6	3.4	3.4	-	17,280	5.1	28,800	8.4	32000	9.4	1,142	2,010	2,694	
5	9	24		38	1.1	2.0	5.3	-	17,280	5.1	28,800	8.4	32000	9.4	1,142	2,010	2,694	
5	15	18		38	1.1	3.3	4.0	-	17,280	5.1	28,800	8.4	32000	9.4	1,142	2,010	2,694	
7	7	24		38	1.6	1.6	5.3	-	17,280	5.1	28,800	8.4	32000	9.4	1,142	2,010	2,694	
9	12	18		39	1.9	2.6	3.9	-	17,280	5.1	28,800	8.4	32000	9.4	1,142	2,010	2,694	
9	15	15		39	1.9	3.2	3.2	-	17,280	5.1	28,800	8.4	32000	9.4	1,142	2,010	2,694	
12	12	15		39	2.6	2.6	3.2	-	17,280	5.1	28,800	8.4	32000	9.4	1,142	2,010	2,694	

Operation	Combination (kBtu/h)					Heating											
						Each Capacity (kW)				Total Capacity				Total Input (W)			
	UNIT-A	UNIT-B	UNIT-C	UNIT-D	Total	UNIT-A	UNIT-B	UNIT-C	UNIT-D	Min	Rated	Max	Min	Rated	Max		
2 UNIT	5	5			10	1.6	-	-	-	5,000	1.5	5,5					

COMBINATION TABLE

MU4R27 / MU4M27

Operation	Combination (kBtu/h)					Cooling												
						Each Capacity (kW)				Total Capacity						Total Input (W)		
	UNIT-A	UNIT-B	UNIT-C	UNIT-D	Total	UNIT-A	UNIT-B	UNIT-C	UNIT-D	Min	Rated	Max	Min	Rated	Max			
1 UNIT	5				5	1.5	-	-	-	4,500	1.3	5,000	1.5	6,000	1.8	416	467	684
	7				7	2.1	-	-	-	4,800	1.4	7,000	2.1	8,400	2.5	416	551	741
	9				9	2.6	-	-	-	5,400	1.6	9,000	2.6	10,800	3.2	416	689	961
	12				12	3.5	-	-	-	7,200	2.1	12,000	3.5	14,400	4.2	551	944	1,287
	15				15	4.2	-	-	-	8,520	2.5	14,200	4.2	17,040	5.0	661	1,149	1,557
	18				18	5.3	-	-	-	10,800	3.2	18,000	5.3	21,600	6.3	858	1,482	2,013
	24				24	7.0	-	-	-	14,400	4.2	24,000	7.0	25,500	7.5	1,149	2,026	2,830
	5	5			10	1.5	1.5	-	-	6,000	1.8	10,000	2.9	12,000	3.5	423	696	952
	5	7			12	1.5	2.1	-	-	7,200	2.1	12,000	3.5	14,400	4.2	496	850	1,158
	5	9			14	1.5	2.6	-	-	8,400	2.5	14,000	4.1	16,800	4.9	595	1,008	1,370
2 UNIT	7	7			14	2.1	2.1	-	-	8,400	2.5	14,000	4.1	16,800	4.9	595	1,008	1,370
	7	9			16	2.1	2.6	-	-	9,600	2.8	16,000	4.7	19,200	5.6	670	1,169	1,588
	5	12			17	1.5	3.5	-	-	10,200	3.0	17,000	5.0	20,400	6.0	721	1,251	1,715
	9	9			18	2.6	2.6	-	-	10,800	3.2	18,000	5.3	21,600	6.3	772	1,334	1,812
	7	12			19	2.1	3.5	-	-	11,400	3.3	19,000	5.6	22,800	6.7	798	1,418	1,943
	5	15			20	1.5	4.4	-	-	12,000	3.5	20,000	5.9	24,000	7.0	850	1,503	2,042
	9	12			21	2.6	3.5	-	-	12,600	3.7	21,000	6.2	25,200	7.4	902	1,589	2,230
	7	15			22	2.1	4.4	-	-	13,200	3.9	22,000	6.4	26,400	7.7	955	1,647	2,376
	5	18			23	1.5	5.3	-	-	13,800	4.0	23,000	6.7	27,600	8.1	981	1,734	2,586
	9	15			24	2.6	4.4	-	-	14,400	4.2	24,000	7.0	28,800	8.4	1,034	1,823	2,756
	12	12			24	3.5	3.5	-	-	14,400	4.2	24,000	7.0	28,800	8.4	1,034	1,823	2,756
	7	18			25	2.1	5.3	-	-	15,000	4.4	25,000	7.3	30,000	8.8	1,088	1,948	2,993
	9	18			27	2.6	5.3	-	-	16,200	4.7	27,000	7.9	31,050	9.1	1,169	2,212	3,180
	12	15			27	3.5	4.4	-	-	16,200	4.7	27,000	7.9	31,050	9.1	1,169	2,212	3,180
	5	24			29	1.4	6.5	-	-	16,200	4.7	27,000	7.9	31,050	9.1	1,169	2,212	3,180
	12	18			30	3.2	4.7	-	-	16,200	4.7	27,000	7.9	31,050	9.1	1,169	2,212	3,180
	15	15			30	4.0	4.0	-	-	16,200	4.7	27,000	7.9	31,050	9.1	1,169	2,212	3,180
	7	24			31	1.8	6.1	-	-	16,200	4.7	27,000	7.9	31,050	9.1	1,169	2,212	3,180
	9	24			33	2.2	5.8	-	-	16,200	4.7	27,000	7.9	31,050	9.1	1,169	2,212	3,180
	15	18			33	3.6	4.3	-	-	16,200	4.7	27,000	7.9	31,050	9.1	1,169	2,212	3,180
	18	18			36	4.0	4.0	-	-	16,200	4.7	27,000	7.9	31,050	9.1	1,169	2,212	3,180
	12	24			36	2.6	5.3	-	-	16,200	4.7	27,000	7.9	31,050	9.1	1,169	2,212	3,180
	15	24			39	3.0	4.9	-	-	16,200	4.7	27,000	7.9	31,050	9.1	1,169	2,212	3,180
	5	5	5		15	1.5	1.5	1.5	-	9,000	2.6	15,000	4.4	18,000	5.3	583	1,023	1,405
	5	5	7		17	1.5	1.5	2.1	-	10,200	3.0	17,000	5.0	20,400	6.0	678	1,176	1,613
	5	5	9		19	1.5	1.5	2.6	-	11,400	3.3	19,000	5.6	22,800	6.7	750	1,333	1,826
	5	7	7		19	1.5	2.1	2.1	-	11,400	3.3	19,000	5.6	22,800	6.7	750	1,333	1,826
	5	7	9		21	1.5	2.1	2.6	-	12,600	3.7	21,000	6.2	25,200	7.4	848	1,494	2,096
	7	7	7		21	2.1	2.1	2.1	-	12,600	3.7	21,000	6.2	25,200	7.4	848	1,494	2,096
	5	5	12		22	1.5	1.5	3.5	-	13,200	3.9	22,000	6.4	26,400	7.7	897	1,548	2,234
	5	9	9		23	1.5	2.6	2.6	-	13,800	4.0	23,000	6.7	27,600	8.1	922	1,630	2,441
	7	7	9		23	2.1	2.1	2.6	-	13,800	4.0	23,000	6.7	27,600	8.1	922	1,630	2,441
	5	7	12		24	1.5	2.1	3.5	-	14,400	4.2	24,000	7.0	28,800	8.4	972	1,714	2,617
	5	5	15		25	1.5	1.5	4.4	-	15,000	4.4	25,000	7.3	30,000	8.8	1,023	1,831	2,865
	7	9	9		25	2.1	2.6	2.6	-	15,000	4.4	25,000	7.3	30,000	8.8	1,023	1,831	2,865
	5	9	12		26	1.5	2.6	3.5	-	15,600	4.6	26,000	7.6	31,200	9.1	1,073	1,953	3,063
	7	7	12		26	2.1	2.1	3.5	-	15,600	4.6	26,000	7.6	31,200	9.1	1,073	1,953	3,063
	5	7	15		27	1.5	2.1	4.4	-	16,200	4.7	27,000	7.9	31,050	9.1	1,099	2,079	3,063
	9	9	9		27	2.6	2.6	2.6	-	16,200	4.7	27,000	7.9	31,050	9.1	1,099	2,079	3,063
	7	9	12		28	2.0	2.5	3.4	-	16,200	4.7	27,000	7.9	31,050	9.1	1,099	2,079	3,063
5	5	18		28	1.4	1.4	5.1	-	16,200	4.7	27,000	7.9	31,050	9.1	1,099	2,079	3,063	
5	9	15		29	1.4	2.5	4.1	-	16,200	4.7	27,000	7.9	31,050	9.1	1,099	2,079	3,063	
5	12	12		29	1.4	3.3	3.3	-	16,200	4.7	27,000	7.9	31,050	9.1	1,099	2,079	3,063	
7	7	15		29	1.9	1.9	4.1	-	16,200	4.7	27,000	7.9	31,050	9.1	1,099	2,079	3,063	
5	7	18		30	1.3	1.8	4.7	-	16,200	4.7	27,000	7.9	31,050	9.1	1,099	2,079	3,063	
9	9	12		30	2.4	2.4	3.2	-	16,200	4.7	27,000	7.9	31,050	9.1	1,099	2,079	3,063	
7	9	15		31	1.8	2.3	3.8	-	16,200	4.7	27,000	7.9	31,050	9.1	1,099	2,079	3,063	
7	12	12		31	1.8	3.1	3.1	-	16,200	4.7	27,000	7.9	31,050	9.1	1,099	2,079	3,063	
5	12	15		32	1.2	3.0	3.7	-	16,200	4.7	27,000	7.9	31,050	9.1	1,099	2,079	3,063	
5	9	18		32	1.2	2.2	4.5	-	16,200	4.7	27,000	7.9	31,050	9.1	1,099	2,079	3,063	
7	7	18		32	1.7	1.7	4.5	-	16,200	4.7	27,000	7.9	31,050	9.1	1,099	2,079	3,063	
9	9	15		33	2.2	2.2	3.6	-	16,200	4.7	27,000	7.9	31,050	9.1	1,099	2,079	3,063	
5	12	12		33	2.2	2.9	2.9	-	16,200	4.7	27,000	7.9	31,050	9.1	1,099	2,079	3,063	
7	9	18		34	1.6	2.1	4.2	-	16,200	4.7	27,000	7.9	31,050	9.1	1,099	2,079	3,063	
7	12	15		34	1.6	2.8	3.5	-	16,200	4.7	27,000	7.9	31,050	9.1	1,099	2,079	3,063	
5	5	24		34	1.2	1.2	5.6	-	16,200	4.7	27,000	7.9	31,050	9.1	1,099	2,079	3,063	
5	12	18		35	1.1	2.7	4.1	-	16,200	4.7	27,000	7.9	31,050	9.1	1,099	2,079	3,063	
5	15	15		35	1.1	3.4	3.4	-	16,200	4.7	27,000	7.9	31,050	9.1	1,099	2,079	3,063	
5	7	24		36	1.1	1.5	5.3	-	16,200	4.7	27,000	7.9	31,050	9.1	1,099	2,079	3,063	
9	12	15		36	2.0	2.6	3.3	-	16,200	4.7	27,000	7.9	31,050	9.1	1,099	2,079	3,063	
12	12	12		36	2.6	2.6	2.6	-	16,200	4.7	27,000	7.9	31,050	9.1	1,099	2,079	3,063	
9	9	18		36	2.0	2.0	4.0	-	16,200	4.7	27,000	7.9	31,050	9.1	1,099	2,079	3,063	
7	12	18		37	1.5	2.6	3.8	-	16,200	4.7	27,000	7.9	31,050	9.1	1,099	2,079	3,063	
7	15	15		37	1.5	3.2	3.2	-	16,200	4.7	27,000	7.9	31,050	9.1	1,099	2,079	3,063	
5	9	24		38	1.0	1.9	5.0	-	16,200	4.7	27,000	7.9	31,050	9.1	1,099	2,079	3,063	
5	15	18		38	1.0	3.1	3.7	-	16,200	4.7	27,000	7.9	31,050	9.1	1,099	2,079	3,063	
7	7	24		38	1.5	1.5	5.0	-	16,200	4.7	27,000	7.9	31,050	9.1	1,099	2,		

COMBINATION TABLE

MU4R27 / MU4M27

Operation	Combination (kBtu/h)					Heating												
						Each Capacity (kW)				Total Capacity						Total Input (W)		
	UNIT-A	UNIT-B	UNIT-C	UNIT-D	Total	UNIT-A	UNIT-B	UNIT-C	UNIT-D	Btu/h	kW	Btu/h	kW	Btu/h	kW	Min	Rated	Max
1 UNIT	5				5	1.6	-	-	-	5,000	1.5	5,500	1.6	6,325	1.9	610	610	747
	7				7	2.5	-	-	-	5,400	1.6	8,400	2.5	9,660	2.8	610	665	862
	9				9	3.2	-	-	-	6,480	1.9	10,800	3.2	12,420	3.6	610	864	1,126
	12				12	3.9	-	-	-	7,920	2.3	13,200	3.9	15,180	4.4	610	1,067	1,399
	15				15	4.8	-	-	-	9,900	2.9	16,500	4.8	18,975	5.6	778	1,337	1,823
	18				18	5.8	-	-	-	11,880	3.5	19,800	5.8	22,770	6.7	950	1,649	2,230
	24				24	7.4	-	-	-	15,240	4.5	25,400	7.4	26,670	7.8	1,246	2,172	2,654
	5	5			10	1.8	1.8	-	-	7,200	2.1	12,000	3.5	14,400	4.2	471	808	1,130
	5	7			12	1.8	2.5	-	-	8,640	2.5	14,400	4.2	17,280	5.1	566	983	1,397
	5	9			14	1.8	3.2	-	-	10,080	3.0	16,800	4.9	20,160	5.9	685	1,163	1,643
2 UNIT	7	7			14	2.5	2.5	-	-	10,080	3.0	16,800	4.9	20,160	5.9	685	1,163	1,643
	7	9			16	2.5	3.2	-	-	11,520	3.4	19,200	5.6	23,040	6.8	783	1,348	1,928
	5	12			17	1.8	4.2	-	-	12,240	3.6	20,400	6.0	24,480	7.2	832	1,456	2,057
	9	9			18	3.2	3.2	-	-	12,960	3.8	21,600	6.3	25,920	7.6	882	1,537	2,189
	7	12			19	2.5	4.2	-	-	13,680	4.0	22,800	6.7	27,360	8.0	932	1,648	2,323
	5	15			20	1.8	5.3	-	-	14,400	4.2	24,000	7.0	28,800	8.4	983	1,732	2,459
	9	12			21	3.2	4.2	-	-	15,120	4.4	25,200	7.4	30,240	8.9	1,034	1,846	2,644
	7	15			22	2.5	5.3	-	-	15,840	4.6	26,400	7.7	31,680	9.3	1,085	1,932	2,877
	5	18			23	1.8	6.3	-	-	16,560	4.9	27,600	8.1	33,120	9.7	1,163	2,049	3,200
	9	15			24	3.2	5.3	-	-	17,280	5.1	28,800	8.4	34,100	10.0	1,228	2,138	3,463
	12	12			24	4.2	4.2	-	-	17,280	5.1	28,800	8.4	34,100	10.0	1,228	2,138	3,463
	7	18			25	2.5	6.3	-	-	18,000	5.3	30,000	8.8	34,100	10.0	1,280	2,267	3,463
	9	18			27	3.0	6.1	-	-	18,500	5.5	31,000	9.1	34,100	10.0	1,333	2,234	3,463
	12	15			27	4.0	5.0	-	-	18,500	5.5	31,000	9.1	34,100	10.0	1,333	2,234	3,463
	5	24			29	1.6	7.5	-	-	18,500	5.5	31,000	9.1	34,100	10.0	1,333	2,234	3,463
	12	18			30	3.6	5.5	-	-	18,500	5.5	31,000	9.1	34,100	10.0	1,333	2,234	3,463
	15	15			30	4.5	4.5	-	-	18,500	5.5	31,000	9.1	34,100	10.0	1,333	2,234	3,463
	7	24			31	2.1	7.0	-	-	18,500	5.5	31,000	9.1	34,100	10.0	1,333	2,234	3,463
	9	24			33	2.5	6.6	-	-	18,500	5.5	31,000	9.1	34,100	10.0	1,333	2,234	3,463
	15	18			33	4.1	5.0	-	-	18,500	5.5	31,000	9.1	34,100	10.0	1,333	2,234	3,463
	18	18			36	4.5	4.5	-	-	18,500	5.5	31,000	9.1	34,100	10.0	1,333	2,234	3,463
	12	24			36	3.0	6.1	-	-	18,500	5.5	31,000	9.1	34,100	10.0	1,333	2,234	3,463
	15	24			39	3.5	5.6	-	-	18,500	5.5	31,000	9.1	34,100	10.0	1,333	2,234	3,463
	5	5	5		15	1.8	1.8	1.8	-	10,800	3.2	18,000	5.3	21,600	6.3	690	1,192	1,662
	5	5	7		17	1.8	1.8	2.5	-	12,240	3.6	20,400	6.0	24,480	7.2	782	1,368	1,934
	5	5	9		19	1.8	1.8	3.2	-	13,680	4.0	22,800	6.7	27,360	8.0	876	1,549	2,183
	5	7	7		19	1.8	2.5	2.5	-	13,680	4.0	22,800	6.7	27,360	8.0	876	1,549	2,183
	5	7	9		21	1.8	2.5	3.2	-	15,120	4.4	25,200	7.4	30,240	8.9	972	1,735	2,486
	7	7	7		21	2.5	2.5	2.5	-	15,120	4.4	25,200	7.4	30,240	8.9	972	1,735	2,486
	5	5	12		22	1.8	1.8	4.2	-	15,840	4.6	26,400	7.7	31,680	9.3	1,020	1,817	2,650
5	9	9		23	1.8	3.2	3.2	-	16,560	4.9	27,600	8.1	33,120	9.7	1,093	1,926	2,831	
7	7	9		23	2.5	2.5	3.2	-	16,560	4.9	27,600	8.1	33,120	9.7	1,093	1,926	2,831	
5	7	12		24	1.8	2.5	4.2	-	17,280	5.1	28,800	8.4	34,560	10.1	1,142	2,010	3,020	
5	5	15		25	1.8	1.8	5.3	-	18,000	5.3	30,000	8.8	34,720	10.2	1,192	2,131	3,068	
7	9	9		25	2.5	3.2	3.2	-	18,000	5.3	30,000	8.8	34,720	10.2	1,192	2,131	3,068	
5	9	12		26	1.8	3.2	4.2	-	18,720	5.5	31,200	9.1	34,720	10.2	1,242	2,228	3,068	
7	7	12		26	2.5	2.5	4.2	-	18,720	5.5	31,200	9.1	34,720	10.2	1,242	2,228	3,068	
5	7	15		27	1.7	2.4	5.0	-	18,600	5.5	31,000	9.1	34,720	10.2	1,242	2,228	3,068	
9	9	9		27	3.0	3.0	3.0	-	18,600	5.5	31,000	9.1	34,720	10.2	1,242	2,228	3,068	
7	9	12		28	2.3	2.9	3.9	-	18,600	5.5	31,000	9.1	34,720	10.2	1,242	2,228	3,068	
5	5	18		28	1.6	1.6	5.8	-	18,600	5.5	31,000	9.1	34,720	10.2	1,242	2,228	3,068	
5	9	15		29	1.6	2.8	4.7	-	18,600	5.5	31,000	9.1	34,720	10.2	1,242	2,228	3,068	
5	12	12		29	1.6	3.8	3.8	-	18,600	5.5	31,000	9.1	34,720	10.2	1,242	2,228	3,068	
7	7	15		29	2.2	2.2	4.7	-	18,600	5.5	31,000	9.1	34,720	10.2	1,242	2,228	3,068	
5	7	18		30	1.5	2.1	5.5	-	18,600	5.5	31,000	9.1	34,720	10.2	1,242	2,228	3,068	
9	9	12		30	2.7	2.7	3.6	-	18,600	5.5	31,000	9.1	34,720	10.2	1,242	2,228	3,068	
7	9	15		31	2.1	2.6	4.4	-	18,600	5.5	31,000	9.1	34,720	10.2	1,242	2,228	3,068	
7	12	12		31	2.1	3.5	3.5	-	18,600	5.5	31,000	9.1	34,720	10.2	1,242	2,228	3,068	
5	12	15		32	1.4	3.4	4.3	-	18,600	5.5	31,000	9.1	34,720	10.2	1,242	2,228	3,068	
7	9	18		32	1.4	2.6	5.1	-	18,600	5.5	31,000	9.1	34,720	10.2	1,242	2,228	3,068	
7	7	18		32	2.0	2.0	5.1	-	18,600	5.5	31,000	9.1	34,720	10.2	1,242	2,228	3,068	
9	9	15		33	2.5	2.5	4.1	-	18,600	5.5	31,000	9.1	34,720	10.2	1,242	2,228	3,068	
9	12	12		33	2.5	3.3	3.3	-	18,600	5.5	31,000	9.1	34,720	10.2	1,242	2,228	3,068	
7	9	18		34	1.9	2.4	4.8	-	18,600	5.5	31,000	9.1	34,720	10.2	1,242	2,228	3,068	
7	12	15		34	1.9	3.2	4.0	-	18,600	5.5	31,000	9.1	34,720	10.2	1,242	2,228	3,068	
5	5	24		34	1.3	1.3	6.4	-	18,600	5.5	31,000	9.1	34,720	10.2	1,242	2,228	3,068	
5	12	18		35	1.3	3.1	4.7	-	18,600	5.5	31,000	9.1	34,720	10.2	1,242	2,228	3,068	
5	15	15		35	1.3	3.9	3.9	-	18,600	5.5	31,000	9.1	34,720	10.2	1,242	2,228	3,068	
5	7	24		36	1.3	1.8	6.1	-	18,600	5.5	31,000	9.1	34,720	10.2	1,242	2,228	3,068	
9	12	15		36	2.3	3.0	3.8	-	18,600	5.5	31,000	9.1	34,720	10.2	1,242	2,228	3,068	
12	12	12		36	3.0	3.0	3.0	-	18,600	5.5	31,000	9.1	34,720	10.2	1,242	2,228	3,068	
9	9	18		36	2.3	2.3	4.5	-	18,600	5.5	31,000	9.1	34,720	10.2	1,242	2,228	3,068	
7	12	18		37	1.7	2.9	4.4	-	18,600	5.5	31,000	9.1	34,720	10.2	1,242	2,228	3,068	
7	15	15		37	1.7	3.7	3.7	-	18,600	5.5	31,000	9.1	34,720	10.2	1,242	2,228	3,068	
5	9	24		38	1.2	2.2	5.7	-	18,600	5.5	31,000	9.1	34,720	10.2	1,242	2,228	3,068	
5	15	18		38	1.2	3.6	4.3	-	18,600	5.5	31,000	9.1	34,720	10.2	1,242	2,228	3,068	
7	7	24		38	1.7	1.7	5.7	-	18,600	5.5	31,000	9.1	34,720	10.2	1,242	2,228	3,068	
9	12	18		39	2.1	2.8	4.2	-	18,600	5.5	31,000	9.1	34,720	10.2	1,242	2,228	3,068	
9	15	15		39	2.1	3.5	3.5	-	18,600	5.5	31,000	9.1	34,720	10.2	1,242	2,228	3,068	
12	12	15		39	2.8	2.8	3.5	-	18,600	5.5	31,000	9.1	34,720	10.2	1,242	2,228	3,068	
7	9	24		40	1.6													

COMBINATION TABLE

MU5R30 / MU5M30

Operation	Combination (kBtu/h)						Cooling													
							Each Capacity (kW)					Total Capacity						Total Input (W)		
	UNIT-A	UNIT-B	UNIT-C	UNIT-D	UNIT-E	Total	UNIT-A	UNIT-B	UNIT-C	UNIT-D	UNIT-E	Min	Rated	Max	Min	Rated	Max			
1 UNIT	5					5	1.5	-	-	-	-	4,500	1.3	5,000	1.5	6,000	1.8	416	467	684
	7					7	2.1	-	-	-	-	4,800	1.4	7,000	2.1	8,400	2.5	416	551	741
	9					9	2.6	-	-	-	-	5,400	1.6	9,000	2.6	10,800	3.2	416	689	961
	12					12	3.5	-	-	-	-	7,200	2.1	12,000	3.5	14,400	4.2	551	944	1,287
	15					15	4.2	-	-	-	-	8,520	2.5	14,200	4.2	17,040	5.0	661	1,149	1,557
	18					18	5.3	-	-	-	-	10,800	3.2	18,000	5.3	21,600	6.3	858	1,482	2,013
	24					24	7.0	-	-	-	-	14,400	4.2	24,000	7.0	25,500	7.5	1,149	2,026	2,830
	5	5				10	1.5	1.5	-	-	-	6,000	1.8	10,000	2.9	12,000	3.5	423	696	952
	5	7				12	1.5	2.1	-	-	-	7,200	2.1	12,000	3.5	14,400	4.2	496	850	1,158
	5	9				14	1.5	2.6	-	-	-	8,400	2.5	14,000	4.1	16,800	4.9	595	1,008	1,370
2 UNIT	7	7				14	2.1	2.1	-	-	-	8,400	2.5	14,000	4.1	16,800	4.9	595	1,008	1,370
	7	9				16	2.1	2.6	-	-	-	9,600	2.8	16,000	4.7	19,200	5.6	670	1,169	1,588
	5	12				17	1.5	3.5	-	-	-	10,200	3.0	17,000	5.0	20,400	6.0	721	1,251	1,715
	9	9				18	2.6	2.6	-	-	-	10,800	3.2	18,000	5.3	21,600	6.3	772	1,334	1,812
	7	12				19	2.1	3.5	-	-	-	11,400	3.3	19,000	5.6	22,800	6.7	798	1,418	1,943
	5	15				20	1.5	4.4	-	-	-	12,000	3.5	20,000	5.9	24,000	7.0	850	1,503	2,042
	9	12				21	2.6	3.5	-	-	-	12,600	3.7	21,000	6.2	25,200	7.4	902	1,589	2,230
	7	15				22	2.1	4.4	-	-	-	13,200	3.9	22,000	6.4	26,400	7.7	955	1,647	2,376
	5	18				23	1.5	5.3	-	-	-	13,800	4.0	23,000	6.7	27,600	8.1	981	1,734	2,586
	9	15				24	2.6	4.4	-	-	-	14,400	4.2	24,000	7.0	28,800	8.4	1,034	1,823	2,756
3 UNIT	12	12				24	3.5	3.5	-	-	-	14,400	4.2	24,000	7.0	28,800	8.4	1,034	1,823	2,756
	7	18				25	2.1	5.3	-	-	-	15,000	4.4	25,000	7.3	30,000	8.8	1,088	1,948	2,993
	9	18				27	2.6	5.3	-	-	-	16,200	4.7	27,000	7.9	32,400	9.5	1,169	2,212	3,442
	12	15				27	3.5	4.4	-	-	-	16,200	4.7	27,000	7.9	32,400	9.5	1,169	2,212	3,442
	5	24				29	1.5	7.0	-	-	-	17,400	5.1	29,000	8.5	33,000	9.7	1,279	2,512	3,579
	12	18				30	3.5	5.3	-	-	-	18,000	5.3	30,000	8.8	33,000	9.7	1,334	2,672	3,579
	15	15				30	4.4	4.4	-	-	-	18,000	5.3	30,000	8.8	33,000	9.7	1,334	2,672	3,579
	7	24				31	2.0	6.8	-	-	-	18,000	5.3	30,000	8.8	33,000	9.7	1,334	2,672	3,579
	9	24				33	2.4	6.4	-	-	-	18,000	5.3	30,000	8.8	33,000	9.7	1,334	2,672	3,579
	15	18				33	4.0	4.8	-	-	-	18,000	5.3	30,000	8.8	33,000	9.7	1,334	2,672	3,579
4 UNIT	18	18				36	4.4	4.4	-	-	-	18,000	5.3	30,000	8.8	33,000	9.7	1,334	2,672	3,579
	12	24				36	2.9	5.9	-	-	-	18,000	5.3	30,000	8.8	33,000	9.7	1,334	2,672	3,579
	15	24				39	3.4	5.4	-	-	-	18,000	5.3	30,000	8.8	33,000	9.7	1,334	2,672	3,579
	18	24				42	3.8	5.0	-	-	-	18,000	5.3	30,000	8.8	33,000	9.7	1,334	2,672	3,579
	24	24				48	4.4	4.4	-	-	-	18,000	5.3	30,000	8.8	33,000	9.7	1,334	2,672	3,579
	5	5	5			15	1.5	1.5	1.5	-	-	9,000	2.6	15,000	4.4	18,000	5.3	583	1,023	1,405
	5	5	7			17	1.5	1.5	2.1	-	-	10,200	3.0	17,000	5.0	20,400	6.0	678	1,176	1,613
	5	5	9			19	1.5	1.5	2.6	-	-	11,400	3.3	19,000	5.6	22,800	6.7	750	1,333	1,826
	5	7	7			19	1.5	2.1	2.1	-	-	11,400	3.3	19,000	5.6	22,800	6.7	750	1,333	1,826
	5	7	9			21	1.5	2.1	2.6	-	-	12,600	3.7	21,000	6.2	25,200	7.4	848	1,494	2,096
5	7	12			21	1.5	2.1	2.1	-	-	12,600	3.7	21,000	6.2	25,200	7.4	848	1,494	2,096	
5	9	12			23	1.5	2.6	3.5	-	-	13,200	3.9	22,000	6.4	26,400	7.7	897	1,548	2,234	
5	9	9			23	1.5	2.6	2.6	-	-	13,800	4.0	23,000	6.7	27,600	8.1	922	1,630	2,441	
7	7	9			23	2.1	2.1	2.6	-	-	13,800	4.0	23,000	6.7	27,600	8.1	922	1,630	2,441	
5	7	12			24	1.5	2.1	3.5	-	-	14,400	4.2	24,000	7.0	28,800	8.4	972	1,714	2,617	
5	5	15			25	1.5	1.5	4.4	-	-	15,000	4.4	25,000	7.3	30,000	8.8	1,023	1,831	2,865	
7	9	9			25	2.1	2.6	2.6	-	-	15,000	4.4	25,000	7.3	30,000	8.8	1,023	1,831	2,865	
5	9	12			26	1.5	2.6	3.5	-	-	15,600	4.6	26,000	7.6	31,200	9.1	1,073	1,953	3,063	
7	7	12			26	2.1	2.1	3.5	-	-	15,600	4.6	26,000	7.6	31,200	9.1	1,073	1,953	3,063	
5	7	15			27	1.5	2.1	4.4	-	-	16,200	4.7	27,000	7.9	32,400	9.5	1,099	2,079	3,342	
9	9	9			27	2.6	2.6	2.6	-	-	16,200	4.7	27,000	7.9	32,400	9.5	1,099	2,079	3,342	
7	9	12			28	2.1	2.6	3.5	-	-	16,800	4.9	28,000	8.2	33,600	9.8	1,150	2,231	3,564	
5	5	18			28	1.5	1.5	5.3	-	-	16,800	4.9	28,000	8.2	33,600	9.8	1,150	2,231	3,564	
5	9	15			29	1.5	2.6	4.4	-	-	17,400	5.1	29,000	8.5	33,600	9.8	1,202	2,390	3,564	
5	12	12			29	1.5	3.5	3.5	-	-	17,400	5.1	29,000	8.5	33,600	9.8	1,202	2,390	3,564	
7	7	15			29	2.1	2.1	4.4	-	-	17,400	5.1	29,000	8.5	33,600	9.8	1,202	2,390	3,564	
5	7	18			30	1.5	2.1	5.3	-	-	18,000	5.3	30,000	8.8	33,600	9.8	1,254	2,558	3,564	
9	9	12			30	2.6	2.6	3.5	-	-	18,000	5.3	30,000	8.8	33,600	9.8	1,254	2,558	3,564	
7	9	15			31	2.0	2.6	4.3	-	-	18,000	5.3	30,000	8.8	33,600	9.8	1,254	2,558	3,564	
7	12	12			31	2.0	3.4	3.4	-	-	18,000	5.3	30,000	8.8	33,600	9.8	1,254	2,558	3,564	
5	12	15			32	1.4	3.3	4.1	-	-	18,000	5.3	30,000	8.8	33,600	9.8	1,254	2,558	3,564	
5	9	18			32	1.4	2.5	4.9	-	-	18,000	5.3	30,000	8.8	33,600	9.8	1,254	2,558	3,564	
7	7	18			32	1.9	1.9	4.9	-	-	18,000	5.3	30,000	8.8	33,600	9.8	1,254	2,558	3,564	
9	9	15			33	2.4	2.4	4.0	-	-	18,000	5.3	30,000	8.8	33,600	9.8	1,254	2,558	3,564	
9	12	12			33	2.4	3.2	3.2	-	-	18,000	5.3	30,000	8.8	33,600	9.8	1,254	2,558	3,564	
7	9	18			34	1.8	2.3	4.7	-	-	18,000	5.3	30,000	8.8	33,600	9.8	1,254	2,558	3,564	
5	5	24			34	1.3	1.3	6.2	-	-	18,000	5.3	30,000	8.8	33,600	9.8	1,254	2,558	3,564	
5	12	18			35	1.3	3.0	4.5	-	-	18,000	5.3	30,000	8.8	33,600	9.8	1,254	2,558	3,564	
5	15	15			35	1.3	3.8	3.8	-	-	18,000	5.3	30,000	8.8	33,600	9.8	1,254	2,558	3,564	
5	7	24			36	1.2	1.7	5.9	-	-	18,000	5.3	30,000	8.8	33,600	9.8	1,254	2,558	3,564	
9	12	15			36	2.2	2.9	3.7	-	-	18,000	5.3	30,000	8.8	33,600	9.8	1,254	2,558	3,564	
12	12	12			36	2.9	2.9	2.9	-	-	18,000	5.3	30,000	8.8	33,600	9.8	1,254	2,558	3,564	
9	9	18			36	2.2	2.2	4.4	-	-	18,000	5.3	30,000	8.8	33,600	9.8	1,254	2,558	3,564	
7	12	18			37	1.7	2.9	4.3	-	-	18,000	5.3	30,000	8.8	33,600	9.8	1,254	2,558	3,564	

COMBINATION TABLE

MU5R30 / MU5M30

Operation	Combination (kBtu/h)						Cooling													
							Each Capacity (kW)					Total Capacity					Total Input (W)			
	UNIT-A	UNIT-B	UNIT-C	UNIT-D	UNIT-E	Total	UNIT-A	UNIT-B	UNIT-C	UNIT-D	UNIT-E	Min	Rated	Max	Min	Rated	Max			
	5	5	5	5	5	25	1.5	1.5	1.5	1.5	1.5	15,000	4.4	25,000	7.3	30,000	8.8	949	1,711	2,527
	5	5	5	5	7	27	1.5	1.5	1.5	1.5	2.1	16,200	4.7	27,000	7.9	32,400	9.5	1,022	1,919	2,906
	5	5	5	5	9	29	1.5	1.5	1.5	1.5	2.6	17,400	5.1	29,000	8.5	34,800	10.2	1,120	2,141	3,324
	5	5	5	7	7	29	1.5	1.5	1.5	2.1	2.1	17,400	5.1	29,000	8.5	34,800	10.2	1,120	2,141	3,324
	5	5	5	7	9	31	1.4	1.4	1.4	2.0	2.6	18,000	5.3	30,000	8.8	36,000	10.6	1,170	2,256	3,582
	5	5	5	7	7	31	1.4	1.4	1.4	2.0	2.0	18,000	5.3	30,000	8.8	36,000	10.6	1,170	2,256	3,582
	5	5	5	5	12	32	1.4	1.4	1.4	1.4	3.3	18,000	5.3	30,000	8.8	36,000	10.6	1,170	2,256	3,582
	5	5	5	9	9	33	1.3	1.3	1.3	2.4	2.4	18,000	5.3	30,000	8.8	36,000	10.6	1,170	2,256	3,582
	5	5	7	7	9	33	1.3	1.3	1.3	1.9	2.4	18,000	5.3	30,000	8.8	36,000	10.6	1,170	2,256	3,582
	5	5	7	7	7	33	1.3	1.3	1.3	1.9	1.9	18,000	5.3	30,000	8.8	36,000	10.6	1,170	2,256	3,582
	5	5	5	7	12	34	1.3	1.3	1.3	1.8	3.1	18,000	5.3	30,000	8.8	36,000	10.6	1,170	2,256	3,582
	5	5	5	5	15	35	1.3	1.3	1.3	1.3	3.8	18,000	5.3	30,000	8.8	36,000	10.6	1,170	2,256	3,582
	5	7	7	7	9	35	1.3	1.3	1.3	1.8	2.3	18,000	5.3	30,000	8.8	36,000	10.6	1,170	2,256	3,582
	7	7	7	7	7	35	1.8	1.8	1.8	1.8	1.8	18,000	5.3	30,000	8.8	36,000	10.6	1,170	2,256	3,582
	5	5	5	9	12	36	1.2	1.2	1.2	1.2	2.9	18,000	5.3	30,000	8.8	36,000	10.6	1,170	2,256	3,582
	5	5	7	7	12	36	1.2	1.2	1.2	1.7	2.9	18,000	5.3	30,000	8.8	36,000	10.6	1,170	2,256	3,582
	5	5	5	7	15	37	1.2	1.2	1.2	1.2	3.6	18,000	5.3	30,000	8.8	36,000	10.6	1,170	2,256	3,582
	5	5	9	9	9	37	1.2	1.2	2.1	2.1	2.1	18,000	5.3	30,000	8.8	36,000	10.6	1,170	2,256	3,582
	5	7	7	9	9	37	1.2	1.2	1.7	2.1	2.1	18,000	5.3	30,000	8.8	36,000	10.6	1,170	2,256	3,582
	7	7	7	7	9	37	1.7	1.7	1.7	1.7	2.1	18,000	5.3	30,000	8.8	36,000	10.6	1,170	2,256	3,582
	5	5	5	5	18	38	1.2	1.2	1.2	1.2	4.2	18,000	5.3	30,000	8.8	36,000	10.6	1,170	2,256	3,582
	5	7	7	7	12	38	1.2	1.6	1.6	1.6	2.8	18,000	5.3	30,000	8.8	36,000	10.6	1,170	2,256	3,582
	5	5	5	9	15	39	1.1	1.1	1.1	2.0	3.4	18,000	5.3	30,000	8.8	36,000	10.6	1,170	2,256	3,582
	5	5	5	12	12	39	1.1	1.1	1.1	2.7	2.7	18,000	5.3	30,000	8.8	36,000	10.6	1,170	2,256	3,582
	5	5	7	7	15	39	1.1	1.1	1.6	1.6	3.4	18,000	5.3	30,000	8.8	36,000	10.6	1,170	2,256	3,582
	7	7	7	9	9	39	1.6	1.6	1.6	2.0	2.0	18,000	5.3	30,000	8.8	36,000	10.6	1,170	2,256	3,582
	5	7	9	9	9	39	1.1	1.6	2.0	2.0	2.0	18,000	5.3	30,000	8.8	36,000	10.6	1,170	2,256	3,582
	5	5	5	7	18	40	1.1	1.1	1.1	1.5	4.0	18,000	5.3	30,000	8.8	36,000	10.6	1,170	2,256	3,582
	5	5	9	9	12	40	1.1	1.1	2.0	2.0	2.6	18,000	5.3	30,000	8.8	36,000	10.6	1,170	2,256	3,582
	5	7	7	9	12	40	1.1	1.5	1.5	2.0	2.6	18,000	5.3	30,000	8.8	36,000	10.6	1,170	2,256	3,582
	7	7	7	7	12	40	1.5	1.5	1.5	1.5	2.6	18,000	5.3	30,000	8.8	36,000	10.6	1,170	2,256	3,582
	5	5	7	9	15	41	1.1	1.1	1.5	1.9	3.2	18,000	5.3	30,000	8.8	36,000	10.6	1,170	2,256	3,582
	5	7	7	7	15	41	1.1	1.5	1.5	1.5	3.2	18,000	5.3	30,000	8.8	36,000	10.6	1,170	2,256	3,582
	5	9	9	9	9	41	1.1	1.9	1.9	1.9	1.9	18,000	5.3	30,000	8.8	36,000	10.6	1,170	2,256	3,582
	7	7	9	9	9	41	1.5	1.5	1.9	1.9	1.9	18,000	5.3	30,000	8.8	36,000	10.6	1,170	2,256	3,582
	5	5	5	9	18	42	1.0	1.0	1.0	1.9	3.8	18,000	5.3	30,000	8.8	36,000	10.6	1,170	2,256	3,582
	5	5	5	12	15	42	1.0	1.0	1.0	2.5	3.1	18,000	5.3	30,000	8.8	36,000	10.6	1,170	2,256	3,582
	5	7	7	7	18	42	1.0	1.0	1.5	1.5	3.8	18,000	5.3	30,000	8.8	36,000	10.6	1,170	2,256	3,582
	5	7	9	9	12	42	1.0	1.5	1.9	1.9	2.5	18,000	5.3	30,000	8.8	36,000	10.6	1,170	2,256	3,582
	7	7	7	9	12	42	1.5	1.5	1.5	1.9	2.5	18,000	5.3	30,000	8.8	36,000	10.6	1,170	2,256	3,582
	5	5	9	9	15	43	1.0	1.0	1.8	1.8	3.1	18,000	5.3	30,000	8.8	36,000	10.6	1,170	2,256	3,582
	5	7	7	9	15	43	1.0	1.4	1.4	1.8	3.1	18,000	5.3	30,000	8.8	36,000	10.6	1,170	2,256	3,582
	5	7	7	12	12	43	1.0	1.4	1.4	2.5	2.5	18,000	5.3	30,000	8.8	36,000	10.6	1,170	2,256	3,582
	7	7	7	7	15	43	1.4	1.4	1.4	1.4	3.1	18,000	5.3	30,000	8.8	36,000	10.6	1,170	2,256	3,582
	7	9	9	9	9	43	1.4	1.8	1.8	1.8	1.8	18,000	5.3	30,000	8.8	36,000	10.6	1,170	2,256	3,582
	5	5	7	12	15	44	1.0	1.0	1.4	2.4	3.0	18,000	5.3	30,000	8.8	36,000	10.6	1,170	2,256	3,582
	5	5	5	5	24	44	1.0	1.0	1.0	1.0	4.8	18,000	5.3	30,000	8.8	36,000	10.6	1,170	2,256	3,582
	5	7	7	7	18	44	1.0	1.4	1.4	1.4	3.6	18,000	5.3	30,000	8.8	36,000	10.6	1,170	2,256	3,582
	5	9	9	9	12	44	1.0	1.8	1.8	1.8	2.4	18,000	5.3	30,000	8.8	36,000	10.6	1,170	2,256	3,582
	7	7	9	9	12	44	1.4	1.4	1.8	1.8	2.4	18,000	5.3	30,000	8.8	36,000	10.6	1,170	2,256	3,582
	5	5	5	12	18	45	1.0	1.0	1.0	2.3	3.5	18,000	5.3	30,000	8.8	36,000	10.6	1,170	2,256	3,582
	5	5	5	15	15	45	1.0	1.0	1.0	2.9	2.9	18,000	5.3	30,000	8.8	36,000	10.6	1,170	2,256	3,582
	5	7	9	9	15	45	1.0	1.4	1.8	1.8	2.9	18,000	5.3	30,000	8.8	36,000	10.6	1,170	2,256	3,582
	5	7	9	12	12	45	1.0	1.4	1.8	2.3	2.3	18,000	5.3	30,000	8.8	36,000	10.6	1,170	2,256	3,582
	7	7	7	9	15	45	1.4	1.4	1.4	1.8	2.9	18,000	5.3	30,000	8.8	36,000	10.6	1,170	2,256	3,582
	9	9	9	9	9	45	1.8	1.8	1.8	1.8	1.8	18,000	5.3	30,000	8.8	36,000	10.6	1,170	2,256	3,582
	5	5	5	7	24	46	1.0	1.0	1.0	1.3	4.6	18,000	5.3	30,000	8.8	36,000	10.6	1,170	2,256	3,582
	5	5	9	9	18	46	1.0	1.0	1.7	1.7	3.4	18,000	5.3	30,000	8.8	36,000	10.6	1,170	2,256	3,582
	5	5	9	12	15	46	1.0	1.0	1.7	2.3	2.9	18,000	5.3	30,000	8.8	36,000	10.6	1,170	2,256	3,582
	5	5	12	12	12	46	1.0	1.0	2.3	2.3	2.3	18,000	5.3	30,000	8.8	36,000	10.6	1,170	2,256	3,582
	5	7	7	9	18	46	1.0	1.3	1.3	1.7	3.4	18,000	5.3	30,000	8.8	36,000	10.6	1,170	2,256	3,582
	5	7	7	12	15	46	1.0	1.3	1.3	2.3	2.9	18,000	5.3	30,000	8.8	36,000	10.6	1,170	2,256	3,582
	7	7	7	7	18	46	1.3	1.3	1.3	1.3	3.4	18,000	5.3	30,000	8.8	36,000	10.6	1,170	2,256	3,582
	7	9	9	9	12	46	1.3	1.7	1.7	1.7	2.3	18,000	5.3	30,000	8.8	36,000	10.6	1,170	2,256	3,582
	5	5	7	15	15	47	0.9	0.9	1.3	2.8	2.8	18,000	5.3	30,000	8.8	36,000	10.6	1,170	2,256	3,582
	5	9	9	9	15	47	0.9	1.7	1.7	1.7	2.8	18,000	5.3	30,000	8.8	36,000	10.6	1,170	2,256	3,582
	5	9	9	12	12	47	0.9	1.7	1.7	2.2	2.2	18,000	5.3	30,000	8.8	36,000	10.6	1,170	2,256	3,582
	7	7	9	9	15	47	1.3	1.3	1.7	1.7	2.8	18,000	5.3	30,000	8.8	36,000	10.6	1,170	2,256	3,582
	7	7	9	12	12	47	1.3	1.3												

COMBINATION TABLE

MU5R30 / MU5M30

Operation	Combination (kBtu/h)						Heating													
							Each Capacity (kW)					Total Capacity					Total Input (W)			
	UNIT-A	UNIT-B	UNIT-C	UNIT-D	UNIT-E	Total	UNIT-A	UNIT-B	UNIT-C	UNIT-D	UNIT-E	Min	Rated	Max	Min	Rated	Max			
3 UNIT	7	18	18			43	1.6	4.2	4.2	-	-	20,700	6.1	34,500	10.1	38,640	11.3	1,394	2,626	3,686
	5	12	24			43	1.6	2.8	5.6	-	-	20,700	6.1	34,500	10.1	38,640	11.3	1,394	2,626	3,686
	5	15	24			44	1.1	3.4	5.5	-	-	20,700	6.1	34,500	10.1	38,640	11.3	1,394	2,626	3,686
	9	18	18			45	2.0	4.0	4.0	-	-	20,700	6.1	34,500	10.1	38,640	11.3	1,394	2,626	3,686
	9	12	24			45	2.0	2.7	5.4	-	-	20,700	6.1	34,500	10.1	38,640	11.3	1,394	2,626	3,686
	12	15	18			45	2.7	3.4	4.0	-	-	20,700	6.1	34,500	10.1	38,640	11.3	1,394	2,626	3,686
	15	15	15			45	3.4	3.4	3.4	-	-	20,700	6.1	34,500	10.1	38,640	11.3	1,394	2,626	3,686
	7	15	24			46	1.5	3.3	5.3	-	-	20,700	6.1	34,500	10.1	38,640	11.3	1,394	2,626	3,686
	5	18	24			47	1.1	3.9	5.2	-	-	20,700	6.1	34,500	10.1	38,640	11.3	1,394	2,626	3,686
	9	15	24			48	1.9	3.2	5.1	-	-	20,700	6.1	34,500	10.1	38,640	11.3	1,394	2,626	3,686
	12	18	18			48	2.5	3.8	3.8	-	-	20,700	6.1	34,500	10.1	38,640	11.3	1,394	2,626	3,686
	12	12	24			48	2.5	2.5	5.1	-	-	20,700	6.1	34,500	10.1	38,640	11.3	1,394	2,626	3,686
	15	15	18			48	3.2	3.2	3.8	-	-	20,700	6.1	34,500	10.1	38,640	11.3	1,394	2,626	3,686
	5	5	5	5		20	1.8	1.8	1.8	1.8	-	14,400	4.2	24,000	7.0	28,800	8.4	878	1,547	2,195
	5	5	5	7		22	1.8	1.8	1.8	2.5	-	15,840	4.6	26,400	7.7	31,680	9.3	969	1,726	2,527
	5	5	5	9		24	1.8	1.8	1.8	3.2	-	17,280	5.1	28,800	8.4	34,560	10.1	1,085	1,909	2,927
	5	5	7	7		24	1.8	1.8	2.5	2.5	-	17,280	5.1	28,800	8.4	34,560	10.1	1,085	1,909	2,927
	5	5	7	9		26	1.8	1.8	2.5	3.2	-	18,720	5.5	31,200	9.1	37,440	11.0	1,180	2,116	3,427
	5	7	7	7		26	1.8	2.5	2.5	2.5	-	18,720	5.5	31,200	9.1	37,440	11.0	1,180	2,116	3,427
	5	5	5	12		27	1.8	1.8	1.8	4.2	-	19,440	5.7	32,400	9.5	38,640	11.3	1,227	2,281	3,606
5	5	9	9		28	1.8	1.8	3.2	3.2	-	20,160	5.9	33,600	9.8	38,640	11.3	1,276	2,411	3,606	
5	7	7	9		28	1.8	2.5	2.5	3.2	-	20,160	5.9	33,600	9.8	38,640	11.3	1,276	2,411	3,606	
7	7	7	7		28	2.5	2.5	2.5	2.5	-	20,160	5.9	33,600	9.8	38,640	11.3	1,276	2,411	3,606	
5	5	7	12		29	1.7	1.7	2.4	4.2	-	20,700	6.1	34,500	10.1	38,640	11.3	1,324	2,545	3,606	
5	5	5	15		30	1.7	1.7	1.7	5.1	-	20,700	6.1	34,500	10.1	38,640	11.3	1,324	2,545	3,606	
5	7	9	9		30	1.7	2.4	3.0	3.0	-	20,700	6.1	34,500	10.1	38,640	11.3	1,324	2,545	3,606	
7	7	7	9		30	2.4	2.4	2.4	3.0	-	20,700	6.1	34,500	10.1	38,640	11.3	1,324	2,545	3,606	
5	5	9	12		31	1.6	1.6	2.9	3.9	-	20,700	6.1	34,500	10.1	38,640	11.3	1,324	2,545	3,606	
5	7	7	12		31	1.6	2.3	2.3	3.9	-	20,700	6.1	34,500	10.1	38,640	11.3	1,324	2,545	3,606	
5	5	7	15		32	1.6	1.6	2.2	4.7	-	20,700	6.1	34,500	10.1	38,640	11.3	1,324	2,545	3,606	
7	7	9	9		32	2.2	2.2	2.8	2.8	-	20,700	6.1	34,500	10.1	38,640	11.3	1,324	2,545	3,606	
5	9	9	9		32	1.6	2.8	2.8	2.8	-	20,700	6.1	34,500	10.1	38,640	11.3	1,324	2,545	3,606	
5	5	5	18		33	1.5	1.5	1.5	5.5	-	20,700	6.1	34,500	10.1	38,640	11.3	1,324	2,545	3,606	
5	7	9	12		33	1.5	2.1	2.8	3.7	-	20,700	6.1	34,500	10.1	38,640	11.3	1,324	2,545	3,606	
7	7	7	12		33	2.1	2.1	2.1	3.7	-	20,700	6.1	34,500	10.1	38,640	11.3	1,324	2,545	3,606	
5	5	9	15		34	1.5	1.5	2.7	4.5	-	20,700	6.1	34,500	10.1	38,640	11.3	1,324	2,545	3,606	
5	5	12	12		34	1.5	1.5	3.6	3.6	-	20,700	6.1	34,500	10.1	38,640	11.3	1,324	2,545	3,606	
5	7	7	15		34	1.5	2.1	2.1	4.5	-	20,700	6.1	34,500	10.1	38,640	11.3	1,324	2,545	3,606	
7	9	9	9		34	2.1	2.7	2.7	2.7	-	20,700	6.1	34,500	10.1	38,640	11.3	1,324	2,545	3,606	
5	5	7	18		35	1.4	1.4	2.0	5.2	-	20,700	6.1	34,500	10.1	38,640	11.3	1,324	2,545	3,606	
5	9	9	12		35	1.4	2.6	2.6	3.5	-	20,700	6.1	34,500	10.1	38,640	11.3	1,324	2,545	3,606	
7	7	9	12		35	2.0	2.0	2.6	3.5	-	20,700	6.1	34,500	10.1	38,640	11.3	1,324	2,545	3,606	
5	7	9	15		36	1.4	2.0	2.5	4.2	-	20,700	6.1	34,500	10.1	38,640	11.3	1,324	2,545	3,606	
5	7	12	12		36	1.4	2.0	3.4	3.4	-	20,700	6.1	34,500	10.1	38,640	11.3	1,324	2,545	3,606	
7	7	7	15		36	2.0	2.0	2.0	4.2	-	20,700	6.1	34,500	10.1	38,640	11.3	1,324	2,545	3,606	
9	9	9	9		36	2.5	2.5	2.5	2.5	-	20,700	6.1	34,500	10.1	38,640	11.3	1,324	2,545	3,606	
5	5	9	18		37	1.4	1.4	2.5	4.9	-	20,700	6.1	34,500	10.1	38,640	11.3	1,324	2,545	3,606	
5	5	12	15		37	1.4	1.4	3.3	4.1	-	20,700	6.1	34,500	10.1	38,640	11.3	1,324	2,545	3,606	
5	7	7	18		37	1.4	1.9	1.9	4.9	-	20,700	6.1	34,500	10.1	38,640	11.3	1,324	2,545	3,606	
7	9	9	12		37	1.9	2.5	2.5	3.3	-	20,700	6.1	34,500	10.1	38,640	11.3	1,324	2,545	3,606	
5	9	9	15		38	1.3	2.4	2.4	4.0	-	20,700	6.1	34,500	10.1	38,640	11.3	1,324	2,545	3,606	
7	7	9	15		38	1.9	1.9	2.4	4.0	-	20,700	6.1	34,500	10.1	38,640	11.3	1,324	2,545	3,606	
5	5	5	24		39	1.3	1.3	1.3	6.2	-	20,700	6.1	34,500	10.1	38,640	11.3	1,324	2,545	3,606	
5	7	9	18		39	1.3	1.8	2.3	4.7	-	20,700	6.1	34,500	10.1	38,640	11.3	1,324	2,545	3,606	
5	7	12	15		39	1.3	1.8	3.1	3.9	-	20,700	6.1	34,500	10.1	38,640	11.3	1,324	2,545	3,606	
9	9	9	12		39	2.3	2.3	2.3	3.1	-	20,700	6.1	34,500	10.1	38,640	11.3	1,324	2,545	3,606	
7	7	7	18		39	1.8	1.8	1.8	4.7	-	20,700	6.1	34,500	10.1	38,640	11.3	1,324	2,545	3,606	
5	5	12	18		40	1.3	1.3	3.0	4.6	-	20,700	6.1	34,500	10.1	38,640	11.3	1,324	2,545	3,606	
7	9	9	15		40	1.8	2.3	2.3	3.8	-	20,700	6.1	34,500	10.1	38,640	11.3	1,324	2,545	3,606	
5	9	12	12		40	1.8	2.3	3.0	3.0	-	20,700	6.1	34,500	10.1	38,640	11.3	1,324	2,545	3,606	
5	5	7	24		41	1.2	1.2	1.7	5.9	-	20,700	6.1	34,500	10.1	38,640	11.3	1,324	2,545	3,606	
5	9	12	15		41	1.2	2.2	3.0	3.7	-	20,700	6.1	34,500	10.1	38,640	11.3	1,324	2,545	3,606	
5	12	12	12		41	1.2	3.0	3.0	3.0	-	20,700	6.1	34,500	10.1	38,640	11.3	1,324	2,545	3,606	
7	7	12	15		41	1.7	1.7	3.0	3.7	-	20,700	6.1	34,500	10.1	38,640	11.3	1,324	2,545	3,606	
5	7	9	18		41	1.7	1.7	2.2	4.4	-	20,700	6.1	34,500	10.1	38,640	11.3	1,324	2,545	3,606	
9	9	15	15		42	1.2	1.7	3.6	3.6	-	20,700	6.1	34,500	10.1	38,640	11.3	1,324	2,545	3,606	
9	9	9	15		42	2.2	2.2	2.2	3.6	-	20,700	6.1	34,500	10.1	38,640	11.3	1,324	2,545	3,606	
7	9	12	12		42	2.2	2.2	2.9	2.9	-	20,700	6.1	34,500	10.1	38,640	11.3	1,324	2,545	3,606	
7	9	12	15		43	1.6	2.1	2.8	3.5	-	20,700	6.1	34,500	10.1	38,640	11.3	1,324	2,545	3,606	
7	12	12	12		43	1.6	2.8	2.8	2.8	-	20,700	6.1	34,500	10.1	38,640	11.				

COMBINATION TABLE

MU5M40

Operation	Combination (kBtu/h)						Cooling													
							Each Capacity (kW)					Total Capacity			Total Input (W)					
	UNIT-A	UNIT-B	UNIT-C	UNIT-D	UNIT-E	Total	UNIT-A	UNIT-B	UNIT-C	UNIT-D	UNIT-E	Min	Rated	Max	Min	Rated	Max			
1 UNIT	5	5					1.5					4,500	13	5,000	1.5	6,000	1.8	780	1,120	1,703
	7	7					2.1					4,800	1.4	7,000	2.1	8,400	2.5	780	1,120	1,703
	9	9					2.6					5,400	1.6	9,000	2.6	10,800	3.2	780	1,120	1,703
	12	12					3.5					7,200	2.1	12,000	3.5	14,400	4.2	780	1,120	1,703
	15	15					4.2					8,520	2.5	14,200	4.2	17,040	5.0	780	1,120	1,809
	18	18					5.3					10,800	3.2	18,000	5.3	21,600	6.3	800	1,260	1,915
	24	24					7.0					14,400	4.2	24,000	7.0	25,500	7.5	1,042	1,680	2,280
	5	5	5				1.5	1.5				6,000	1.8	10,000	2.9	12,000	3.5	780	1,120	1,703
	7	7	7				2.1	2.1				7,200	2.1	12,000	3.5	14,400	4.2	780	1,120	1,703
	9	9	9				2.6	2.6				8,400	2.5	14,000	4.1	16,800	4.9	780	1,120	1,703
	12	12	12				3.5	3.5				10,800	3.2	18,000	5.3	21,600	6.3	800	1,260	1,915
	2 UNITS	5	5	5				1.5	1.5				4,500	1.3	5,000	1.5	6,000	1.8	780	1,120
7		7	7				2.1	2.1				4,800	1.4	7,000	2.1	8,400	2.5	780	1,120	1,703
9		9	9				2.6	2.6				5,400	1.6	9,000	2.6	10,800	3.2	780	1,120	1,703
12		12	12				3.5	3.5				7,200	2.1	12,000	3.5	14,400	4.2	780	1,120	1,703
15		15	15				4.2	4.2				8,520	2.5	14,200	4.2	17,040	5.0	780	1,120	1,809
18		18	18				5.3	5.3				10,800	3.2	18,000	5.3	21,600	6.3	800	1,260	1,915
24		24	24				7.0	7.0				14,400	4.2	24,000	7.0	25,500	7.5	1,042	1,680	2,280
5		5	5	5			1.5	1.5	1.5			6,000	1.8	10,000	2.9	12,000	3.5	780	1,120	1,703
7		7	7	7			2.1	2.1	2.1			7,200	2.1	12,000	3.5	14,400	4.2	780	1,120	1,703
9		9	9	9			2.6	2.6	2.6			8,400	2.5	14,000	4.1	16,800	4.9	780	1,120	1,703
12		12	12	12			3.5	3.5	3.5			10,800	3.2	18,000	5.3	21,600	6.3	800	1,260	1,915
3 UNITS		5	5	5	5			1.5	1.5	1.5			4,500	1.3	5,000	1.5	6,000	1.8	780	1,120
	7	7	7	7			2.1	2.1	2.1			4,800	1.4	7,000	2.1	8,400	2.5	780	1,120	1,703
	9	9	9	9			2.6	2.6	2.6			5,400	1.6	9,000	2.6	10,800	3.2	780	1,120	1,703
	12	12	12	12			3.5	3.5	3.5			7,200	2.1	12,000	3.5	14,400	4.2	780	1,120	1,703
	15	15	15	15			4.2	4.2	4.2			8,520	2.5	14,200	4.2	17,040	5.0	780	1,120	1,809
	18	18	18	18			5.3	5.3	5.3			10,800	3.2	18,000	5.3	21,600	6.3	800	1,260	1,915
	24	24	24	24			7.0	7.0	7.0			14,400	4.2	24,000	7.0	25,500	7.5	1,042	1,680	2,280
	5	5	5	5	5		1.5	1.5	1.5	1.5		6,000	1.8	10,000	2.9	12,000	3.5	780	1,120	1,703
	7	7	7	7	7		2.1	2.1	2.1	2.1		7,200	2.1	12,000	3.5	14,400	4.2	780	1,120	1,703
	9	9	9	9	9		2.6	2.6	2.6	2.6		8,400	2.5	14,000	4.1	16,800	4.9	780	1,120	1,703
	12	12	12	12	12		3.5	3.5	3.5	3.5		10,800	3.2	18,000	5.3	21,600	6.3	800	1,260	1,915

Operation	Combination (kBtu/h)						Cooling													
							Each Capacity (kW)					Total Capacity			Total Input (W)					
	UNIT-A	UNIT-B	UNIT-C	UNIT-D	UNIT-E	Total	UNIT-A	UNIT-B	UNIT-C	UNIT-D	UNIT-E	Min	Rated	Max	Min	Rated	Max			
4 UNITS	5	5	5	5			1.5	1.5	1.5	1.5		12,000	3.5	20,000	5.9	24,000	7.0	868	1,400	2,128
	7	7	7	7			2.1	2.1	2.1	2.1		13,200	3.9	22,000	6.4	26,400	7.7	955	1,540	2,341
	9	9	9	9			2.6	2.6	2.6	2.6		14,400	4.2	24,000	7.0	28,800	8.4	1,042	1,680	2,554
	12	12	12	12			3.5	3.5	3.5	3.5		14,400	4.2	24,000	7.0	28,800	8.4	1,042	1,680	2,554
	15	15	15	15			4.2	4.2	4.2	4.2		15,600	4.6	26,000	7.6	31,200	9.1	1,128	1,820	2,767
	18	18	18	18			5.3	5.3	5.3	5.3		15,600	4.6	26,000	7.6	31,200	9.1	1,128	1,820	2,767
	24	24	24	24			7.0	7.0	7.0	7.0		16,200	4.7	27,000	7.9	32,400	9.5	1,172	1,890	2,873
	5	5	5	5	5		1.5	1.5	1.5	1.5	1.5	16,800	4.9	28,000	8.2	33,600	9.8	1,215	1,960	2,979
	7	7	7	7	7		2.1	2.1	2.1	2.1	2.1	16,800	4.9	28,000	8.2	33,600	9.8	1,215	1,960	2,979
	9	9	9	9	9		2.6	2.6	2.6	2.6	2.6	16,800	4.9	28,000	8.2	33,600	9.8	1,215	1,960	2,979
	12	12	12	12	12		3.5	3.5	3.5	3.5	3.5	16,800	4.9	28,000	8.2	33,600	9.8	1,215	1,960	2,979
	5 UNITS	5	5	5	5	5		1.5	1.5	1.5	1.5	1.5	17,400	5.1	29,000	8.5	34,800	10.2	1,259	2,030
7		7	7	7	7		2.1	2.1	2.1	2.1	2.1	17,400	5.1	29,000	8.5	34,800	10.2	1,259	2,030	3,086
9		9	9	9	9		2.6	2.6	2.6	2.6	2.6	17,400	5.1	29,000	8.5	34,800	10.2	1,259	2,030	3,086
12		12	12	12	12		3.5	3.5	3.5	3.5	3.5	17,400	5.1	29,000	8.5	34,800	10.2	1,259	2,030	3,086
15		15	15	15	15		4.2	4.2	4.2	4.2	4.2	18,000	5.3	30,000	8.8	36,000	10.6	1,302	2,100	3,192
18		18	18	18	18		5.3	5.3	5.3	5.3	5.3	18,000	5.3	30,000	8.8	36,000	10.6	1,302	2,100	3,192
24		24	24	24	24		7.0	7.0	7.0	7.0	7.0	18,000	5.3	30,000	8.8	36,000	10.6	1,302	2,100	3,192
5		5	5	5	5	5	1.5	1.5	1.5	1.5	1.5	18,000	5.3	30,000	8.8	36,000	10.6	1,302	2,100	3,192
7		7	7	7	7	7	2.1	2.1	2.1	2.1	2.1	18,000	5.3	30,000	8.8	36,000	10.6	1,302	2,100	3,192
9		9	9	9	9	9	2.6	2.6	2.6	2.6	2.6	18,000	5.3	30,000	8.8	36,000	10.6	1,302	2,100	3,192
12		12	12	12	12	12	3.5	3.5	3.5	3.5	3.5	18,000	5.3	30,000	8.8	36,000	10.6	1,302	2,100	3,192

COMBINATION TABLE

MU5M40

Operation	Combination (kBtu/h)						Heating									Total Input (W)				
							Each Capacity (kW)					Total Capacity								
	UNITA	UNITB	UNITC	UNITD	UNIT E	Total	UNIT-A	UNIT-B	UNIT-C	UNIT-D	UNIT-E	Min	Rated	Max	Min	Rated	Max			
4 UNITS	5	5	5	5	5	20	1.7	1.7	1.7	1.7	1.7	13,860	4.1	23,100	6.8	27,720	8.1	868	1,400	2,282
	5	5	5	5	7	22	1.7	1.7	1.7	2.4	-	15,180	4.4	25,300	7.4	30,360	8.9	955	1,540	2,510
	5	5	5	7	7	24	1.6	1.6	1.6	2.9	-	15,840	4.6	26,400	7.7	31,680	9.3	1,042	1,680	2,738
	5	5	7	7	7	24	1.6	1.6	2.2	2.2	-	15,840	4.6	26,400	7.7	31,680	9.3	1,042	1,680	2,738
	5	5	7	7	9	26	1.6	1.6	2.3	2.3	2.9	17,160	5.0	28,600	8.4	34,320	10.1	1,128	1,820	2,967
	5	5	7	7	9	26	1.6	1.6	2.3	2.3	2.3	17,160	5.0	28,600	8.4	34,320	10.1	1,128	1,820	2,967
	5	5	7	9	12	27	1.6	1.6	1.6	3.9	-	17,820	5.2	29,700	8.7	35,640	10.4	1,172	1,890	3,081
	5	5	9	9	12	28	1.6	1.6	2.9	2.9	-	18,480	5.4	30,800	9.0	36,960	10.8	1,215	1,960	3,195
	5	5	9	9	12	28	1.6	1.6	2.3	2.3	2.9	18,480	5.4	30,800	9.0	36,960	10.8	1,215	1,960	3,195
	5	5	9	12	15	28	1.6	1.6	2.3	2.3	2.3	18,480	5.4	30,800	9.0	36,960	10.8	1,215	1,960	3,195
	5	5	9	12	15	29	1.6	1.6	2.2	3.8	-	19,140	5.6	31,900	9.3	38,280	11.2	1,259	2,030	3,309
	5	5	9	12	15	29	1.6	1.6	2.3	2.3	2.9	19,140	5.6	31,900	9.3	38,280	11.2	1,259	2,030	3,309
	5	5	9	15	15	30	1.6	1.6	1.6	4.9	-	19,800	5.8	33,000	9.7	39,600	11.6	1,281	2,065	3,366
	5	5	9	15	15	30	1.6	1.6	2.3	2.9	2.9	19,800	5.8	33,000	9.7	39,600	11.6	1,281	2,065	3,366
	5	5	9	15	18	30	1.6	1.6	2.3	2.3	2.9	19,800	5.8	33,000	9.7	39,600	11.6	1,281	2,065	3,366
	5	5	9	15	18	31	1.6	1.6	2.9	3.9	-	20,460	6.0	34,100	10.0	40,920	12.0	1,345	2,170	3,537
	5	5	9	15	18	31	1.6	1.6	2.3	2.3	3.9	20,460	6.0	34,100	10.0	40,920	12.0	1,345	2,170	3,537
	5	5	9	15	21	32	1.6	1.6	2.3	2.9	2.9	21,120	6.2	35,200	10.3	42,240	12.4	1,367	2,205	3,594
	5	5	9	15	21	32	1.6	1.6	2.3	2.9	2.9	21,120	6.2	35,200	10.3	42,240	12.4	1,367	2,205	3,594
	5	5	9	18	18	32	1.6	2.9	2.9	2.9	2.9	21,120	6.2	35,200	10.3	42,240	12.4	1,367	2,205	3,594
	5	5	9	18	18	33	1.6	1.6	2.2	3.9	-	21,780	6.4	36,300	10.6	43,560	12.8	1,432	2,310	3,765
	5	5	9	18	18	33	1.6	1.6	2.2	2.9	3.9	21,780	6.4	36,300	10.6	43,560	12.8	1,432	2,310	3,765
	5	5	9	18	21	33	1.6	1.6	2.9	4.9	-	22,440	6.6	37,400	11.0	44,880	13.2	1,476	2,380	3,879
	5	5	9	18	21	33	1.6	1.6	2.3	2.3	4.9	22,440	6.6	37,400	11.0	44,880	13.2	1,476	2,380	3,879
	5	5	9	18	24	34	1.6	1.6	2.9	3.9	-	23,100	6.8	38,500	11.3	46,200	13.5	1,519	2,450	3,994
	5	5	9	18	24	34	1.6	1.6	2.3	2.3	3.9	23,100	6.8	38,500	11.3	46,200	13.5	1,519	2,450	3,994
	5	5	9	18	24	35	1.6	2.3	2.9	3.9	-	23,760	7.0	39,600	11.6	47,520	13.9	1,562	2,520	4,108
	5	5	9	18	24	35	1.6	2.3	2.3	2.3	3.9	23,760	7.0	39,600	11.6	47,520	13.9	1,562	2,520	4,108
	5	5	9	18	27	36	1.6	1.6	2.9	5.8	-	24,420	7.2	40,700	11.9	48,840	14.3	1,606	2,590	4,222
	5	5	9	18	27	36	1.6	1.6	2.3	2.3	5.8	24,420	7.2	40,700	11.9	48,840	14.3	1,606	2,590	4,222
	5	5	9	18	30	37	1.6	2.3	2.9	3.9	-	24,420	7.2	40,700	11.9	48,840	14.3	1,606	2,590	4,222
	5	5	9	18	30	37	1.6	2.3	2.3	2.3	3.9	24,420	7.2	40,700	11.9	48,840	14.3	1,606	2,590	4,222
	5	5	9	18	30	38	1.6	2.9	2.9	4.9	-	25,080	7.4	41,800	12.3	50,160	14.7	1,649	2,660	4,336
	5	5	9	18	30	38	1.6	2.3	2.3	2.9	4.9	25,080	7.4	41,800	12.3	50,160	14.7	1,649	2,660	4,336
	5	5	9	18	33	38	1.6	2.3	2.9	3.9	-	25,740	7.6	42,900	12.6	51,480	15.1	1,692	2,730	4,450
	5	5	9	18	33	38	1.6	2.3	2.3	2.9	3.9	25,740	7.6	42,900	12.6	51,480	15.1	1,692	2,730	4,450
	5	5	9	18	36	39	1.6	1.6	2.9	5.8	-	26,400	7.8	44,000	13.0	52,800	15.5	1,735	2,800	4,564
	5	5	9	18	36	39	1.6	1.6	2.3	2.3	5.8	26,400	7.8	44,000	13.0	52,800	15.5	1,735	2,800	4,564
	5	5	9	18	36	40	1.6	2.9	2.9	4.9	-	27,060	8.0	45,100	13.4	54,120	15.9	1,778	2,870	4,678
	5	5	9	18	36	40	1.6	2.3	2.9	3.9	4.9	27,060	8.0	45,100	13.4	54,120	15.9	1,778	2,870	4,678
5	5	9	18	39	41	1.6	1.6	2.9	5.8	-	27,720	8.2	46,200	13.8	55,440	16.3	1,820	2,940	4,792	
5	5	9	18	39	41	1.6	1.6	2.3	2.3	5.8	27,720	8.2	46,200	13.8	55,440	16.3	1,820	2,940	4,792	
5	5	9	18	42	42	1.6	2.3	2.9	4.9	-	28,380	8.4	47,300	14.2	56,760	16.7	1,862	3,010	4,906	
5	5	9	18	42	42	1.6	2.3	2.3	2.9	4.9	28,380	8.4	47,300	14.2	56,760	16.7	1,862	3,010	4,906	
5	5	9	18	45	43	1.6	2.9	2.9	4.9	-	29,040	8.6	48,400	14.6	58,080	17.1	1,904	3,080	5,020	
5	5	9	18	45	43	1.6	2.3	2.9	3.9	4.9	29,040	8.6	48,400	14.6	58,080	17.1	1,904	3,080	5,020	
5	5	9	18	48	44	1.6	1.6	2.9	5.8	-	29,700	8.8	49,500	15.0	59,400	17.5	1,946	3,150	5,134	
5	5	9	18	48	44	1.6	1.6	2.3	2.3	5.8	29,700	8.8	49,500	15.0	59,400	17.5	1,946	3,150	5,134	
5	5	9	18	48	45	1.6	2.3	2.9	4.9	-	30,360	9.0	50,600	15.4	60,720	17.9	1,988	3,220	5,248	
5	5	9	18	48	45	1.6	2.3	2.3	2.9	4.9	30,360	9.0	50,600	15.4	60,720	17.9	1,988	3,220	5,248	
5	5	9	18	51	46	1.6	1.6	2.9	5.8	-	31,020	9.2	51,700	15.8	62,040	18.3	2,030	3,290	5,362	
5	5	9	18	51	46	1.6	1.6	2.3	2.3	5.8	31,020	9.2	51,700	15.8	62,040	18.3	2,030	3,290	5,362	
5	5	9	18	54	47	1.6	2.3	2.9	4.9	-	31,680	9.4	52,800	16.2	63,360	18.7	2,072	3,360	5,476	
5	5	9	18	54	47	1.6	2.3	2.3	2.9	4.9	31,680	9.4	52,800	16.2	63,360	18.7	2,072	3,360	5,476	
5	5	9	18	57	48	1.6	2.9	2.9	4.9	-	32,340	9.6	53,900	16.6	64,680	19.1	2,114	3,430	5,590	
5	5	9	18	57	48	1.6	2.3	2.9	3.9	4.9	32,340	9.6	53,900	16.6	64,680	19.1	2,114	3,430	5,590	
5	5	9	18	60	49	1.6	1.6	2.9	5.8	-	33,000	9.8	55,000	17.0	66,000	19.5	2,156	3,500	5,704	
5	5	9	18	60	49	1.6	1.6	2.3	2.3	5.8	33,000	9.8	55,000	17.0	66,000	19.5	2,156	3,500	5,704	
5	5	9	18	63	50	1.6	2.3	2.9	4.9	-	33,660	10.0	56,100	17.4	67,320	19.9	2,198	3,570	5,818	
5	5	9	18	63	50	1.6	2.3	2.3	2.9	4.9	33,660	10.0	56,100	17.4	67,320	19.9	2,198	3,570	5,818	
5	5	9	18	66	51	1.6	1.6	2.9	5.8	-	34,320	10.2	57,200	17.8	68,640	20.3	2,240	3,640	5,932	
5	5	9	18	66	51	1.6	1.6	2.3	2.3	5.8	34,320	10.2	57,200	17.8	68,640	20.3	2,240	3,640	5,932	
5	5	9	18	69	52	1.6	2.3	2.9	4.9	-	34,980	10.4	58,300	18.2	69,960	20.7	2,282	3,710	6,046	
5	5	9	18	69	52	1.6	2.3	2.3	2.9	4.9	34,980	10.4	58,300	18.2	69,960	20.7	2,282	3,710	6,046	
5	5	9	18	72	53	1.6	2.9	2.9	4.9	-	35,640	10.6	59,400	18.6	71,280	21.1	2,324	3,780	6,160	
5	5	9	18	72	53	1.6	2.3	2.9	3.9	4.9	35,640	10.6	59,400	18.6	71,280	21.1	2,324	3,780	6,160	
5	5	9	18	75	54	1.6	1.6	2.9	5.8	-	36,300	10.8	60,500	19.0	72,600	21.5	2,366	3,850	6,274	
5	5	9	18	75	54	1.6	1.6	2.3	2.3	5.8	36,300	10.8	60,500	19.0	72,600	21				

COMMERCIAL

SINGLE SPLIT



SINGLE SPLIT

R32 LINE-UP



STANDARD INVERTER (R32)								
kBTu/h	Type kW	Ceiling Mounted Cassette	Ceiling Concealed Duct		Ceiling & Floor / Ceiling Suspended	Console / Wall Mounted / Floor Standing	ODU	
			Mid / High Static	Low Static			1Φ	3Φ
9	2.5	CT09R NR0		CL09R N20			UU09WR UL0	
12	3.5	CT12R NR0		CL12R N20			UU12WR UL0	
18	5.0	CT18R NQ0	CM18R N10	CL18R N20	UV18R N10		UU18WR U20	
24	7.1	CT24R NP0	CM24R N10	CL24R N30	UV24R N10		UU24WR U40	
30	8.0	UT30R NP0	UM30R N10		UV30R N10		UU30WR U40	
36	10.0	UT36R NM0	UM36R N20		UV36R N20		UU36WR U30	UU37WR U30
42	12.5	UT42R NM0	UM42R N20		UV42R N20		UU42WR U30	UU43WR U30
48	14.0	UT48R NM0	UM48R N30		UV48R N20		UU48WR U30	UU49WR U30
60	15.0	UT60R NM0	UM60R N30		UV60R N20		UU60WR U30	UU61WR U30
70	20.0							
85	25.0							

COMPACT INVERTER (R32)								
kBTu/h	Type kW	Ceiling Mounted Cassette	Ceiling Concealed Duct		Ceiling & Floor / Ceiling Suspended	Console / Wall Mounted / Floor Standing	ODU	
			Mid / High Static	Low Static			1Φ	3Φ
18	5.0		CM18R N10				UU18WCR UL0	
24	7.1		CM24R N10				UU24WCR U20	
30	8.0		UM30R N10				UU30WCR U40	
36	10.0		UM36R N20				UU36WCR U40	

SINGLE SPLIT

R410A LINE-UP

STANDARD INVERTER (R410A)								
kBTu/h	Type kW	Ceiling Mounted Cassette	Ceiling Concealed Duct		Ceiling & Floor / Ceiling Suspended	Console / Wall Mounted / Floor Standing	ODU	
			Mid / High Static	Low Static			1Φ	3Φ
9	2.5	CT09 NR2		CB09L N22	CV09 NE2	CQ09 NA0	UU09W UL0	
12	3.5	CT12 NR2		CB12L N22	CV12 NE2	CQ12 NA0	UU12W UL0	
18	5.0	CT18 NQ2	CM18 N14	CB18L N22		CQ18 NA0	UU18W UE4	
24	7.1	CT24 NP2	CM24 N14	CB24L N32			UU24W U44	
30	8.0	UT30 NP4	UM30 N14			UJ30 NV2	UU30W U44	
36	10.0	UT36 NN2	UM36 N24			UJ36 NV3	UU36W U02	UU37W U02
42	12.5	UT42 NM2	UM42 N24				UU42W U32	UU43W U32
48	14.0	UT48 NM2	UM48 N34			UP48 NT2	UU48W U32	UU49W U32
60	15.0	UT60 NM2	UM60 N34				UU60W U32	UU61W U32
70	20.0		UB70 N94					UU70W U34
85	25.0		UB85 N94					UU85W U74

COMPACT INVERTER (R410A)								
kBTu/h	Type kW	Ceiling Mounted Cassette	Ceiling Concealed Duct		Ceiling & Floor / Ceiling Suspended	Console / Wall Mounted / Floor Standing	ODU	
			Mid / High Static	Low Static			1Φ	3Φ
18	5.0		UB18C NH0				UU18WC UL0	
24	7.1		UB24C NH0				UU24WC UE0	
30	8.0		UM30 N14				UU30WC UE0	
36	10.0		UM36 N24				UU36WC U40	

COMMERCIAL

SINGLE SPLIT



FEATURE OVERVIEW

Category		STANDARD INVERTER (R32)									STANDARD INVERTER (R410A)								
kBTu/h		9	12	18	24	30	36	42	48	60	9	12	18	24	30	36	42	48	60
kW		2.5	3.5	5.0	7.1	8.0	10.0	12.5	14.0	15.0	2.5	3.5	5.0	7.1	8.0	10.0	12.5	14.0	15.0
Energy Efficiency	New Type Scroll Compressor						•	•	•	•									
	BLDC Comp. & Fan Motor	•	•	•	•	•	•	•	•	•	•	•	•	•	•	•	•	•	•
	Eurovent Certi.	•	•	•	•	•	•	•	•	•	•	•	•	•	•	•	•	•	•
	Variable Voltage Control			•	•	•	•	•	•	•			•	•	•	•	•	•	•
	Wide Louver Fin			•	•	•	•	•	•	•			•	•	•	•	•	•	•
	Optimised Heat Exchanger Path			•	•	•	•	•	•	•			•	•	•	•	•	•	•
	Power Saving Start up			•	•	•	•	•	•	•			•	•	•	•	•	•	•
	Quick Operation Response			•	•	•	•	•	•	•			•	•	•	•	•	•	•
	Peak Current Control			•	•	•							•	•	•				
	Mode Lock	•**	•**	•	•	•	•	•	•	•	•**	•**	•	•	•	•	•**	•**	•**
Standby Mode			•	•	•							•	•	•					
Durability	Ocean black fin heat exchanger	•	•	•	•	•	•	•	•	•									
Fast Cooling & Heating	Forced Cooling Operation			•	•	•	•	•	•	•			•	•	•	•	•	•	•
Comfort	Night Silent Operation			•	•	•	•	•	•	•			•	•	•	•	•	•	•
Smart	Outdoor Dry Contact						•	•	•	•						•	•	•	•
	LG MV	•	•	•	•	•	•	•	•	•	•	•	•	•	•	•	•	•	•
	Weekly Program*	•	•	•	•	•	•	•	•	•	•	•	•	•	•	•	•	•	•
	PI-485 Connection			•	•	•	•	•	•	•			•	•	•	•	•	•	•
	Wi-Fi Ready	•	•	•	•	•	•	•	•	•									
AHU Solution	Return Air Control			•	•	•	•	•	•	•			•	•	•	•	•	•	•
	0-10V Supply Air Control												•	•	•				

* Weekly program is available with wired remote controller
 ** With controller PREMTB001 / PREMTB01 / PREMTB100 / PREMTB10

Category		COMPACT (R32)				COMPACT (R410A)				STANDARD INVERTER (R410A)		
kBTu/h		18	24	30	36	18	24	30	36	70	85	
kW		5.0	7.1	8.0	10.0	5.0	7.1	8.0	10.0	20.0	25.0	
Energy Efficiency	New Type Scroll Compressor											
	BLDC Comp. & Fan Motor	•	•	•	•	•	•	•	•	•	•	
	Eurovent Certi.	•	•	•	•	•	•	•	•	•	•	
	Variable Voltage Control										•	•
	Wide Louver Fin	•	•		•	•	•		•	•	•	•
	Optimised Heat Exchanger Path	•	•	•	•	•	•	•	•	•	•	•
	Power Saving Start up	•	•	•	•	•	•	•	•	•	•	•
	Quick Operation Response	•	•	•	•	•	•	•	•	•	•	•
	Peak Current Control										•	•
	Mode Lock	•	•	•	•	•	•	•	•	•	•	•
Standby Mode	•	•	•	•	•	•	•	•	•	•	•	
Durability	Ocean black fin heat exchanger											
Fast Cooling & Heating	Forced Cooling Operation									•	•	
Comfort	Night Silent Operation									•	•	
Smart	Outdoor Dry Contact									•	•	
	LG MV	•	•	•	•	•	•	•	•	•	•	
	Weekly Program*	•**	•**	•	•	•**	•**	•	•	•	•	
	PI-485 Connection										•	•
	Wi-Fi Ready	•	•	•	•	•	•	•	•	•		
AHU Solution	Return Air Control	•	•	•	•	•	•	•	•	•	•	
	0-10V Supply Air Control									•	•	

* Weekly program is available with wired remote controller
 ** With controller PREMTB001 / PREMTB01

ENERGY EFFICIENCY

New Type Scroll Compressor

(UU36WR, UU37WR, UU42WR, UU43WR, UU48WR, UU49WR, UU60WR, UU61WR)

Scroll + Rotary compressor

- Scroll compression + Rotary structure
- High efficiency (seasonal efficiency improvement)
- Low noise (high speed possible)
- Wide operating range (15~150Hz)

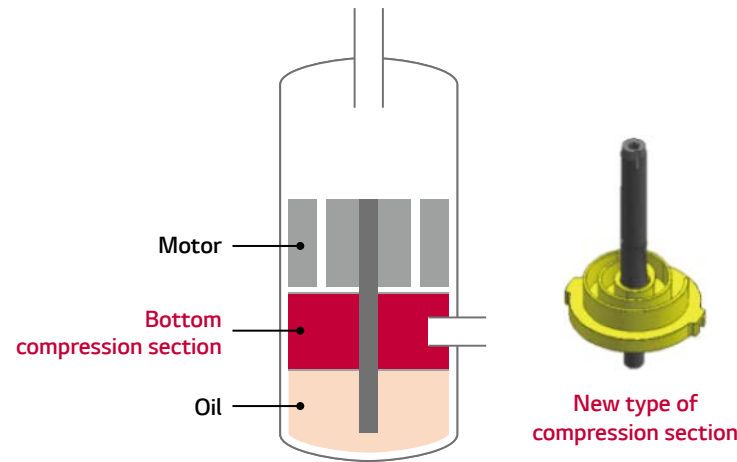

Seasonal energy efficiency

SEER 11.5%, SCOP 7.1% improvement (vs. rotary)

• LG Internal test result, Based on single split 1.2 kW

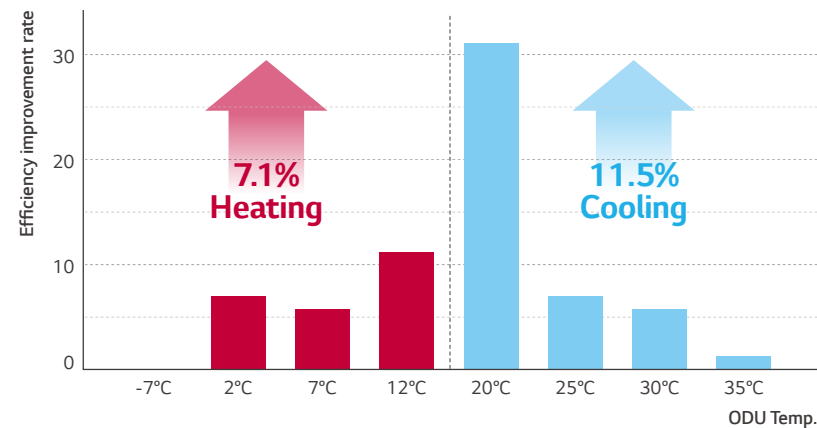

Wide Operation Range

- Optimized for various cooling & heat load operation
- World best compressor speed (up to 150 Hz)
- Optimized for even low load operation (down to 15 Hz)
(Efficiency increases / Improved comfort)

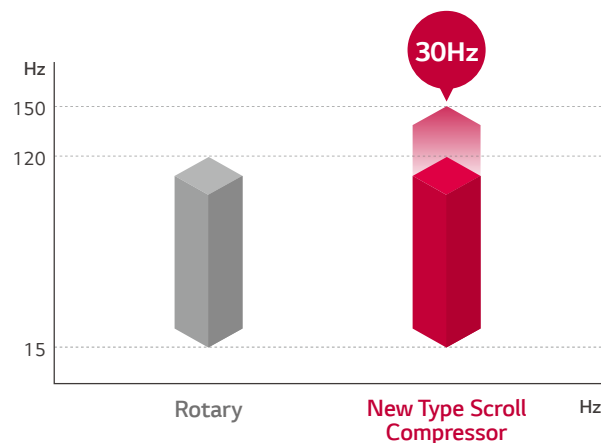

BLDC (Brushless Direct Current Motor) Compressor

LG air conditioners are equipped with a BLDC compressor that uses a strong neodymium magnet. The compressor has improved efficiency compared to standard AC inverter products and it is optimized for seasonal efficiency.

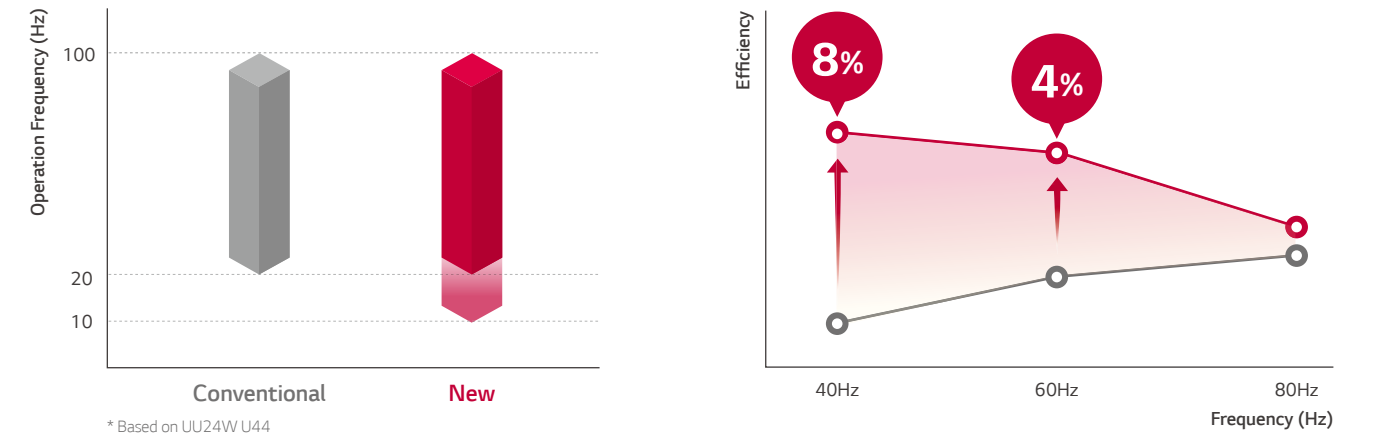

BLDC Fan Motor

The BLDC Fan motor is more efficient than a conventional AC motor, offering an additional 40% energy savings at low speeds and 20% at high speeds.

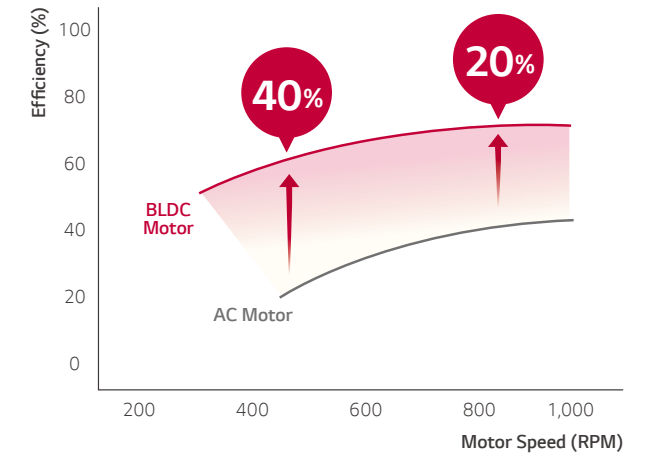

Variable Voltage Control

The compressor of Standard Inverter improves efficiency by adjusting the compressor input voltage depending upon the compressor input load.

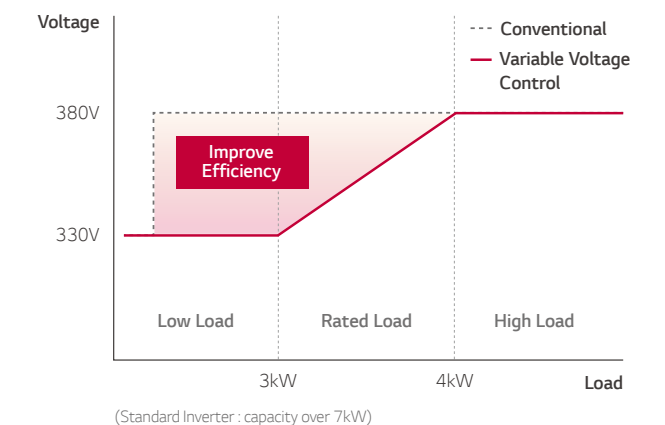

ENERGY EFFICIENCY

Wide Louver Plus Fin

Wide Louver Plus fin technology increases 11% of full load heating performance and 6% of COP compared to conventional fin. It can minimize frosting of the heat exchanger and delay the start of defrosting operation.

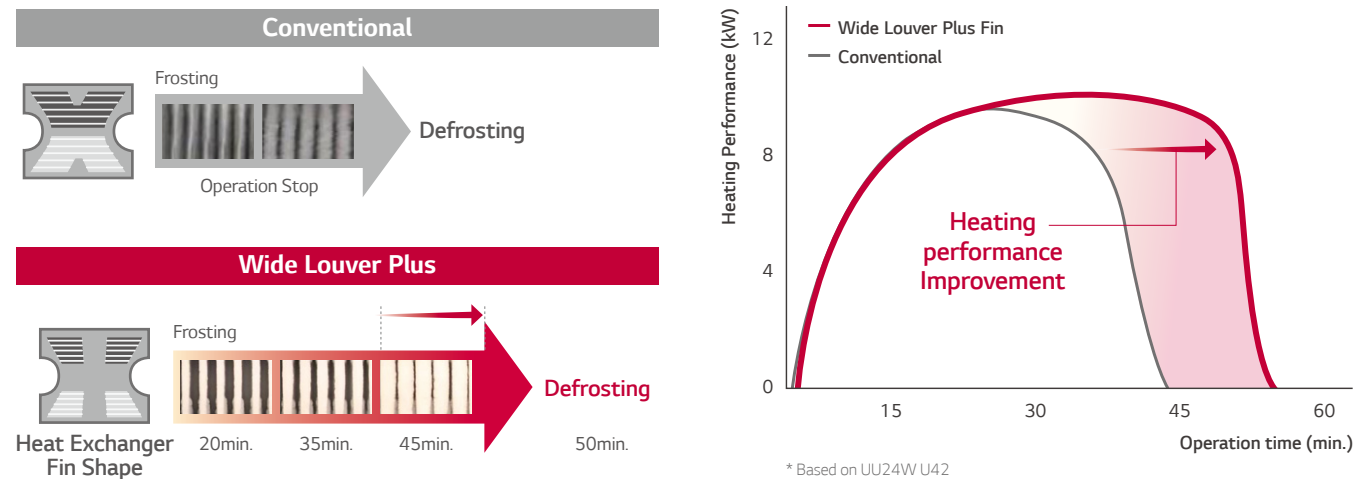

Optimised Heat Exchanger Path

Optimized heat exchanger path improves cycle efficiency up to 5%.

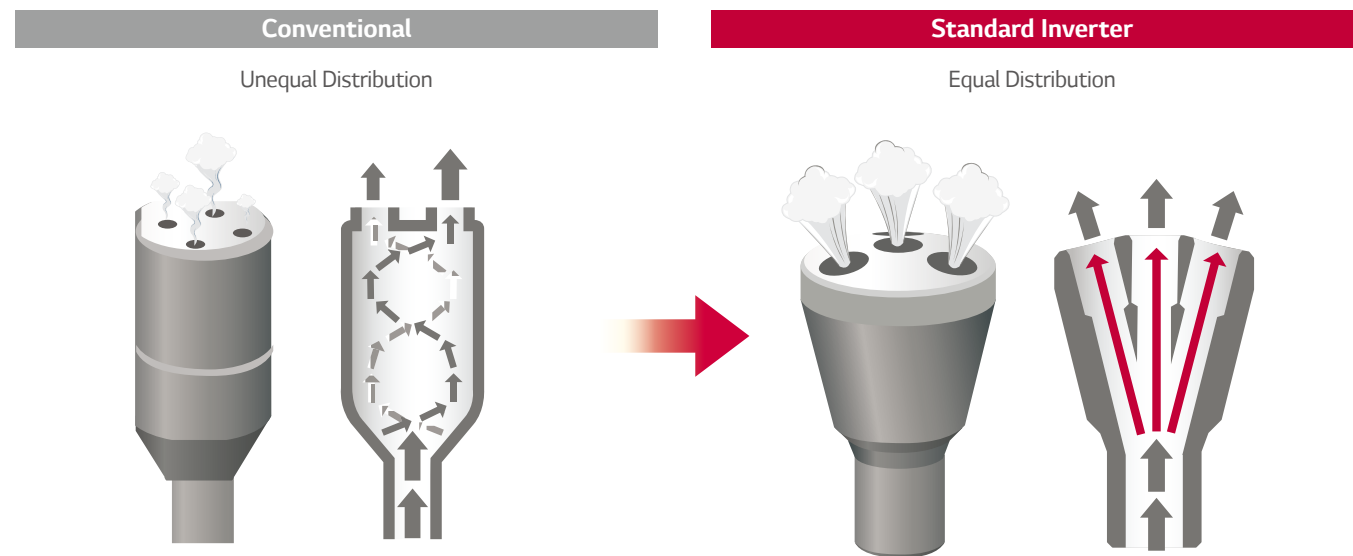

Power Saving Start Up

LG commercial air conditioners will automatically alter the temperature of discharge air by controlling their refrigerant temperature based on the difference between the indoor temperature and the target indoor temperature. During cooling operation, evaporating temperature will increase if the temperature difference reduces. This leads to extremely comfortable indoor air whilst minimizing energy consumption.

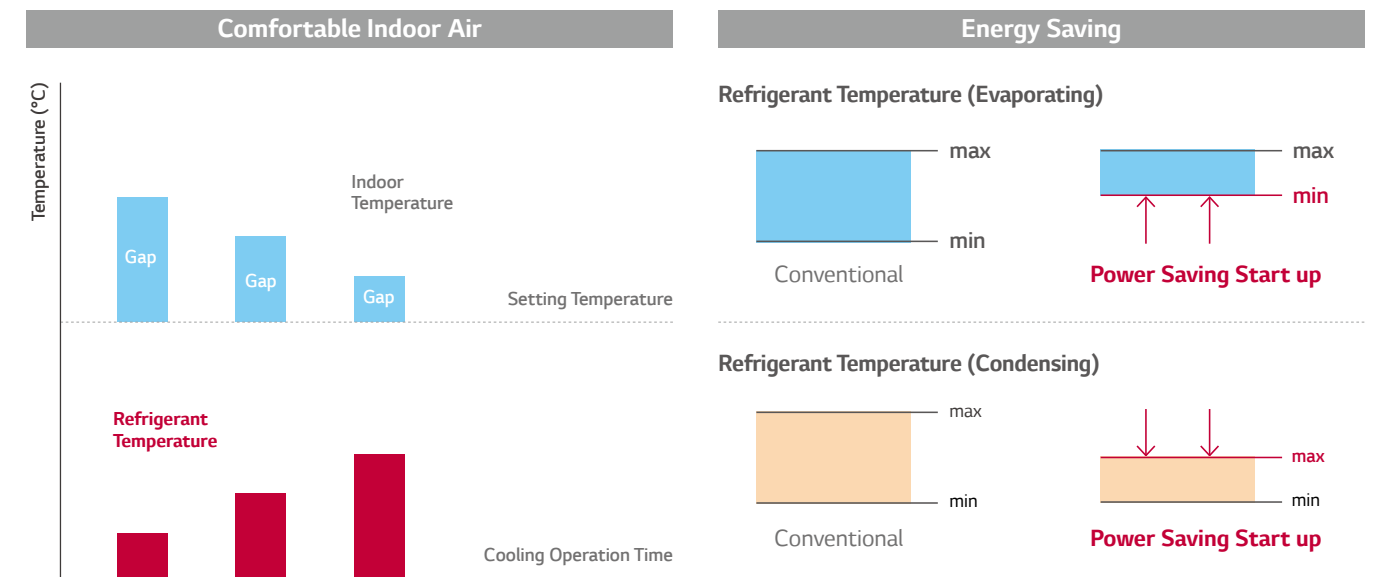

Quick Operating Response

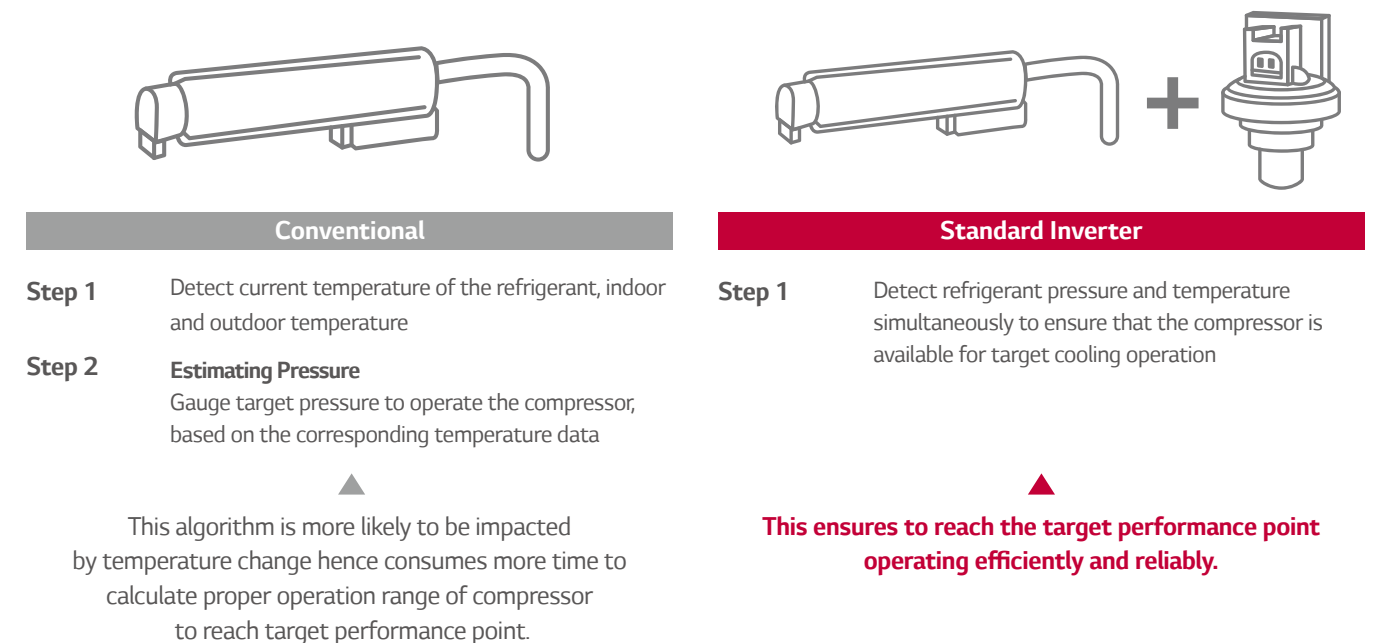

ENERGY EFFICIENCY

Peak Current Control

The peak current control function prevents the air conditioner from running at the maximum level while maintaining current system settings, in order to reduce energy consumption. This function helps minimize energy costs during the peak periods of energy use when the energy billing is much higher.

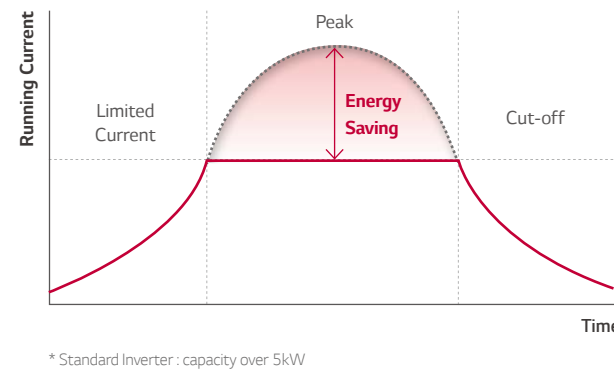

Mode Lock

Set the operation mode to either cooling-only or heating-only; either by adjusting the wired remote controller or setting the DIP switch to avoid combined use of cooling and heating. (Some models need wired remote controller for mode lock function according to feature overview table)

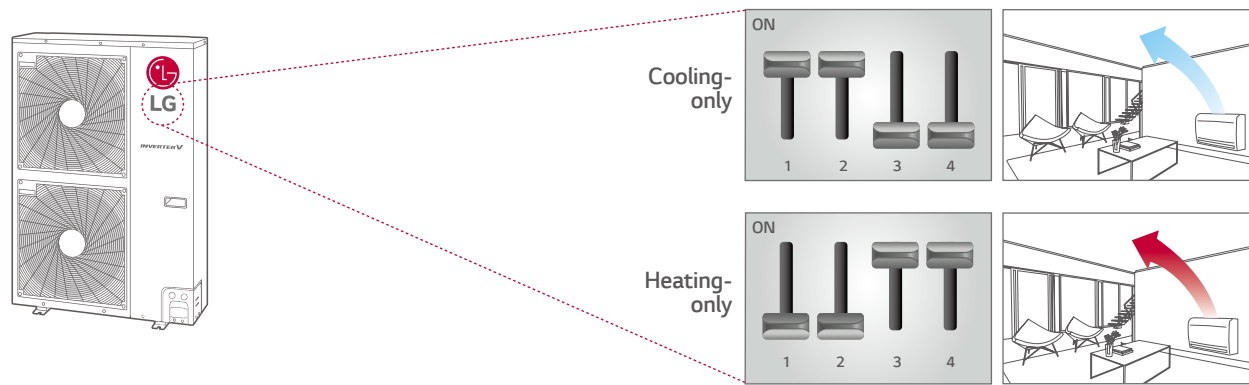

Standby Mode

Standard Inverter can minimise power consumption by turning power off on the PCB except for the MICOM which receives signals.

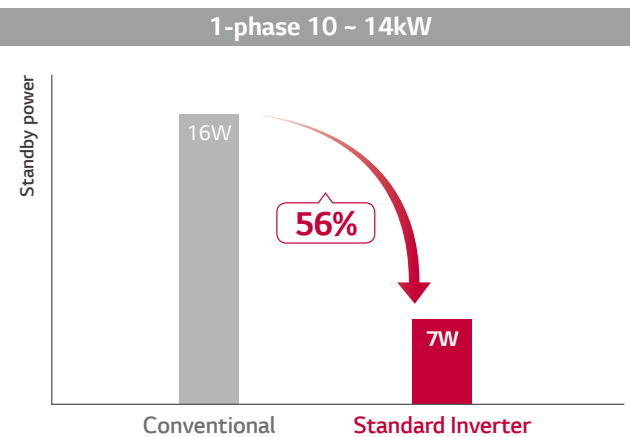

DURABILITY

Ocean Black Fin

LG's exclusive "Ocean Black Fin" heat exchanger is designed for Improved corrosion resistance.

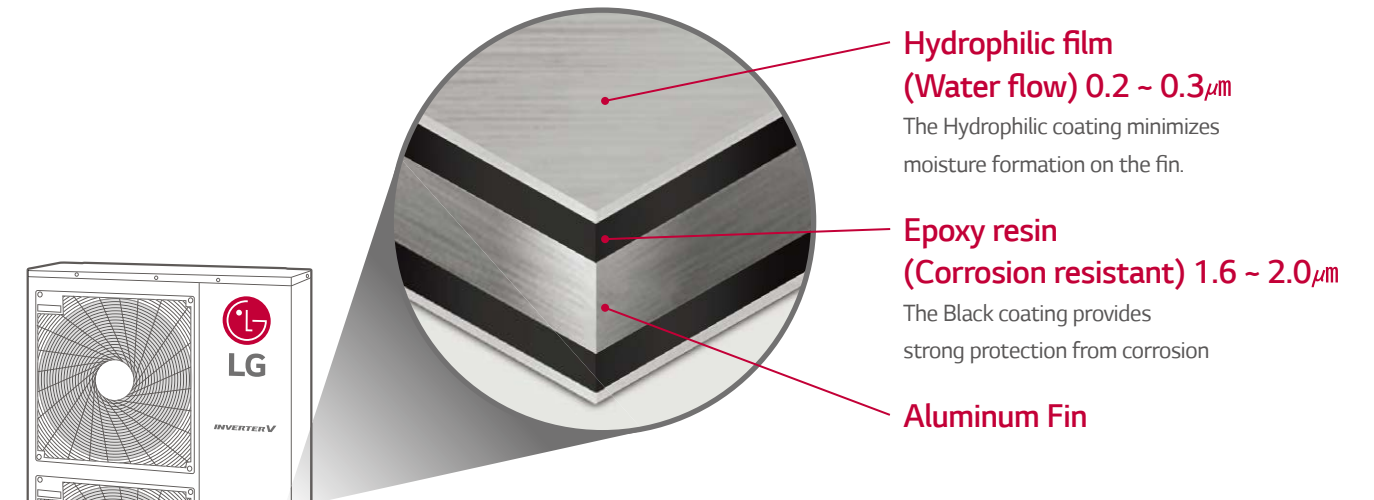

• Certified protection



- Test Method B of ISO21207, 6.2 & Annex A
- Test condition: Salt contaminated condition + severe industrial/traffic environment(NO₂/SO₂)

* Based on 1,500 UL test hours

FAST COOLING & HEATING

Forced Cooling Operation

This function allows the refrigerant to be recharged or pumped down, regardless of the indoor temperature. Note that this function can be used when indoor units are being moved or repaired.

Recharging

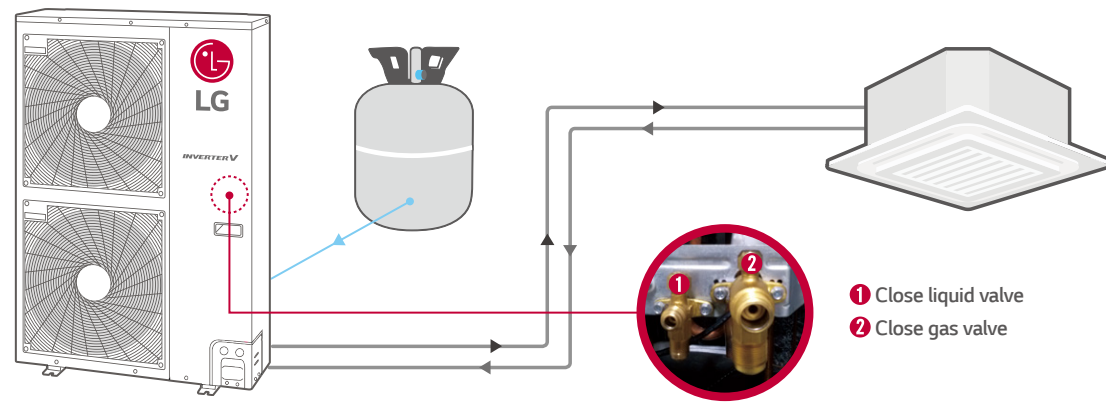

Pump Down

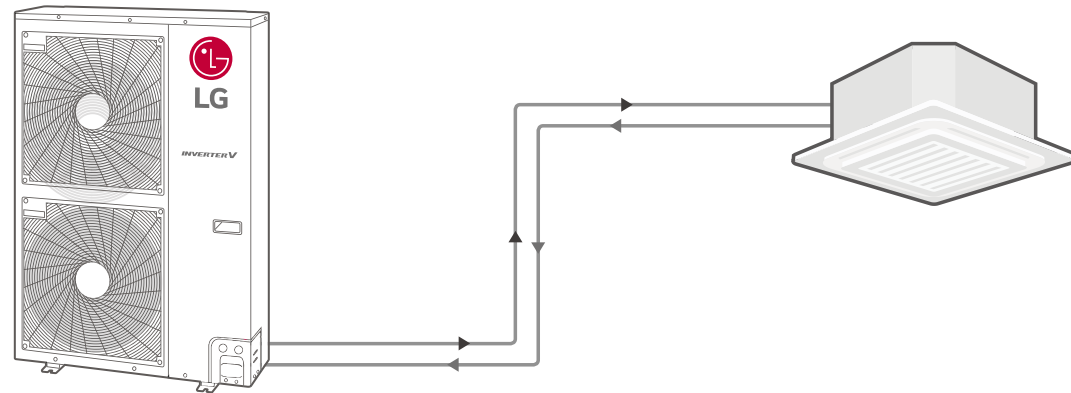

COMFORT

Night Silent Operation

This function enables noise reduction during night time by simply setting the dip switch on the PCB of the outdoor unit.

Cooling Mode

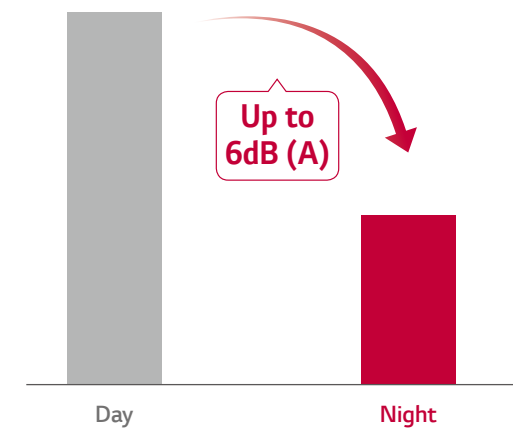
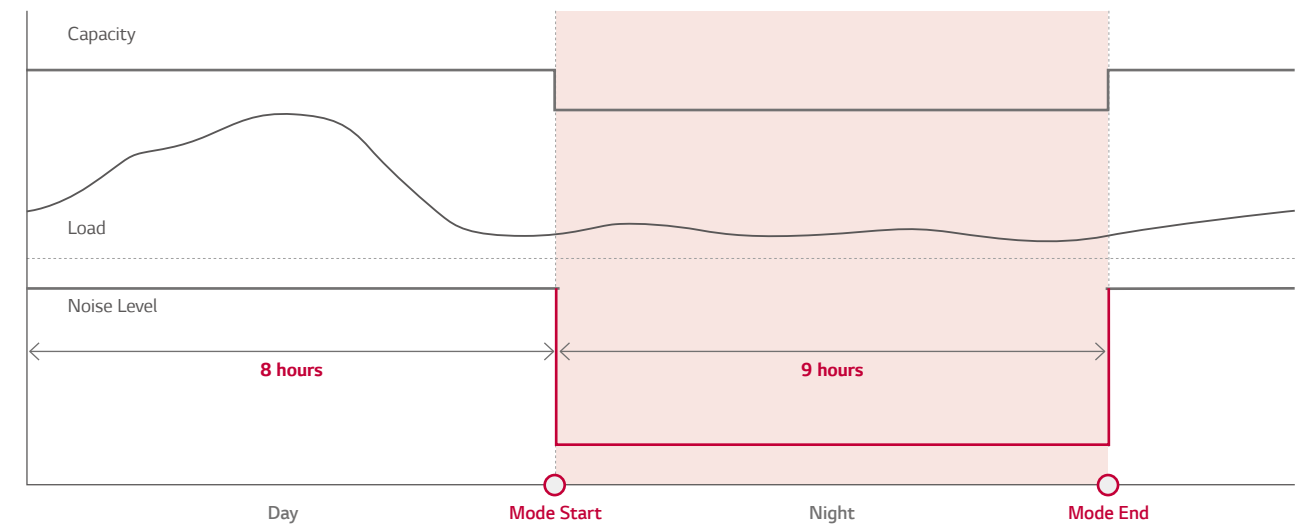

SMART

Outdoor Dry Contact

Air conditioners can be turned ON/OFF at the same time using the ON/OFF dry contact function that outdoor units have. (Models capacity over 10 kW).

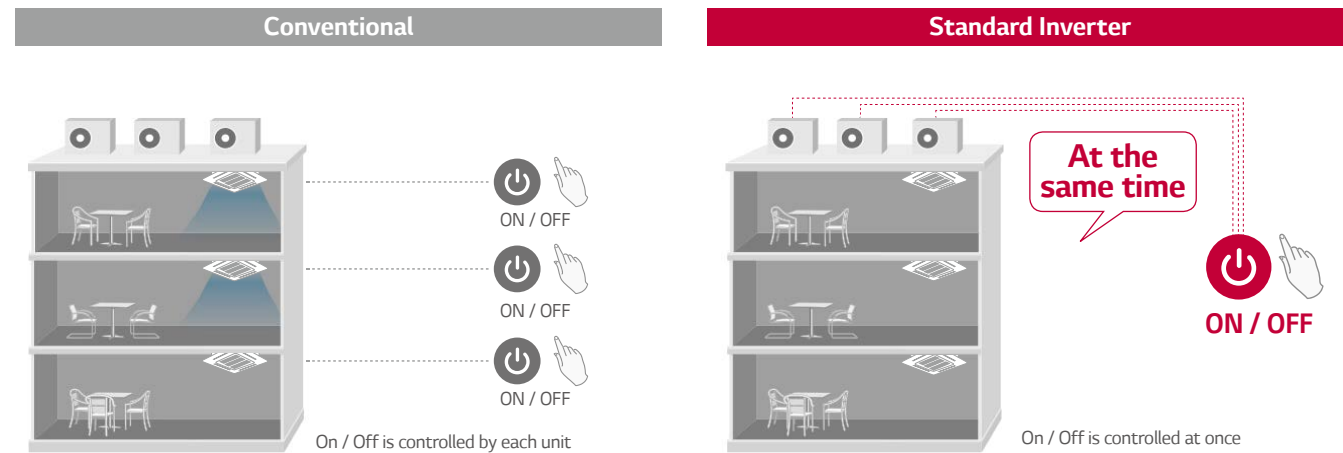

LG MV (Monitoring View)

LG MV helps engineers to inspect and monitor air conditioning units conveniently. Instructions are provided with the product type. (SINGLE Split & MULTI Split)

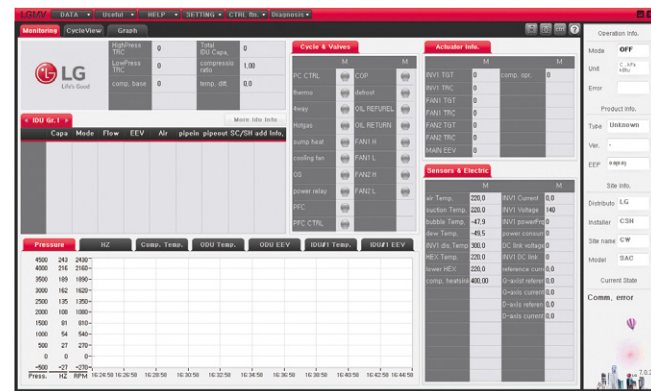

- IDU info.
- Cycle & Valves
- Actuator info.
- Sensors & Electricity
- ODU info.

LG MV displays cycle info represented by diagrams. It assists the user to check for data that is concentrated on a graph. A technician can easily obtain info about the error status by looking up the Error Indicator table. (Troubleshooting guide)

• Error Indicator

Error Code	Contents
01	Air temperature sensor of indoor unit
02	Inlet pipe temperature sensor of indoor unit
03	Communication error : Wired Remote Controller ↔ Indoor Unit

⋮

Weekly Program

You can allot 2 reservations for one day, and up to 14 reservations for a week.

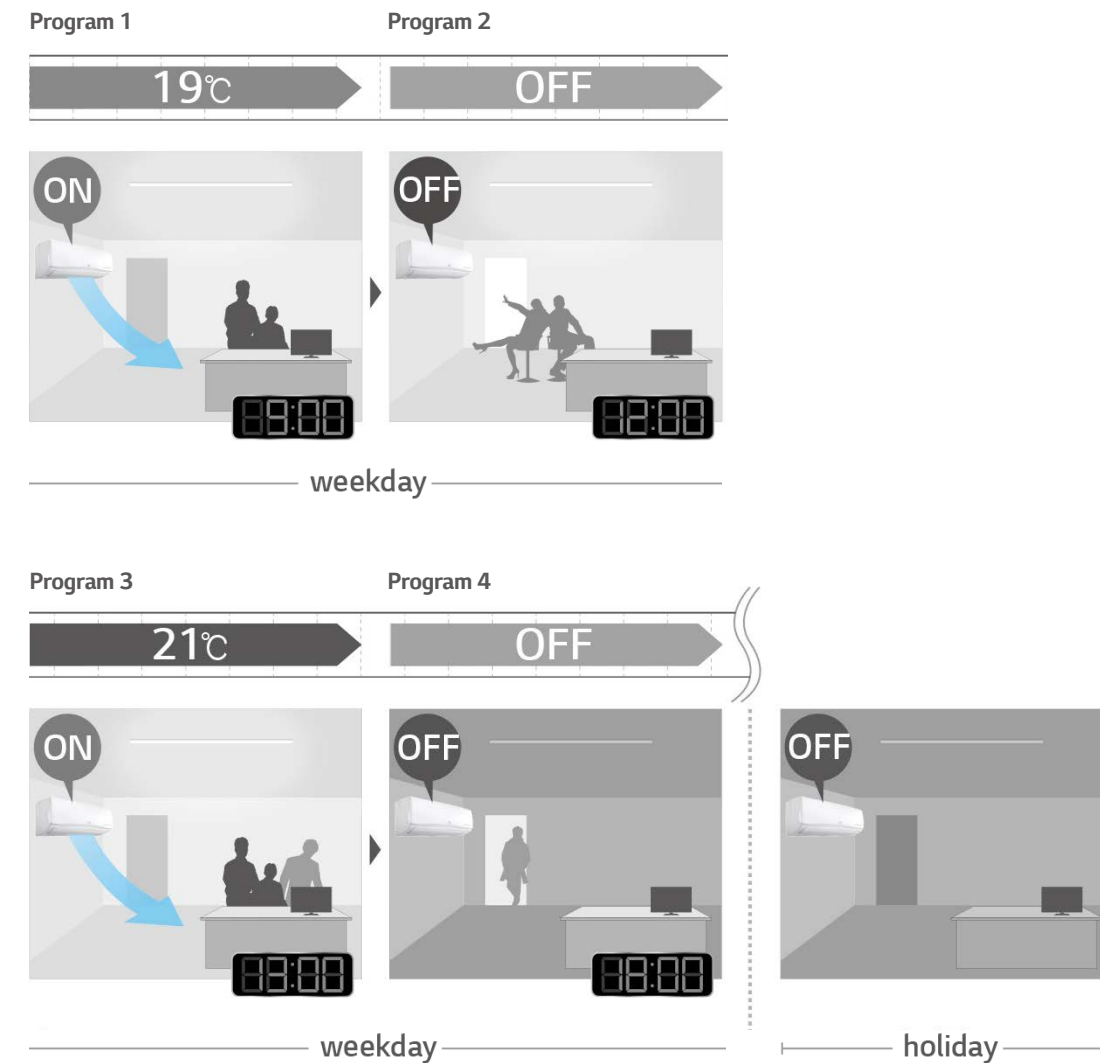

SMART

Wi-fi

Control your air conditioners via using the smart internet devices as Android or iOS based smartphones.
Wi-Fi modem (PWFMD200) is required by option.

• Access your air conditioner anytime and from anywhere

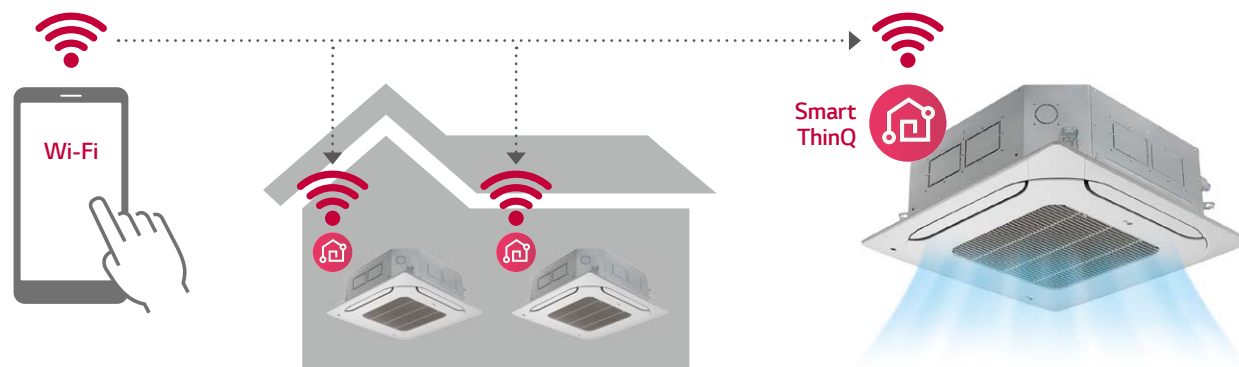

• Simple operation for various functions

- ON/OFF
- Mode Selection
- Current temperature
- Set temperature
- Vane Control
- Reservation
- Energy Monitoring
- Filter Management

※ Search "LG Smart ThinQ" on Google market or Appstore then download the app.



PERFORMANCE

Wide Operation Range

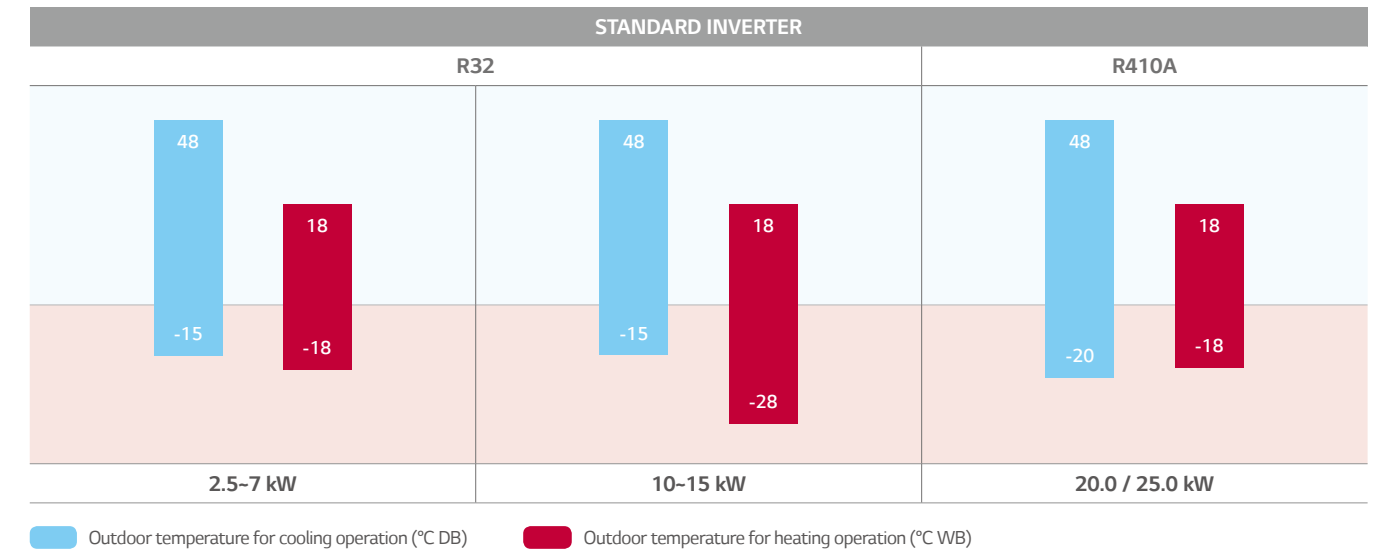

Stable Operation

High and stable cooling performance at low temperatures.

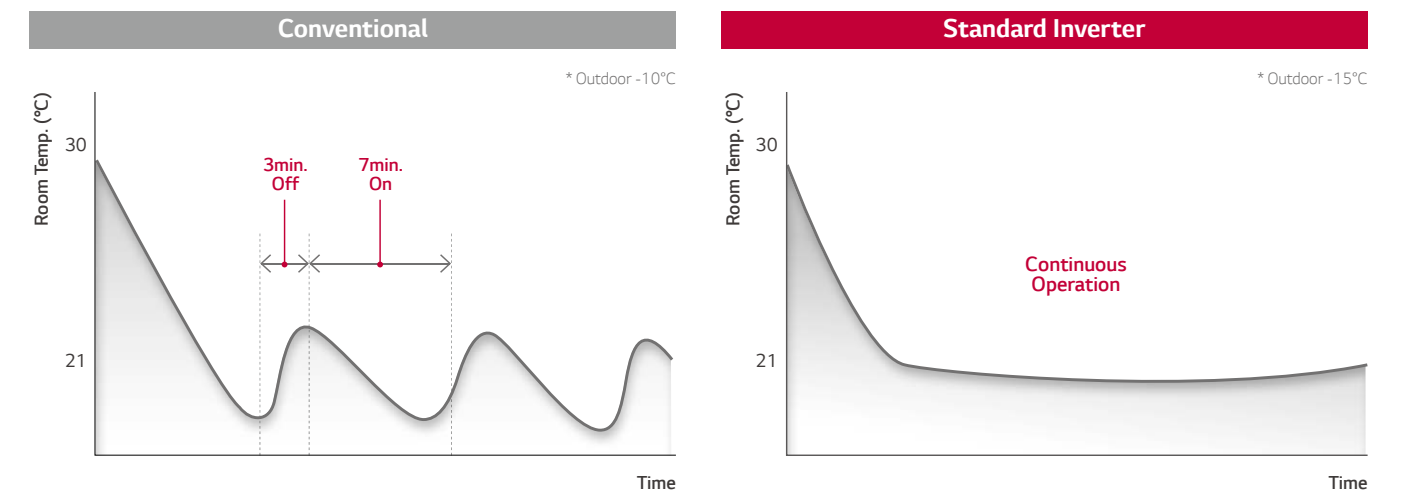

QUIET OPERATION

Advanced Grille & Fan

The improved grille shape design on the outdoor unit helps to distribute air more efficiently which improves heat exchange and reduces the noise level. The new axial Fan has a thick front edge and a smooth rear edge, thus providing not only high efficiency, low noise, wide fan, but also improving the air flow rate.

Grille

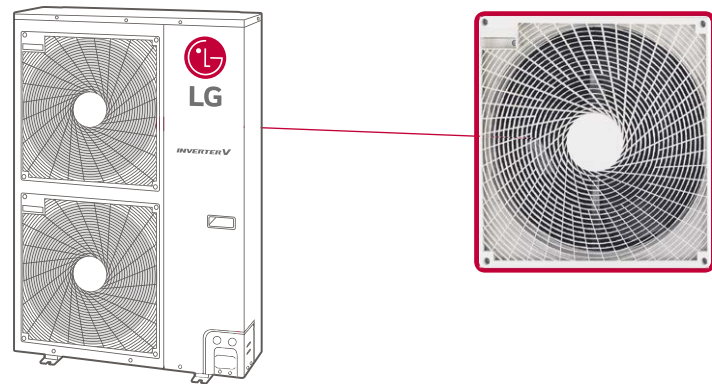

Fan Type 1

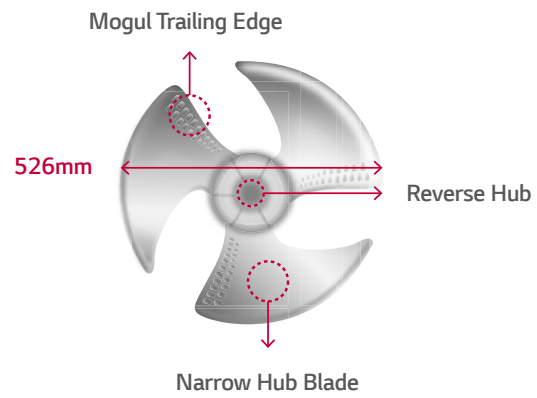

Fan Type 2

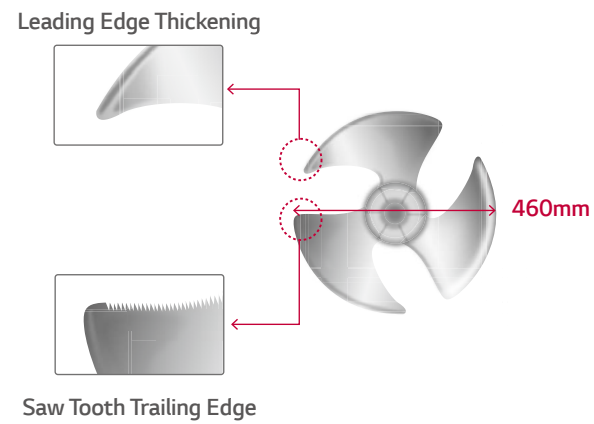

CEILING MOUNTED CASSETTE



CEILING MOUNTED CASSETTE

Compact Size

The indoor unit with slim and compact dimensions allows successful installation by easily accommodating it in various places of restricted area space.

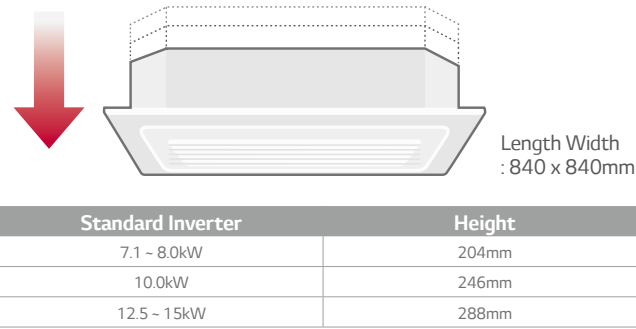

620 Panel – Compact and Stylish Design

- New 4 way cassette panel adapted unibody shape and matching with into the ceiling
- Panel size is fit into the ceiling tile

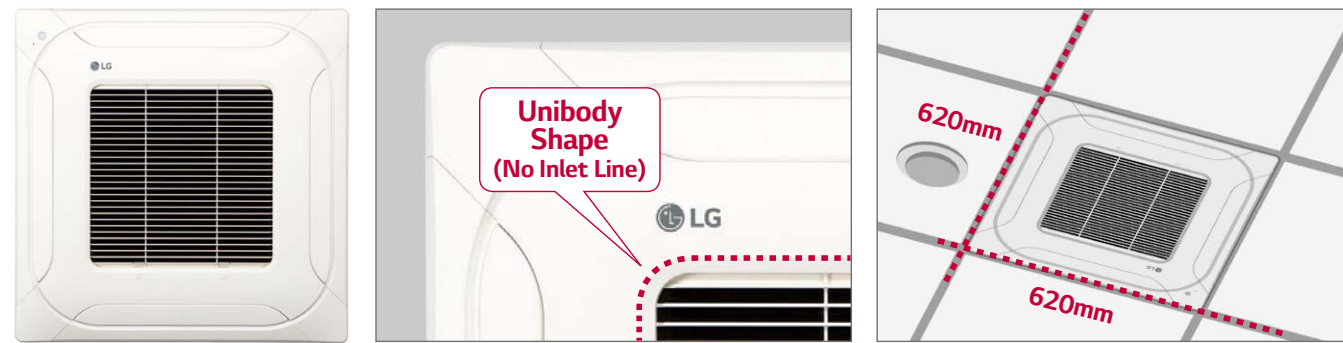

High Ceiling Mode

High ceiling mode provides powerful cooling and heating up to 4.2m in height, from ceiling to floor.

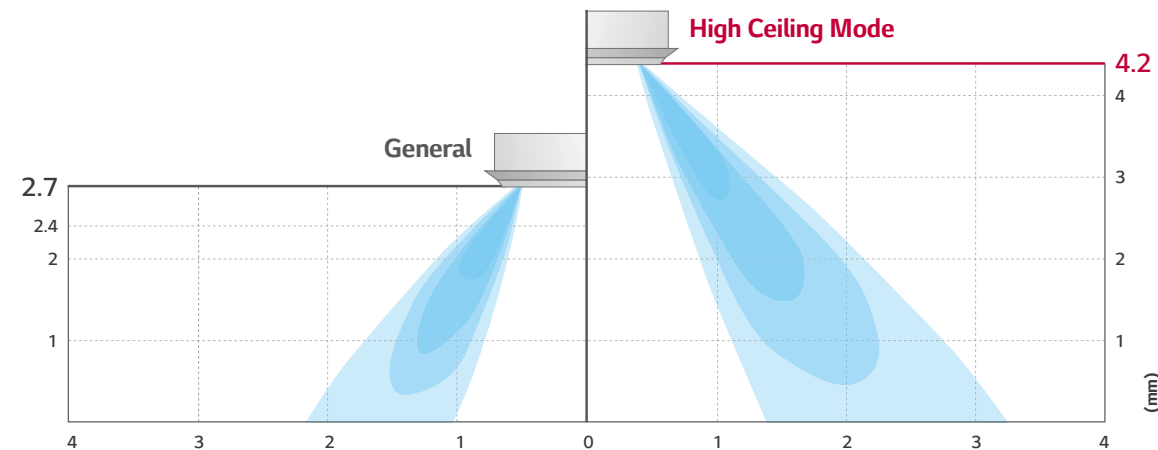

Human detect sensor & humidity sensor

Human detection sensor (PTVSMA0)

Apply human detection sensor

- Apply vision sensor
- Saving energy
- Supply comfortable flow
- Sensor is optional accessory only can be applied to PT-MCHWO

Comfortable and Power Saving Control based on Humidity

Apply humidity sensor

- Saving energy
- (To apply humidity sensor, new remote controller, PREMTB100 or PREMTBB10 is needed)

• Detection

Motion sensors detect the activity of people per 20seconds

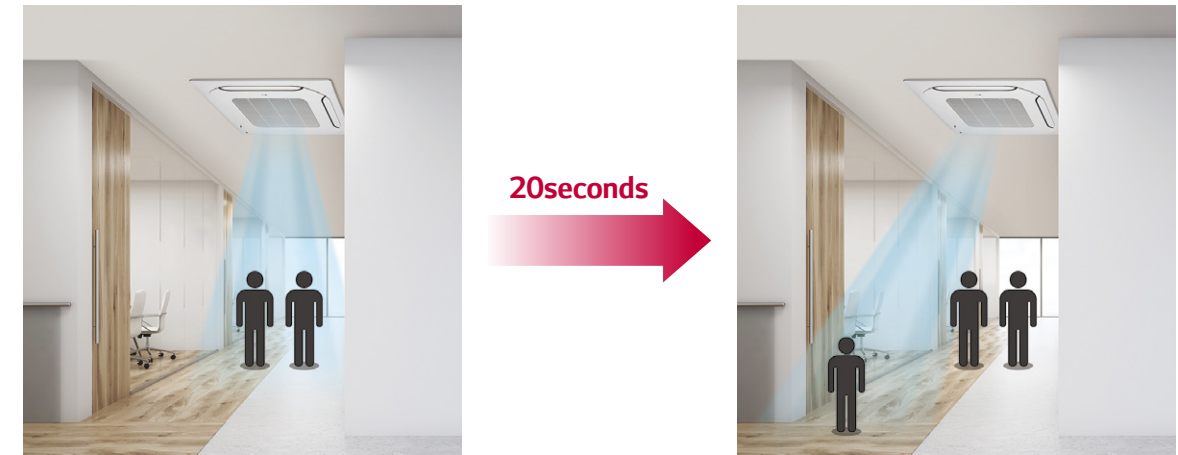

• Detection range

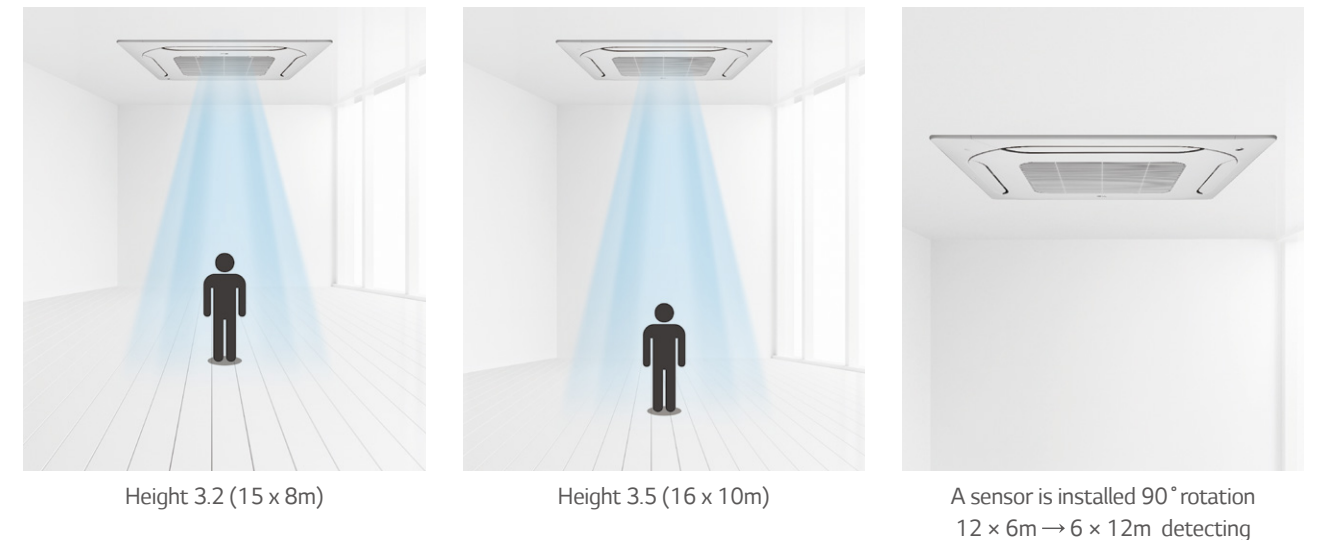

CEILING MOUNTED CASSETTE

950/700 Panel – Wide Jet Air Flow

Improved vanes reduce the curved area and provide even distribution.



Convenient Panel Installation

The detachable corner design makes it convenient to adjust the hanger during installation and to check for leakages in the drain connection pipe.

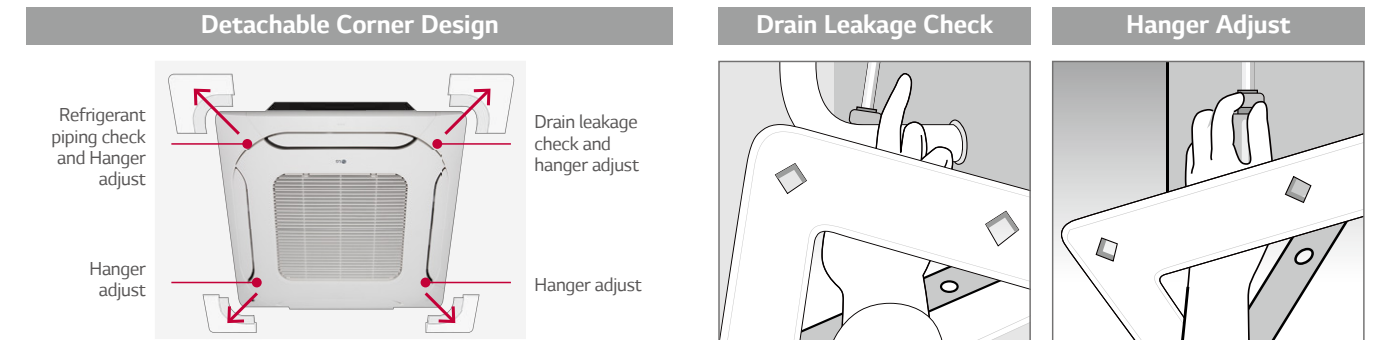

It is easy to attach the panel to the body, using the button type panel design

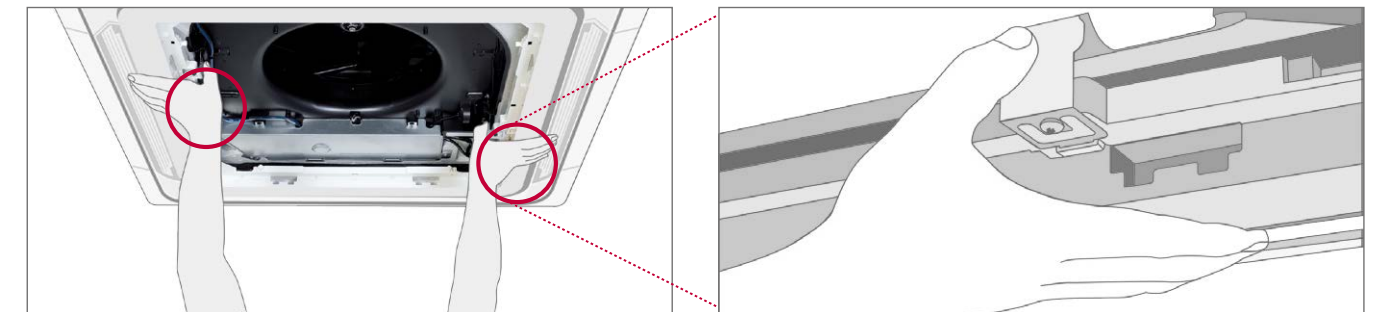

Independent Vane Operation

The independent vane operation feature uses separate motors, making it possible to control all four vanes independently.

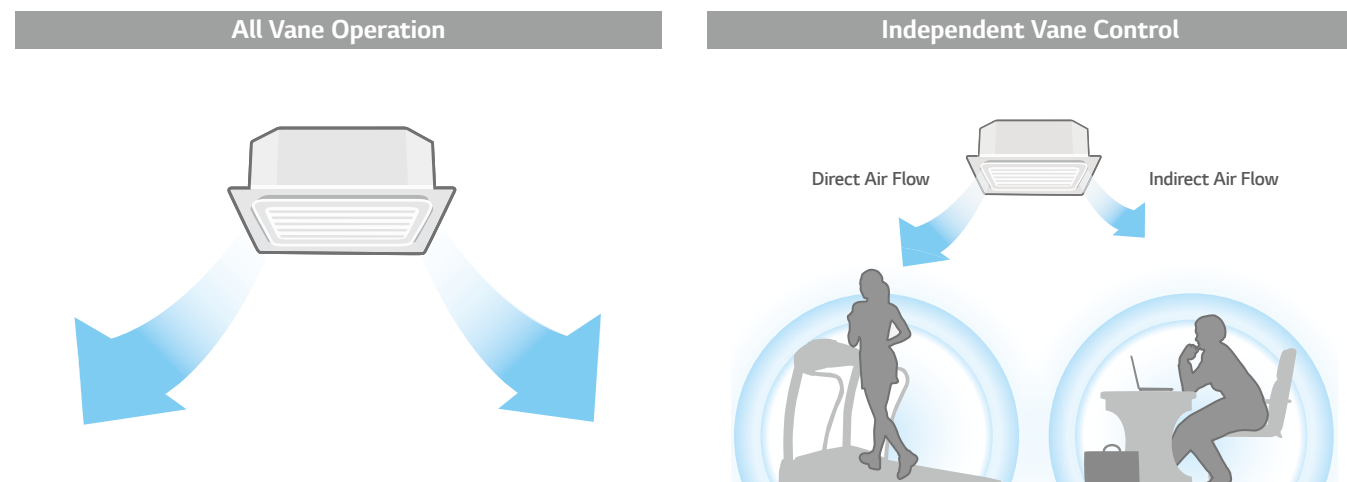

* Wired remote controller PQRCVSL0 (QW) applied

Auto Elevation Grille

Easy filter cleaning by using the elevation grill.

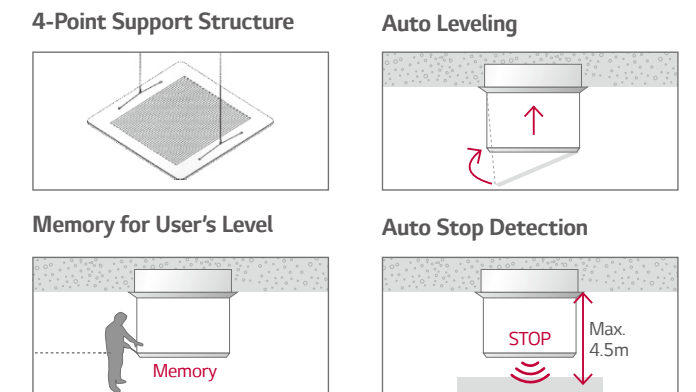

* Operating with wired remote controller PREMTB100, PREMTB001 and wireless remote controller included in PTEGMO.
* Except CT09 NR2 / CT12 NR2 / CT18 NQ2
* Applied to cassette panel PT-UMC1

CEILING MOUNTED CASSETTE

Quiet Operation with 3D Fan

New technology of 3D fan is applied to H-Inverter cassettes 10 ~ 14kW. It increases air flow but reduces noise.

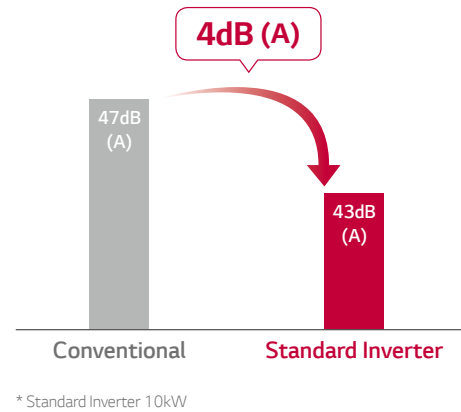
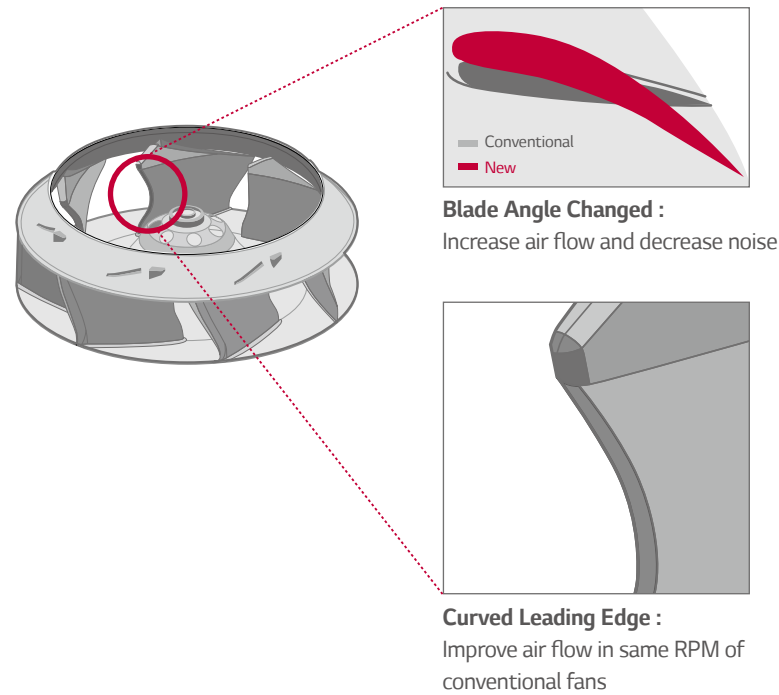

Prevent Ceiling Pollution

Coanda design of air outlet can prevent contamination of ceiling.

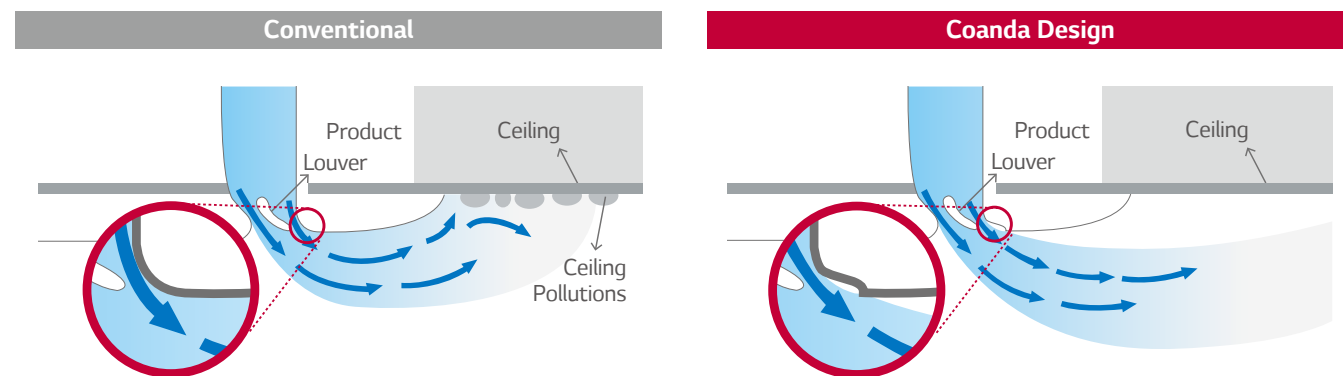

CEILING MOUNTED CASSETTE



STANDARD INVERTER (R32)

CT09R
CT12R
CT18R
CT24R



UU09WR
UU12WR

UU18WR

UU24WR



LG participates in the ECP programme for EUROVENT AC program. Check ongoing validity of certification : www.eurovent-certification.com

INDOOR				CT09R NRO	CT12R NRO	CT18R NQO	CT24R NPO
Capacity	Cooling	Min / Nom / Max	kW	1.0 / 2.5 / 2.8	1.4 / 3.4 / 3.9	2.0 / 5.0 / 5.7	2.84 / 6.8 / 7.8
	Heating	Min / Nom / Max	kW	1.2 / 3.2 / 3.4	1.6 / 4.0 / 4.6	2.2 / 5.8 / 6.8	3.2 / 8.0 / 8.8
Low Temperature Capacity	Heating -7°C	Max	kW	2.7	3.6	4.9	7.2
	Cooling	Nom	kW	0.63	0.97	1.56	1.94
Power Input (Set)	Heating	Nom	kW	0.75	1.12	1.66	2.00
	Power Input (Indoor)	Min / Nom / Max	W	10 / 20 / 20	10 / 20 / 20	10 / 30 / 40	20 / 50 / 60
Running Current	Cooling / Heating	Nom	A	2.7 / 3.5	4.3 / 5.0	7.1 / 7.5	8.6 / 8.8
Power Supply		Ø / V / Hz		1 / 220-240 / 50	1 / 220-240 / 50	1 / 220-240 / 50	1 / 220-240 / 50
EER				4.00	3.51	3.21	3.51
COP				4.00	3.58	3.49	4.00
SEER				6.77	6.58	6.25	7.70
SCOP				4.36	4.40	4.25	4.60
Pdesign (@-10°C)			kW	3.0	3.0	4.1	5.8
Seasonal Energy Label	Cooling / Heating (A++ to E Scale)			A++ / A+	A++ / A+	A++ / A+	A++ / A+
Annual Energy Consumption	Cooling / Heating		kWh	129 / 963	181 / 955	280 / 1,351	309 / 1,765
	Liquid		mm (inch)	Ø 6.35 (1/4)	Ø 6.35 (1/4)	Ø 6.35 (1/4)	Ø 9.52 (3/8)
Piping Connection	Gas		mm (inch)	Ø 9.52 (3/8)	Ø 9.52 (3/8)	Ø 12.7 (1/2)	Ø 15.88 (5/8)
	Drain	O.D. / I.D.	mm	32 / 25	32 / 25	32 / 25	32 / 25
Air Flow Rate	High / Medium / Low		m³/min	8.5 / 7.0 / 6.0	9.5 / 8.0 / 7.0	13.0 / 12.0 / 11.0	17.0 / 15.0 / 13.0
Sound Pressure	Cooling	High / Medium / Low	dBA	36 / 33 / 30	38 / 35 / 32	41 / 39 / 36	38 / 36 / 34
	Cooling	Max	dBA	52	52	57	57
Dehumidification Rate			l/h	0.9	1.4	2.0	2.7
Dimensions	Body	W x H x D	mm	570 x 214 x 570	570 x 214 x 570	570 x 256 x 570	840 x 204 x 840
	Body		kg	14.0	14.0	14.3	20.5
Net Weight	Model			PT-QCHW0	PT-QCHW0	PT-QCHW0	PT-MCHW0
	Color			Morning Fog	Morning Fog	Morning Fog	Morning Fog
Decoration Panel	Dimensions	W x H x D	mm	620 x 20 x 620	620 x 20 x 620	620 x 20 x 620	950 x 25 x 950
	Weight		kg	3.0	3.0	3.0	6.3

OUTDOOR				UU09WR ULO	UU12WR ULO	UU18WR U20	UU24WR U40
Compressor	Type			Twin Rotary	Twin Rotary	Twin Rotary	Twin Rotary
Airflow Rate	Nom		m³/min	32	32	50	58
	Cooling	Nom	dBA	47	49	47	48
Sound Pressure	Heating	Nom	dBA	50	52	52	52
	Cooling	Max	dBA	65	65	63	67
Dimensions	W x H x D		mm	770 x 545 x 288	770 x 545 x 288	870 x 650 x 330	950 x 834 x 330
Net Weight			kg	33.8	33.8	44.8	56.1
	Type			R32	R32	R32	R32
Refrigerant	Charge		g	900	900	1,100	1,600
	Additional Charge (after 7.5m)		g/m	20	20	20	35
GWP				675	675	675	675
	t-CO ₂ eq			0.61	0.61	0.74	1.08
Operation Range (Outdoor)	Cooling	Min - Max	°C DB	-15 - 48	-15 - 48	-15 - 48	-15 - 48
	Heating	Min - Max	°C WB	-18 - 18	-18 - 18	-18 - 18	-18 - 18
Power Supply			Ø / V / Hz	1 / 220-240 / 50	1 / 220-240 / 50	1 / 220-240 / 50	1 / 220-240 / 50
Power Supply Cable			No. x mm²	3C x 2.5	3C x 2.5	3C x 2.5	3C x 2.5
Transmission Cable			No. x mm²	4C x 0.75	4C x 0.75	4C x 0.75	4C x 0.75
Circuit Breaker			A	15	15	20	25
Piping Length Total	Min - Max		m	5-20	5-20	5-30	5-50
Piping Elevation Difference	IDU - ODU	Max	m	15	15	30	30
	Liquid		mm (inch)	Ø 6.35 (1/4)	Ø 6.35 (1/4)	Ø 6.35 (1/4)	Ø 9.52 (3/8)
Piping Connection	Gas		mm (inch)	Ø 9.52 (3/8)	Ø 9.52 (3/8)	Ø 12.7 (1/2)	Ø 15.88 (5/8)

Note: 1. Due to our policy of innovation some specifications may be changed without notification.
 2. Definition of Power Input Nominal conditions - Performance tested under EN14511
 3. Capacities are based on the following conditions:
 Cooling : - Indoor Temperature 27°C DB / 19°C WB - Outdoor Temperature 35°C DB / 24°C WB Heating : - Indoor Temperature 20°C DB / 15°C WB - Outdoor Temperature 7°C DB / 6°C WB
 4. Annual energy consumption : based on average use of 350 running hours in cooling and 1,400 hours in heating per year at seasonal condition
 5. This product contains fluorinated greenhouse gases (R32)

CEILING MOUNTED CASSETTE



STANDARD INVERTER (R32)

UT36R
UT42R
UT48R
UT60R



UU36WR UU42WR
UU48WR UU60WR



LG participates in the ECP programme for EUROVENT AC program.
Check ongoing validity of certification
:www.eurovent-certification.com

INDOOR				UT36R.NMO	UT42R.NMO	UT48R.NMO	UT60R.NMO
Capacity	Cooling	Min / Nom / Max	kW	4.5 / 9.5 / 13.0	5.0 / 12.0 / 14.5	5.5 / 13.4 / 16.0	5.9 / 14.6 / 16.3
	Heating	Min / Nom / Max	kW	5.0 / 10.8 / 13.7	5.5 / 13.5 / 16.5	6.1 / 15.5 / 18.0	6.8 / 16.9 / 18.7
Low Temperature Capacity	Heating -7°C	Max	kW	9.8	12.5	14.3	15.2
				Power Input (Set)	Cooling	Nom	kW
Power Input (Set)	Heating	Nom	kW	2.80	3.75	4.82	5.60
				Power Input (Indoor)	Min / Nom / Max	W	40 / 190 / 210
Running Current	Cooling / Heating	Nom	A	10.7 / 12.2	15.2 / 16.3	18.9 / 21.0	23.4 / 24.3
Power Supply			Ø / V / Hz	1 / 220-240 / 50	1 / 220-240 / 50	1 / 220-240 / 50	1 / 220-240 / 50
EER				3.85	3.43	3.08	2.71
COP				3.86	3.60	3.22	3.02
SEER				6.50	6.10	5.87	5.57
SCOP				4.30	4.10	4.04	3.92
Pdesign (@-10°C)			kW	8.05	8.05	9.30	9.30
Seasonal Energy Label	Cooling / Heating			A++ / A+ (A++ to E Scale)	A++ / A+	-	-
Annual Energy Consumption	Cooling / Heating		kWh	512 / 2,605	689 / 2,732	1,370 / 3,223	1,573 / 3,321
	Liquid		mm (inch)	Ø 9.52 (3/8)	Ø 9.52 (3/8)	Ø 9.52 (3/8)	Ø 9.52 (3/8)
Piping Connection	Gas		mm (inch)	Ø 15.88 (5/8)	Ø 15.88 (5/8)	Ø 15.88 (5/8)	Ø 15.88 (5/8)
	Drain	O.D. / I.D.	mm	32 / 25	32 / 25	32 / 25	32 / 25
				Air Flow Rate	High / Medium / Low	m ³ /min	30.0 / 25.0 / 20.0
Sound Pressure	Cooling	High / Medium / Low	dBA	46 / 43 / 40	47 / 44 / 41	47 / 44 / 41	47 / 44 / 41
Sound Power	Cooling	Max	dBA	62	64	64	66
Dehumidification Rate			l/h	2.7	4.2	5.2	6.2
Dimensions	Body	W x H x D	mm	840 x 288 x 840	840 x 288 x 840	840 x 288 x 840	840 x 288 x 840
	Net Weight		kg	24.6	24.6	24.6	24.6
Decoration Panel	Model			PT-MCHW0	PT-MCHW0	PT-MCHW0	PT-MCHW0
	Color			Morning Fog	Morning Fog	Morning Fog	Morning Fog
	Dimensions	W x H x D	mm	950 x 25 x 950	950 x 25 x 950	950 x 25 x 950	950 x 25 x 950
	Weight		kg	6.3	6.3	6.3	6.3

OUTDOOR				UU36WR.U30	UU42WR.U30	UU48WR.U30	UU60WR.U30
Compressor	Type			R-Scroll	R-Scroll	R-Scroll	R-Scroll
Airflow Rate	Nom		m ³ /min	110	110	110	110
Sound Pressure	Cooling	Nom	dBA	52	52	52	52
	Heating	Nom	dBA	54	54	54	54
Sound Power	Cooling	Max	dBA	66	67	68	68
Dimensions	W x H x D		mm	950 x 1,380 x 330	950 x 1,380 x 330	950 x 1,380 x 330	950 x 1,380 x 330
Net Weight			kg	87.5	87.5	87.5	87.5
Refrigerant	Type			R32	R32	R32	R32
	Charge		g	3,000	3,000	3,000	3,000
	Additional Charge (after 7.5m)		g/m	40	40	40	40
	GWP			675	675	675	675
t-CO ₂ eq			2.03	2.03	2.03	2.03	
Operation Range (Outdoor)	Cooling	Min - Max	°C DB	-15 - 48	-15 - 48	-15 - 48	-15 - 48
	Heating	Min - Max	°C WB	-25 - 18	-25 - 18	-25 - 18	-25 - 18
Power Supply			Ø / V / Hz	1 / 220-240 / 50	1 / 220-240 / 50	1 / 220-240 / 50	1 / 220-240 / 50
Power Supply Cable			No. x mm ²	3C x 6.0	3C x 6.0	3C x 6.0	3C x 6.0
Transmission Cable			No. x mm ²	4C x 0.75	4C x 0.75	4C x 0.75	4C x 0.75
Circuit Breaker			A	40	40	40	40
Piping Length Total		Min - Max	m	5-85	5-85	5-85	5-85
Piping Elevation Difference	IDU - ODU	Max	m	30	30	30	30
	Liquid		mm (inch)	Ø 9.52 (3/8)	Ø 9.52 (3/8)	Ø 9.52 (3/8)	Ø 9.52 (3/8)
Piping Connection	Gas		mm (inch)	Ø 15.88 (5/8)	Ø 15.88 (5/8)	Ø 15.88 (5/8)	Ø 15.88 (5/8)

Note : 1. Due to our policy of innovation some specifications may be changed without notification.
2. Definition of Power Input Nominal conditions - Performance tested under EN14511
3. Capacities are based on the following conditions:
Cooling : - Indoor Temperature 27°C DB / 19°C WB - Outdoor Temperature 35°C DB / 24°C WB Heating : - Indoor Temperature 20°C DB / 15°C WB - Outdoor Temperature 7°C DB / 6°C WB
4. Annual energy consumption : based on average use of 350 running hours in cooling and 1,400 hours in heating per year at seasonal condition
5. This product contains fluorinated greenhouse gases (R32)

STANDARD INVERTER (R32)

UT36R
UT42R
UT48R
UT60R



UU37WR UU42WR
UU49WR UU61WR



LG participates in the ECP programme for EUROVENT AC program.
Check ongoing validity of certification
:www.eurovent-certification.com



INDOOR				UT36R.NMO	UT42R.NMO	UT48R.NMO	UT60R.NMO
Capacity	Cooling	Min / Nom / Max	kW	4.5 / 9.5 / 13.0	5.0 / 12.0 / 14.5	5.5 / 13.4 / 16.0	5.9 / 14.6 / 16.3
	Heating	Min / Nom / Max	kW	5.0 / 10.8 / 13.7	5.5 / 13.5 / 16.5	6.1 / 15.5 / 18.0	6.8 / 16.9 / 18.7
Low Temperature Capacity	Heating -7°C	Max	kW	9.8	12.5	14.3	15.2
				Power Input (Set)	Cooling	Nom	kW
Power Input (Set)	Heating	Nom	kW	2.80	3.75	4.82	5.60
				Power Input (Indoor)	Min / Nom / Max	W	40 / 190 / 210
Running Current	Cooling / Heating	Nom	A	3.6 / 4.0	5.1 / 5.4	5.8 / 6.4	7.8 / 8.1
Power Supply			Ø / V / Hz	1 / 220-240 / 50	1 / 220-240 / 50	1 / 220-240 / 50	1 / 220-240 / 50
EER				3.85	3.43	3.08	2.71
COP				3.86	3.60	3.22	3.02
SEER				6.50	6.18	5.87	5.57
SCOP				4.30	4.17	4.04	3.92
Pdesign (@-10°C)			kW	8.05	8.05	9.30	9.30
Seasonal Energy Label	Cooling / Heating			A++ / A+ (A++ to E Scale)	A++ / A+	-	-
Annual Energy Consumption	Cooling / Heating		kWh	512 / 2,605	689 / 2,732	1,370 / 3,223	1,573 / 3,321
	Liquid		mm (inch)	Ø 9.52 (3/8)	Ø 9.52 (3/8)	Ø 9.52 (3/8)	Ø 9.52 (3/8)
Piping Connection	Gas		mm (inch)	Ø 15.88 (5/8)	Ø 15.88 (5/8)	Ø 15.88 (5/8)	Ø 15.88 (5/8)
	Drain	O.D. / I.D.	mm	32 / 25	32 / 25	32 / 25	32 / 25
				Air Flow Rate	High / Medium / Low	m ³ /min	30.0 / 25.0 / 20.0
Sound Pressure	Cooling	High / Medium / Low	dBA	46 / 43 / 40	47 / 44 / 41	47 / 44 / 41	47 / 44 / 41
Sound Power	Cooling	Max	dBA	62	64	64	66
Dehumidification Rate			l/h	2.7	4.2	5.2	6.2
Dimensions	Body	W x H x D	mm	840 x 288 x 840	840 x 288 x 840	840 x 288 x 840	840 x 288 x 840
	Net Weight		kg	24.6	24.6	24.6	24.6
Decoration Panel	Model			PT-MCHW0	PT-MCHW0	PT-MCHW0	PT-MCHW0
	Color			Morning Fog	Morning Fog	Morning Fog	Morning Fog
	Dimensions	W x H x D	mm	950 x 25 x 950	950 x 25 x 950	950 x 25 x 950	950 x 25 x 950
	Weight		kg	6.3	6.3	6.3	6.3

OUTDOOR				UU37WR.U30	UU43WR.U30	UU49WR.U30	UU61WR.U30
Compressor	Type			R-Scroll	R-Scroll	R-Scroll	R-Scroll
Airflow Rate	Nom		m ³ /min	110	110	110	110
Sound Pressure	Cooling	Nom	dBA	52	52	52	52
	Heating	Nom	dBA	54	54	54	54
Sound Power	Cooling	Max	dBA	66	67	68	68
Dimensions	W x H x D		mm	950 x 1,380 x 330	950 x 1,380 x 330	950 x 1,380 x 330	950 x 1,380 x 330
Net Weight			kg	87.5	87.5	87.5	87.5
Refrigerant	Type			R32	R32	R32	R32
	Charge		g	3,000	3,000	3,000	3,000
	Additional Charge (after 7.5m)		g/m	40	40	40	40
	GWP			675	675	675	675
t-CO ₂ eq			2.03	2.03	2.03	2.03	
Operation Range (Outdoor)	Cooling	Min - Max	°C DB	-15 - 48	-15 - 48	-15 - 48	-15 - 48
	Heating	Min - Max	°C WB	-25 - 18	-25 - 18	-25 - 18	-25 - 18
Power Supply			Ø / V / Hz	3 / 380-415 / 50	3 / 380-415 / 50	3 / 380-415 / 50	3 / 380-415 / 50
Power Supply Cable			No. x mm ²	5C x 2.5	3C x 6.0	5C x 2.5	5C x 2.5
Transmission Cable			No. x mm ²	4C x 0.75	4C x 0.75	4C x 0.75	4C x 0.75
Circuit Breaker			A	20	20	20	20
Piping Length Total		Min - Max	m	5-85	5-85	5-85	5-85
Piping Elevation Difference	IDU - ODU	Max	m	30	30	30	30
	Liquid		mm (inch)	Ø 9.52 (3/8)	Ø 9.52 (3/8)	Ø 9.52 (3/8)	Ø 9.52 (3/8)
Piping Connection	Gas		mm (inch)	Ø 15.88 (5/8)	Ø 15.88 (5/8)	Ø 15.88 (5/8)	Ø 15.88 (5/8)

Note : 1. Due to our policy of innovation some specifications may be changed without notification.
2. Definition of Power Input Nominal conditions - Performance tested under EN14511
3. Capacities are based on the following conditions:
Cooling : - Indoor Temperature 27°C DB / 19°C WB - Outdoor Temperature 35°C DB / 24°C WB Heating : - Indoor Temperature 20°C DB / 15°C WB - Outdoor Temperature 7°C DB / 6°C WB
4. Annual energy consumption : based on average use of 350 running hours in cooling and 1,400 hours in heating per year at seasonal condition
5. This product contains fluorinated greenhouse gases (R32)

CEILING MOUNTED CASSETTE

STANDARD INVERTER (R410A)

CT09
CT12
CT18



UU09W
UU12W



UU18W



LG participates in the ECP programme for EUROVENT AC program.
Check ongoing validity of certification
:www.eurovent-certification.com

INDOOR				CT09 NR2	CT12 NR2	CT18 NQ4	
Capacity	Cooling	Min / Nom / Max	kW	1.0 / 2.5 / 2.8	1.4 / 3.4 / 3.7	2.0 / 5.0 / 5.5	
	Heating	Min / Nom / Max	kW	1.2 / 3.0 / 3.3	1.6 / 4.0 / 4.4	2.2 / 5.8 / 6.8	
Low Temperature Capacity	Heating -7°C	Max	kW	2.7	3.6	4.9	
				Power Input (Set)	Cooling	Nom	kW
Power Input (Set)	Heating	Nom	kW	0.81	1.10	1.66	
				Power Input (Indoor)	Nom	W	20
Running Current	Cooling / Heating	Nom	A	3.3 / 3.5	4.61 / 4.78	7.1 / 7.5	
Power Supply	Ø / V / Hz			1 / 220-240 / 50	1 / 220-240 / 50	1 / 220-240 / 50	
EER				3.33	3.21	3.22	
COP				3.70	3.64	3.62	
SEER				5.11	5.61	6.10	
SCOP				3.81	3.91	4.25	
Pdesign (@ -10°C)	kW			2.8	3.0	4.1	
Seasonal Energy Label	Cooling / Heating (A++ to E Scale)			A / A	A+ / A	A++ / A+	
Annual Energy Consumption	Cooling / Heating		kWh	172 / 1,032	213 / 1,077	287 / 1,351	
	Liquid			mm (inch)	Ø 6.35 (1/4)	Ø 6.35 (1/4)	Ø 6.35 (1/4)
Piping Connection	Gas			mm (inch)	Ø 9.52 (3/8)	Ø 9.52 (3/8)	Ø 12.7 (1/2)
	Drain			mm	32 / 25	32 / 25	32 / 25
		O.D. / I.D.					
Air Flow Rate	High / Medium / Low		m³/min	8.5 / 7.0 / 6.0	9.5 / 8.0 / 7.0	13.0 / 12.0 / 11.0	
Sound Pressure	Cooling	High / Medium / Low	dBA	36 / 33 / 30	38 / 35 / 32	41 / 39 / 36	
Sound Power	Cooling	Max	dBA	48	51	57	
Dehumidification Rate				1.4	1.7	2.1	
Dimensions	Body	W x H x D	mm	570 x 214 x 570	570 x 214 x 570	570 x 256 x 570	
	Net Weight			kg	14.0	14.0	15.3
Decoration Panel	Model			PT-UQC, PT-QCHW0			
	Color			Morning Fog (RAL 120-4)			
	Dimensions	W x H x D	mm	700 x 22 x 700, 620 x 20 x 620			
	Weight			kg	3.0		

OUTDOOR				UU09W ULD	UU12W ULD	UU18W UE4	
Compressor	Type			Rotary	Rotary	Twin Rotary	
Airflow Rate	Nom	m³/min		32	32	50	
Sound Pressure	Cooling	Nom		dBA	47	47	
	Heating	Nom		dBA	48	52	
Sound Power	Cooling	Max		dBA	56	63	
Dimensions	W x H x D			mm	770 x 540 x 245	770 x 540 x 245	870 x 655 x 320
Net Weight				kg	32.0	32.0	44.6
Refrigerant	Type			R410A			
	Charge			g	1,000	1,000	1,300
	Additional Charge			g/m	20	20	20
	GWP			-	2,087.5	2,087.5	2,087.5
	TCO2eq			-	2.1	2.1	2.7
Operation Range (Outdoor)	Cooling	Min - Max	°C DB	-10 - 43	-10 - 43	-15 - 48	
	Heating	Min - Max	°C WB	-18 - 18	-18 - 18	-18 - 18	
Power Supply	Ø / V / Hz			1 / 220-240 / 50	1 / 220-240 / 50	1 / 220-240 / 50	
Power Supply Cable	No. x mm²			3C x 2.5	3C x 2.5	3C x 2.5	
Transmission Cable	No. x mm²			4C x 0.75	4C x 0.75	4C x 0.75	
Circuit Breaker	A			15	15	20	
Piping Length Total	Min - Max			m	5-15	5-15	5-30
Piping Elevation Difference	IDU - ODU	Max		m	10	10	30
Piping Connection	Liquid			mm (inch)	Ø 6.35 (1/4)	Ø 6.35 (1/4)	Ø 6.35 (1/4)
	Gas			mm (inch)	Ø 9.52 (3/8)	Ø 9.52 (3/8)	Ø 12.7 (1/2)

Note : 1. Due to our policy of innovation some specifications may be changed without notification.
2. Definition of Power Input Nominal conditions - Performance tested under EN14511
3. Capacities are based on the following conditions:
Cooling : - Indoor Temperature 27°C DB / 19°C WB - Outdoor Temperature 35°C DB / 24°C WB Heating : - Indoor Temperature 20°C DB / 15°C WB - Outdoor Temperature 7°C DB / 6°C WB
4. Annual energy consumption : based on average use of 350 running hours in cooling and 1,400 hours in heating per year at seasonal condition
5. This product contains fluorinated greenhouse gases (R410A)

STANDARD INVERTER (R410A)

CT24
UT30



LG participates in the ECP programme for EUROVENT AC program.
Check ongoing validity of certification
:www.eurovent-certification.com

UU24W
UU30W



INDOOR				CT24 NP4	UT30 NP4	
Capacity	Cooling	Min / Nom / Max	kW	2.8 / 6.8 / 7.8	3.2 / 8.0 / 8.8	
	Heating	Min / Nom / Max	kW	3.2 / 8.0 / 8.8	3.6 / 9.0 / 9.9	
Low Temperature Capacity	Heating -7°C	Max	kW	7.2	8.1	
				Power Input (Set)	Cooling	Nom
Power Input (Set)	Heating	Nom	kW	2.22	2.72	
				Power Input (Indoor)	Nom	W
Running Current	Cooling / Heating	Nom	A	8.9 / 9.7	10.8 / 11.8	
Power Supply	Ø / V / Hz			1 / 220-240 / 50	1 / 220-240 / 50	
EER				3.70	3.21	
COP				3.62	3.31	
SEER				6.80	6.30	
SCOP				4.20	4.00	
Pdesign (@ -10°C)	kW			6.3	6.8	
Seasonal Energy Label	Cooling / Heating (A++ to E Scale)			A++ / A+	A++ / A+	
Annual Energy Consumption	Cooling / Heating		kWh	350 / 2,110	444 / 2,380	
	Liquid			mm (inch)	Ø 9.52 (3/8)	Ø 9.52 (3/8)
Piping Connection	Gas			mm (inch)	Ø 15.88 (5/8)	Ø 15.88 (5/8)
	Drain			mm	32 / 25	32 / 25
		O.D. / I.D.				
Air Flow Rate	High / Medium / Low		m³/min	17.0 / 15.0 / 13.0	19.0 / 17.0 / 15.0	
Sound Pressure	Cooling	High / Medium / Low	dBA	38 / 36 / 34	40 / 37 / 35	
Sound Power	Cooling	Max	dBA	57	58	
Dehumidification Rate				2.4	2.5	
Dimensions	Body	W x H x D	mm	840 x 204 x 840	840 x 204 x 840	
	Net Weight			kg	20.5	20.5
Decoration Panel	Model			PT-UMC1		
	Color			Morning Fog (RAL 120-4)		
	Dimensions	W x H x D	mm	950 x 25 x 950	950 x 25 x 950	
	Weight			kg	5.0	5.0

OUTDOOR				UU24W U44	UU30W U44	
Compressor	Type			Twin Rotary	Twin Rotary	
Airflow Rate	Nom	m³/min		58	58	
Sound Pressure	Cooling	Nom		dBA	48	48
	Heating	Nom		dBA	52	52
Sound Power	Cooling	Max		dBA	67	68
Dimensions	W x H x D			mm	950 x 834 x 330	950 x 834 x 330
Net Weight				kg	56.1	58.0
Refrigerant	Type			R410A		
	Charge			g	2,000	2,000
	Additional Charge			g/m	40	40
	GWP			-	2,087.5	2,087.5
	TCO2eq			-	4.2	4.2
Operation Range (Outdoor)	Cooling	Min - Max	°C DB	-15 - 48	-15 - 48	
	Heating	Min - Max	°C WB	-18 - 18	-18 - 18	
Power Supply	Ø / V / Hz			1 / 220-240 / 50	1 / 220-240 / 50	
Power Supply Cable	No. x mm²			3C x 2.5	3C x 2.5	
Transmission Cable	No. x mm²			4C x 0.75	4C x 0.75	
Circuit Breaker	A			25	25	
Piping Length Total	Min - Max			m	5 - 50	5 - 50
Piping Elevation Difference	IDU - ODU	Max		m	30	30
Piping Connection	Liquid			mm (inch)	Ø 9.52 (3/8)	Ø 9.52 (3/8)
	Gas			mm (inch)	Ø 15.88 (5/8)	Ø 15.88 (5/8)

Note : 1. Due to our policy of innovation some specifications may be changed without notification.
2. Definition of Power Input Nominal conditions - Performance tested under EN14511
3. Capacities are based on the following conditions:
Cooling : - Indoor Temperature 27°C DB / 19°C WB - Outdoor Temperature 35°C DB / 24°C WB Heating : - Indoor Temperature 20°C DB / 15°C WB - Outdoor Temperature 7°C DB / 6°C WB
4. Annual energy consumption : based on average use of 350 running hours in cooling and 1,400 hours in heating per year at seasonal condition
5. This product contains fluorinated greenhouse gases (R410A)

CEILING MOUNTED CASSETTE

STANDARD INVERTER (R410A)

UT36
UT42
UT48
UT60



UU36W UU42W
UU48W UU60W



LG participates in the ECP programme for EUROVENT AC program.
Check ongoing validity of certification
:www.eurovent-certification.com

INDOOR				UT36 NN2	UT42 NM2	UT48 NM2	UT60 NM2
Capacity	Cooling	Min / Nom / Max	kW	4.0 / 10.0 / 11.0	5.0 / 12.5 / 13.8	5.5 / 13.9 / 15.7	5.9 / 14.6 / 16.3
	Heating	Min / Nom / Max	kW	4.4 / 11.0 / 12.1	5.0 / 14.0 / 15.4	6.4 / 15.4 / 17.6	6.8 / 16.9 / 18.7
Low Temperature Capacity	Heating -7°C	Max	kW	9.8	12.5	14.3	15.2
		Nom	kW	2.82	3.89	4.62	5.40
Power Input (Set)	Cooling	Nom	kW	3.09	3.88	4.51	5.50
	Heating	Nom	W	140	210	210	210
Power Input (Indoor)		Nom	W	140	210	210	210
Running Current	Cooling / Heating	Nom	A	12.3 / 13.4	16.9 / 16.9	20.1 / 19.6	23.5 / 23.9
Power Supply			Ø / V / Hz	1 / 220-240 / 50	1 / 220-240 / 50	1 / 220-240 / 50	1 / 220-240 / 50
EER				3.55	3.21	3.01	2.70
COP				3.56	3.61	3.41	3.07
SEER				5.41	5.40	5.40	5.30
SCOP				3.81	3.55	3.55	3.55
Pdesign (@ -10°C)			kW	7.6	12.8	12.8	12.8
Seasonal Energy Label	Cooling / Heating			A / A (A++ to E Scale)	-	-	-
Annual Energy Consumption	Cooling / Heating		kWh	648 / 2,800	-	-	-
Piping Connection	Liquid		mm (inch)	Ø 9.52 (3/8)	Ø 9.52 (3/8)	Ø 9.52 (3/8)	Ø 9.52 (3/8)
	Gas		mm (inch)	Ø 15.88 (5/8)	Ø 15.88 (5/8)	Ø 15.88 (5/8)	Ø 15.88 (5/8)
	Drain	O.D. / I.D.	mm	32 / 25	32 / 25	32 / 25	32 / 25
Air Flow Rate		High / Medium / Low	m³/min	24.0 / 22.0 / 19.0	30.0 / 28.0 / 26.0	34.0 / 32.0 / 30.0	34.0 / 32.0 / 30.0
Sound Pressure	Cooling	High / Medium / Low	dBA	43 / 40 / 37	46 / 44 / 43	49 / 47 / 45	49 / 47 / 45
Sound Power	Cooling	Max	dBA	62	65	66	66
Dehumidification Rate			l/h	2.7	3.6	4.4	5.5
Dimensions	Body	W x H x D	mm	840 x 246 x 840	840 x 288 x 840	840 x 288 x 840	840 x 288 x 840
Net Weight	Body		kg	22.3	24.6	24.6	24.6
Decoration Panel	Model			PT-UMC1	PT-UMC1	PT-UMC1	PT-UMC1
	Color			Morning Fog (RAL 120-4)	Morning Fog (RAL 120-4)	Morning Fog (RAL 120-4)	Morning Fog (RAL 120-4)
	Dimensions	W x H x D	mm	950 x 25 x 950	950 x 25 x 950	950 x 25 x 950	950 x 25 x 950
	Weight		kg	5.0	5.0	5.0	5.0

OUTDOOR				UU36W UO2	UU42W U32	UU48W U32	UU60W U32
Compressor	Type			Twin Rotary	Twin Rotary	Twin Rotary	Twin Rotary
Airflow Rate	Nom		m³/min	90	110	110	110
Sound Pressure	Cooling	Nom	dBA	53	52	52	52
	Heating	Nom	dBA	54	54	54	54
Sound Power	Cooling	Max	dBA	66	67	68	71
Dimensions	W x H x D		mm	950 x 1,170 x 330	950 x 1,380 x 330	950 x 1,380 x 330	950 x 1,380 x 330
Net Weight			kg	81.0	92.0	92.0	92.0
Refrigerant	Type			R410A	R410A	R410A	R410A
	Charge		g	2,800	3,400	3,400	3,400
	Additional Charge		g/m	40	40	40	40
	GWP			2087.5	2087.5	2087.5	2087.5
	TCO2eq			5.8	7.1	7.1	7.1
Operation Range (Outdoor)	Cooling	Min - Max	°C DB	-15 - 48	-15 - 48	-15 - 48	-15 - 48
	Heating	Min - Max	°C WB	-18 - 18	-18 - 18	-18 - 18	-18 - 18
Power Supply			Ø / V / Hz	1 / 220-240 / 50	1 / 220-240 / 50	1 / 220-240 / 50	1 / 220-240 / 50
Power Supply Cable			No. x mm²	3C x 5.0	3C x 5.0	3C x 5.0	3C x 5.0
Transmission Cable			No. x mm²	4C x 0.75	4C x 0.75	4C x 0.75	4C x 0.75
Circuit Breaker			A	40	40	40	40
Piping Length Total		Min - Max	m	5 - 50	5 - 75	5 - 75	5 - 75
Piping Elevation Difference	IDU - ODU	Max	m	30	30	30	30
Piping Connection	Liquid		mm (inch)	Ø 9.52 (3/8)	Ø 9.52 (3/8)	Ø 9.52 (3/8)	Ø 9.52 (3/8)
	Gas		mm (inch)	Ø 15.88 (5/8)	Ø 15.88 (5/8)	Ø 15.88 (5/8)	Ø 15.88 (5/8)

Note : 1. Due to our policy of innovation some specifications may be changed without notification.
2. Definition of Power Input Nominal conditions - Performance tested under EN14511
3. Capacities are based on the following conditions:
Cooling : - Indoor Temperature 27°C DB / 19°C WB - Outdoor Temperature 35°C DB / 24°C WB Heating : - Indoor Temperature 20°C DB / 15°C WB - Outdoor Temperature 7°C DB / 6°C WB
4. Annual energy consumption : based on average use of 350 running hours in cooling and 1,400 hours in heating per year at seasonal condition
5. This product contains fluorinated greenhouse gases (R410A)

STANDARD INVERTER (R410A)

UT36
UT42
UT48
UT60



UU37W UU43W
UU49W UU61W



LG participates in the ECP programme for EUROVENT AC program.
Check ongoing validity of certification
:www.eurovent-certification.com



INDOOR				UT36 NN2	UT42 NM2	UT48 NM2	UT60 NM2
Capacity	Cooling	Min / Nom / Max	kW	4.0 / 10.0 / 11.0	5.0 / 12.5 / 13.8	5.5 / 13.9 / 15.7	5.9 / 14.6 / 16.3
	Heating	Min / Nom / Max	kW	4.4 / 11.0 / 12.1	5.0 / 14.0 / 15.4	6.4 / 15.3 / 17.6	6.8 / 16.9 / 18.7
Low Temperature Capacity	Heating -7°C	Max	kW	9.8	12.5	14.3	15.2
		Nom	kW	2.82	3.89	4.62	5.40
Power Input (Set)	Cooling	Nom	kW	3.09	3.88	4.49	5.50
	Heating	Nom	W	140	210	210	210
Power Input (Indoor)		Nom	W	140	210	210	210
Running Current	Cooling / Heating	Nom	A	4.1 / 4.5	5.6 / 5.6	6.7 / 6.5	7.8 / 8.0
Power Supply			Ø / V / Hz	1 / 220-240 / 50	1 / 220-240 / 50	1 / 220-240 / 50	1 / 220-240 / 50
EER				3.55	3.21	3.01	2.70
COP				3.56	3.61	3.41	3.07
SEER				5.41	5.40	5.40	5.30
SCOP				3.81	3.55	3.55	3.55
Pdesign (@ -10°C)			kW	7.6	12.8	12.8	12.8
Seasonal Energy Label	Cooling / Heating			A / A (A++ to E Scale)	-	-	-
Annual Energy Consumption	Cooling / Heating		kWh	648 / 2,800	-	-	-
Piping Connection	Liquid		mm (inch)	Ø 9.52 (3/8)	Ø 9.52 (3/8)	Ø 9.52 (3/8)	Ø 9.52 (3/8)
	Gas		mm (inch)	Ø 15.88 (5/8)	Ø 15.88 (5/8)	Ø 15.88 (5/8)	Ø 15.88 (5/8)
	Drain	O.D. / I.D.	mm	32 / 25	32 / 25	32 / 25	32 / 25
Air Flow Rate		High / Medium / Low	m³/min	24.0 / 22.0 / 19.0	30.0 / 28.0 / 26.0	34.0 / 32.0 / 30.0	34.0 / 32.0 / 30.0
Sound Pressure	Cooling	High / Medium / Low	dBA	43 / 40 / 37	46 / 44 / 43	49 / 47 / 45	49 / 47 / 45
Sound Power	Cooling	Max	dBA	62	65	66	66
Dehumidification Rate			l/h	2.7	3.6	4.4	5.5
Dimensions	Body	W x H x D	mm	840 x 246 x 840	840 x 288 x 840	840 x 288 x 840	840 x 288 x 840
Net Weight	Body		kg	22.3	24.6	24.6	24.6
Decoration Panel	Model			PT-UMC1	PT-UMC1	PT-UMC1	PT-UMC1
	Color			Morning Fog (RAL 120-4)	Morning Fog (RAL 120-4)	Morning Fog (RAL 120-4)	Morning Fog (RAL 120-4)
	Dimensions	W x H x D	mm	950 x 25 x 950	950 x 25 x 950	950 x 25 x 950	950 x 25 x 950
	Weight		kg	5.0	5.0	5.0	5.0

OUTDOOR				UU37W UO2	UU43W U32	UU49W U32	UU61W U32
Compressor	Type			Twin Rotary	Twin Rotary	Twin Rotary	Twin Rotary
Airflow Rate	Nom		m³/min	90	110	110	110
Sound Pressure	Cooling	Nom	dBA	53	52	52	52
	Heating	Nom	dBA	54	54	54	54
Sound Power	Cooling	Max	dBA	66	67	68	71
Dimensions	W x H x D		mm	950 x 1,170 x 330	950 x 1,380 x 330	950 x 1,380 x 330	950 x 1,380 x 330
Net Weight			kg	85.0	96.0	96.0	96.0
Refrigerant	Type			R410A	R410A	R410A	R410A
	Charge		g	2,800	3,400	3,400	3,400
	Additional Charge		g/m	40	40	40	40
	GWP			2087.5	2087.5	2087.5	2087.5
	TCO2eq			5.8	7.1	7.1	7.1
Operation Range (Outdoor)	Cooling	Min - Max	°C DB	-15 - 48	-15 - 48	-15 - 48	-15 - 48
	Heating	Min - Max	°C WB	-18 - 18	-18 - 18	-18 - 18	-18 - 18
Power Supply			Ø / V / Hz	3 / 380-415 / 50	3 / 380-415 / 50	3 / 380-415 / 50	3 / 380-415 / 50
Power Supply Cable			No. x mm²	5C x 2.5	5C x 2.5	5C x 2.5	5C x 2.5
Transmission Cable			No. x mm²	4C x 0.75	4C x 0.75	4C x 0.75	4C x 0.75
Circuit Breaker			A	20	20	20	20
Piping Length Total		Min - Max	m	5 - 50	5 - 75	5 - 75	5 - 75
Piping Elevation Difference	IDU - ODU	Max	m	30	30	30	30
Piping Connection	Liquid		mm (inch)	Ø 9.52 (3/8)	Ø 9.52 (3/8)	Ø 9.52 (3/8)	Ø 9.52 (3/8)
	Gas		mm (inch)	Ø 15.88 (5/8)	Ø 15.88 (5/8)	Ø 15.88 (5/8)	Ø 15.88 (5/8)

Note : 1. Due to our policy of innovation some specifications may be changed without notification.
2. Definition of Power Input Nominal conditions - Performance tested under EN14511
3. Capacities are based on the following conditions:
Cooling : - Indoor Temperature 27°C DB / 19°C WB - Outdoor Temperature 35°C DB / 24°C WB Heating : - Indoor Temperature 20°C DB / 15°C WB - Outdoor Temperature 7°C DB / 6°C WB
4. Annual energy consumption : based on average use of 350 running hours in cooling and 1,400 hours in heating per year at seasonal condition
5. This product contains fluorinated greenhouse gases (R410A)

CEILING CONCEALED DUCT



SINGLE SPLIT KEY FEATURES

CEILING CONCEALED DUCT

COMMERCIAL

E.S.P. (External Static Pressure) Control

This function easily controls volume of the air by a remote controller. The BLDC motor can control fan speed and air volume regardless of the external static pressure. Additional accessories are not required to control air flow.

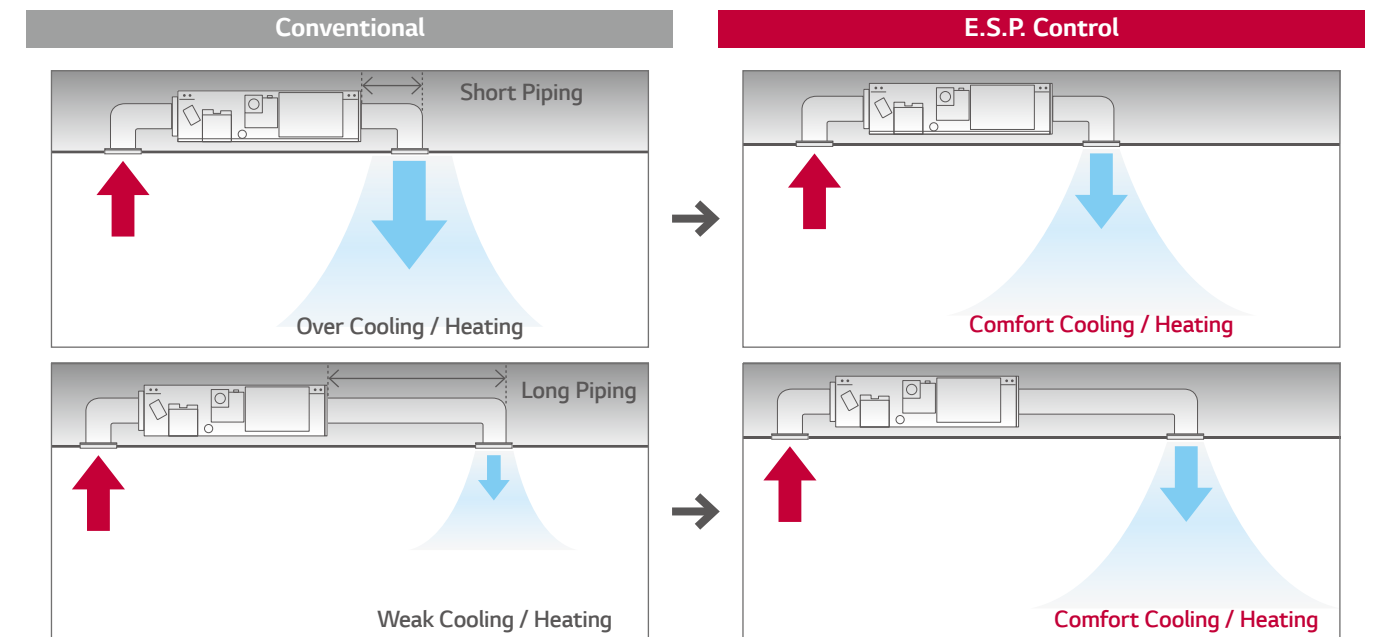

High Head Drain Pump

High head drain pump automatically drains water up to a height of 200mm of drain-head height. It provides the perfect solution for draining of water. (Standard Inverter : Accessory (ABDPG) / Low-Static Duct : Included)

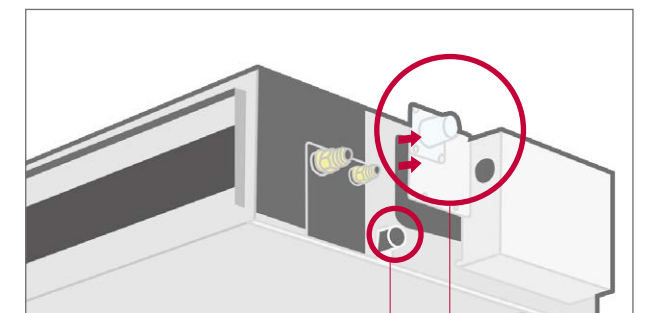
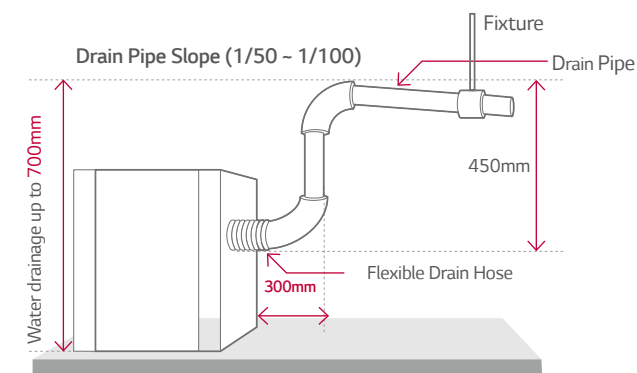

Available for Natural Drainage
Detachable Drain Pump

CEILING CONCEALED DUCT

Two Thermistors Control

The indoor temperature can be checked using the thermistors in the remote controller as well as from the indoor unit. There may be a significant difference between ceiling and floor air temperature. Two thermistors can optimise indoor air temperature for a more comfortable environment.

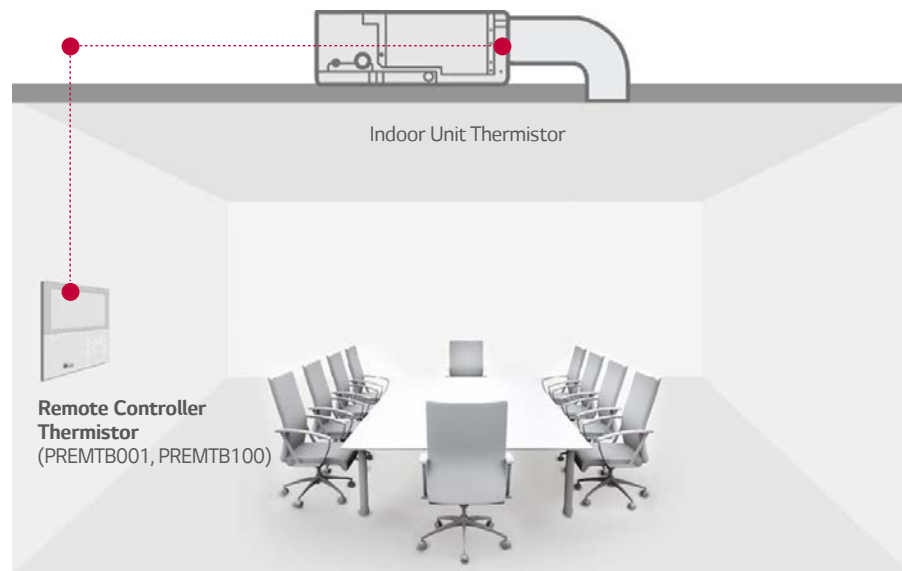

Compares temperatures sensed from different positions, and automatically selects the optimum temperature for users

Operation for Multiple Rooms

Using a spiral duct (Embedded or flexible type) and stream chamber, it is possible to operate cooling / heating for several rooms simultaneously. Also, zone control is available with zone controller accessory (ABZCA)

Zone control features

- Controls different zones (up to 4 zones) by external thermostat (AC a24V)
- Maintain proper air volume of each zone
- Auto variation of dampers
- Auto control of fan speed and On / Off operation

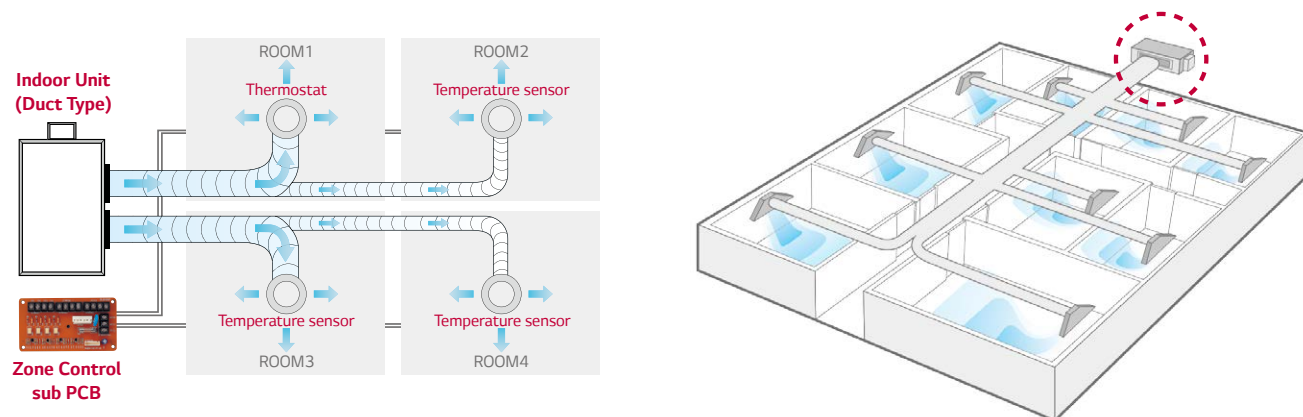

Minimized Height

New mid-static ducts provide ideal solution for installation in limited space.

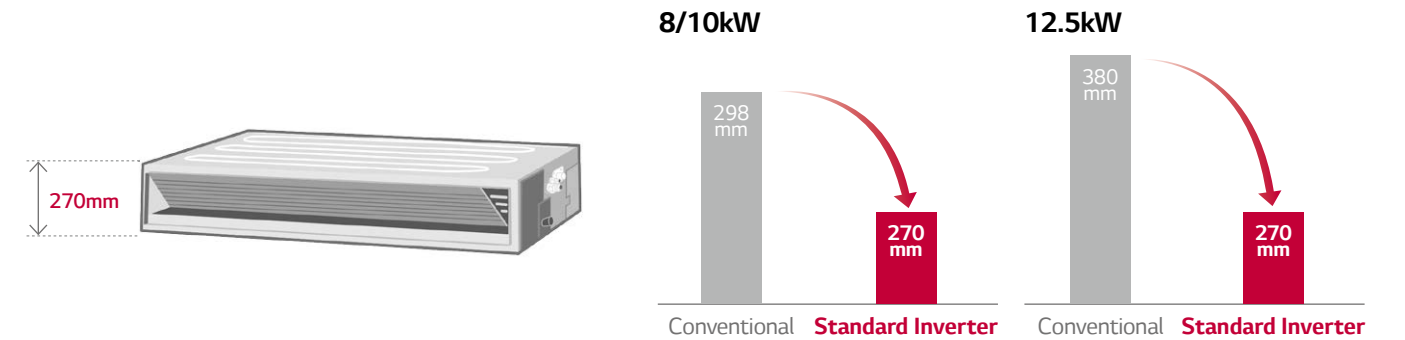

Wide Operation Range

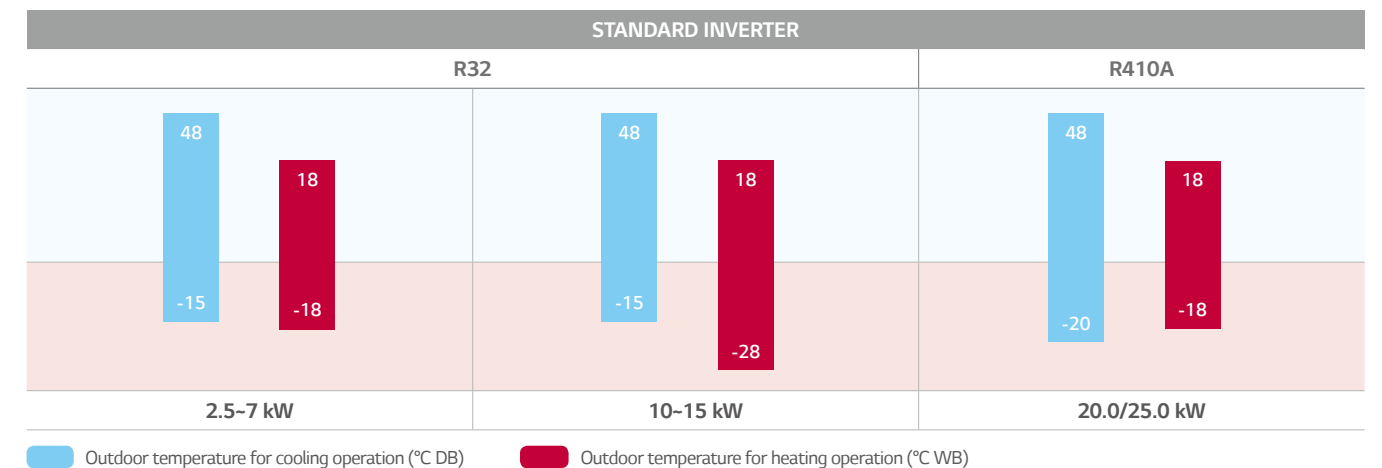

Easy Service & Maintenance

Users are not required to disassemble the whole panel for maintenance; since panel is divided into 2 components; one for heat exchanger and the other for fan/motor. The user can easily detach and re-attach the filter in the available limited space.

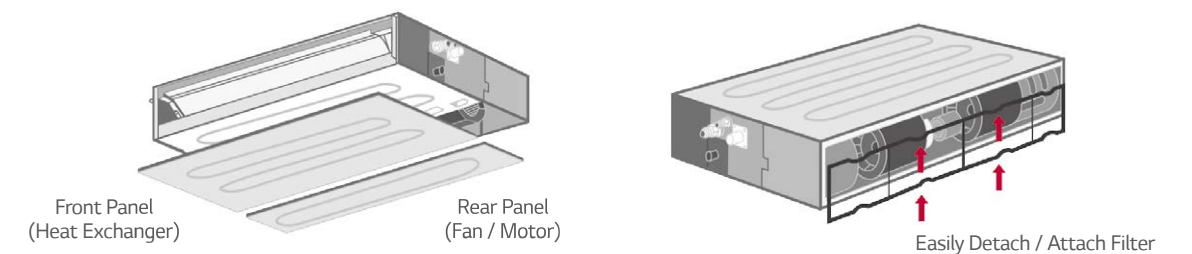

CEILING CONCEALED DUCT (LOW STATIC PRESSURE)

Quiet Operation

The noise level of low static ducts have been reduced, even though ESP has been increased.

	CL09R N20	CL12R N20	CL18R N20	CL24R N30
Sound Pressure (High / Medium / Low)	31 / 28 / 27	31 / 28 / 27	36 / 34 / 31	39 / 35 / 32

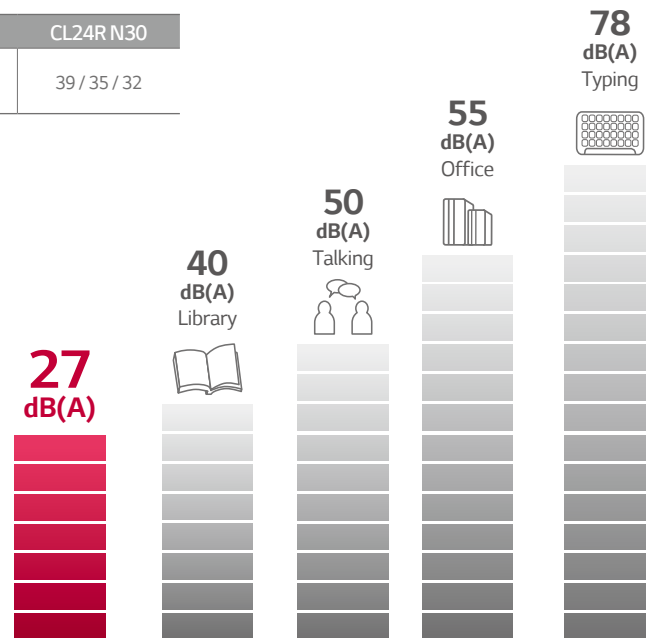

Flexible Installation

Standard Inverter low static duct allows the air intake at the rear or bottom under installation condition.

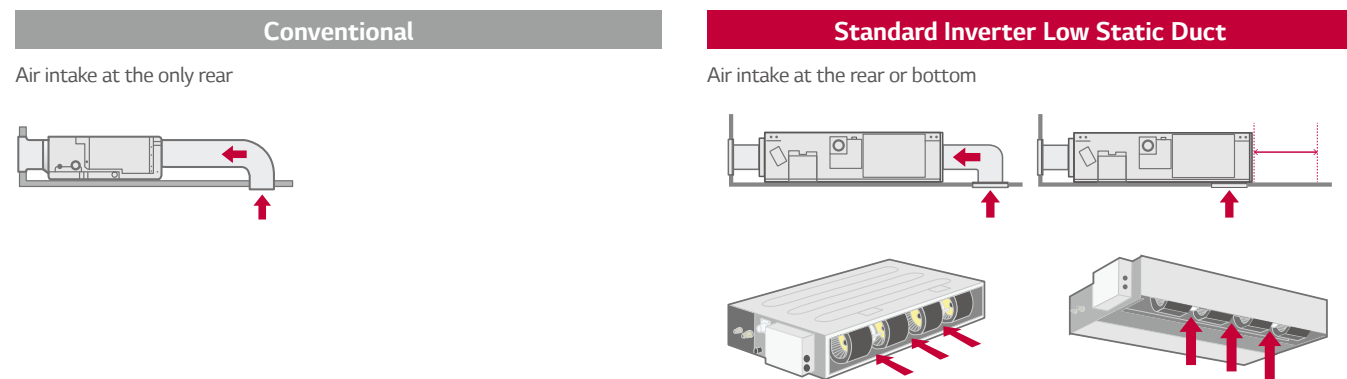

CEILING CONCEALED DUCT



STANDARD INVERTER (R32)

HIGH STATIC PRESSURE
- CM18R / CM24R



LG participates in the ECP programme for EUROVENT AC program. Check ongoing validity of certification : www.eurovent-certification.com

UU18WR

UU24WR



INDOOR				CM18R N10	CM24R N10
Capacity	Cooling	Min / Nom / Max	kW	1.8 / 5.0 / 6.0	2.8 / 6.8 / 7.8
	Heating	Min / Nom / Max	kW	2.2 / 6.0 / 7.2	3.2 / 7.5 / 8.3
Low Temperature Capacity	Heating -7°C	Max	kW	5.4	7.2
Power Input (Set)	Cooling	Nom	kW	1.46	2.03
	Heating	Nom	kW	1.60	2.20
Power Input (Indoor)	Min / Max (ESP 2.5mmAq)		W	50 / 80	50 / 90
	Min / Max (ESP 8.0mmAq)		W	90 / 160	100 / 180
Running Current	Cooling / Heating	Nom	A	6.5 / 7.1	9.0 / 9.8
Power Supply			Ø / V / Hz	1 / 220-240 / 50	1 / 220-240 / 50
EER				3.42	3.35
COP				3.74	3.40
SEER				6.30	6.81
SCOP				4.15	4.01
Pdesign (@-10°C)			kW	4.1	5.4
Seasonal Energy Label	Cooling / Heating (A++ to E Scale)			A++ / A+	A++ / A+
Annual Energy Consumption	Cooling / Heating		kWh	278 / 1,383	350 / 1,890
	Liquid		mm (inch)	Ø 6.35 (1/4)	Ø 9.52 (3/8)
Piping Connection	Gas		mm (inch)	Ø 2.7 (1/2)	Ø 15.88 (5/8)
	Drain	O.D. / I.D.	mm	32.0 / 25.0	32.0 / 25.0
Air Flow Rate		High / Medium / Low	m ³ /min	16.5 / 14.5 / 13.0	18.0 / 16.5 / 14.5
Sound Pressure	Cooling	High / Medium / Low	dB(A)	34 / 32 / 30	35 / 34 / 32
Sound Power	Cooling	Max	dB(A)	59	60
Dehumidification Rate			l/h	1.5	2.5
Dimensions	Body	W x H x D	mm	900 x 270 x 700	900 x 270 x 700
Net Weight	Body		kg	26.5	26.5
External Static Pressure		Min - Max	mmAq (Pa)	2.5-15 (25-147)	2.5-15 (25-147)

OUTDOOR				UU18WR U20	UU24WR U40
Compressor	Type			Twin Rotary	Twin Rotary
AirFlow Rate		Nom	m ³ /min	50	58
	Cooling	Nom	dB(A)	47	48
Sound Pressure	Heating	Nom	dB(A)	52	52
	Cooling	Max	dB(A)	63	67
Dimensions	W x H x D		mm	870 x 650 x 330	950 x 834 x 330
Net Weight			kg	44.8	56.1
Refrigerant	Type			R32	R32
	Charge		g	1,100	1,600
	Additional Charge (after 7.5m)		g/m	20	35
	GWP			675	675
	t-CO ₂ eq			0.74	1.08
Operation Range (Outdoor)	Cooling	Min - Max	°C DB	-15 - 48	-15 - 48
	Heating	Min - Max	°C WB	-18 - 18	-18 - 18
Power Supply			Ø / V / Hz	1 / 220-240 / 50	1 / 220-240 / 50
Power Supply Cable			No. x mm ²	3C x 2.5	3C x 2.5
Transmission Cable			No. x mm ²	4C x 0.75	4C x 0.75
Circuit Breaker			A	20	25
Piping Length Total		Min - Max	m	5 - 30	5 - 50
Piping Elevation Difference	IDU - ODU	Max	m	30	30
Piping Connection	Liquid		mm (inch)	Ø 6.35 (1/4)	Ø 9.52 (3/8)
	Gas		mm (inch)	Ø 12.7 (1/2)	Ø 15.88 (5/8)

Note: 1. Due to our policy of innovation some specifications may be changed without notification.
 2. Definition of Power Input Nominal conditions - Performance tested under EN14511
 3. Capacities are based on the following conditions:
 Cooling : - Indoor Temperature 27°C DB / 19°C WB - Outdoor Temperature 35°C DB / 24°C WB Heating : - Indoor Temperature 20°C DB / 15°C WB - Outdoor Temperature 7°C DB / 6°C WB
 4. Annual energy consumption : based on average use of 350 running hours in cooling and 1,400 hours in heating per year at seasonal condition
 5. This product contains fluorinated greenhouse gases (R32)

CEILING CONCEALED DUCT



STANDARD INVERTER (R32)

HIGH STATIC PRESSURE
- UM36R / UM42R / UM48R / UM60R



LG participates in the ECP programme for EUROVENT AC program.
Check ongoing validity of certification
:www.eurovent-certification.com

UU36WR UU42WR
UU48WR UU60WR



INDOOR				UM36R.N20	UM42R.N20	UM48R.N30	UM60R.N30	
Capacity	Cooling	Min / Nom / Max	kW	4.5 / 9.5 / 13.0	5.1 / 12.0 / 14.5	5.5 / 13.4 / 16.0	5.9 / 15.0 / 16.3	
	Heating	Min / Nom / Max	kW	5.0 / 10.8 / 13.7	5.5 / 13.5 / 16.5	6.1 / 15.5 / 18.0	6.8 / 16.8 / 18.7	
Low Temperature Capacity	Heating -7°C	Max	kW	10.0	12.5	14.8	15.2	
Power Input (Set)	Cooling	Nom	kW	2.43	3.45	4.00	4.75	
	Heating	Nom	kW	2.85	3.65	4.40	4.80	
Power Input (Indoor)			W	120 / 210	140 / 260	100 / 220	270 / 290	
			W	200 / 360	230 / 380	220 / 340	300 / 430	
Running Current	Cooling / Heating	Nom	A	10.6 / 12.4	15.0 / 15.9	17.4 / 19.1	20.7 / 20.9	
Power Supply			Ø / V / Hz	1 / 220-240 / 50	1 / 220-240 / 50	1 / 220-240 / 50	1 / 220-240 / 50	
EER				3.91	3.48	3.35	3.16	
COP				3.79	3.70	3.52	3.50	
SEER				5.62	5.50	5.51	5.45	
SCOP				4.04	4.00	3.96	3.92	
Pdesign (@-10°C)			kW	8.05	8.05	9.3	9.3	
Seasonal Energy Label	Cooling / Heating			A+ / A+ (A++ to E Scale)	A / A+	-	-	
Annual Energy Consumption	Cooling / Heating			kWh	594 / 2,800	764 / 2,800	1,459 / 3,288	1,651 / 3,321
	Liquid			mm (inch)	Ø 9.52 (3/8)	Ø 9.52 (3/8)	Ø 9.52 (3/8)	Ø 9.52 (3/8)
Piping Connection	Gas			mm (inch)	Ø 15.88 (5/8)	Ø 15.88 (5/8)	Ø 15.88 (5/8)	Ø 15.88 (5/8)
	Drain	O.D. / I.D.	mm	32 / 25	32 / 25	32 / 25	32 / 25	
Air Flow Rate			m ³ /min	32.0 / 28.0 / 24.0	38.0 / 33.0 / 28.0	40.0 / 34.0 / 28.0	50.0 / 45.0 / 40.0	
Sound Pressure	Cooling	High / Medium / Low	dBA	36 / 34 / 33	38 / 36 / 34	40 / 38 / 36	42 / 40 / 38	
Sound Power	Cooling	Max	dBA	60	62	65	66	
Dehumidification Rate			l/h	2.6	3.6	4.5	5.0	
Dimensions	Body	W x H x D	mm	1,250 x 270 x 700	1,250 x 270 x 700	1,250 x 360 x 700	1,250 x 360 x 700	
Net Weight	Body			kg	38.5	38.5	43.5	43.5
External Static Pressure			mmAq (Pa)	4-15 (39-147)	5-15 (49-147)	5-15 (49-147)	5-15 (49-147)	

OUTDOOR				UU36WR.U30	UU42WR.U30	UU48WR.U30	UU60WR.U30	
Compressor			Type	R-Scroll	R-Scroll	R-Scroll	R-Scroll	
Airflow Rate			Nom	m ³ /min	110	110	110	
Sound Pressure	Cooling	Nom	dBA	52	52	52	52	
	Heating	Nom	dBA	54	54	54	54	
Sound Power	Cooling	Max	dBA	66	67	68	68	
Dimensions			W x H x D	mm	950 x 1,380 x 330	950 x 1,380 x 330	950 x 1,380 x 330	
Net Weight			kg	87.5	87.5	87.5	87.5	
Refrigerant			Type	R32	R32	R32	R32	
			Charge	g	3,000	3,000	3,000	
			Additional Charge (after 7.5m)	g/m	40	40	40	
			GWP	675	675	675	675	
			t-CO ₂ eq	2.03	2.03	2.03	2.03	
Operation Range (Outdoor)	Cooling	Min ~ Max	°C DB	-15 ~ -48	-15 ~ -48	-15 ~ -48	-15 ~ -48	
	Heating	Min ~ Max	°C WB	-25 ~ -18	-25 ~ -18	-25 ~ -18	-25 ~ -18	
Power Supply			Ø / V / Hz	1 / 220-240 / 50	1 / 220-240 / 50	1 / 220-240 / 50	1 / 220-240 / 50	
Power Supply Cable			No. x mm ²	3C x 6.0	3C x 6.0	3C x 6.0	3C x 6.0	
Transmission Cable			No. x mm ²	4C x 0.75	4C x 0.75	4C x 0.75	4C x 0.75	
Circuit Breaker			A	40	40	40	40	
Piping Length Total			m	5-85	5-85	5-85	5-85	
Piping Elevation Difference	IDU - ODU	Max	m	30	30	30	30	
Piping Connection	Liquid			mm (inch)	Ø 9.52 (3/8)	Ø 9.52 (3/8)	Ø 9.52 (3/8)	Ø 9.52 (3/8)
	Gas			mm (inch)	Ø 15.88 (5/8)	Ø 15.88 (5/8)	Ø 15.88 (5/8)	Ø 15.88 (5/8)

Note : 1. Due to our policy of innovation some specifications may be changed without notification.
2. Definition of Power Input Nominal conditions - Performance tested under EN14511
3. Capacities are based on the following conditions:
Cooling : - Indoor Temperature 27°C DB / 19°C WB - Outdoor Temperature 35°C DB / 24°C WB Heating : - Indoor Temperature 20°C DB / 15°C WB - Outdoor Temperature 7°C DB / 6°C WB
4. Annual energy consumption : based on average use of 350 running hours in cooling and 1,400 hours in heating per year at seasonal condition
5. This product contains fluorinated greenhouse gases (R32)

STANDARD INVERTER (R32)

HIGH STATIC PRESSURE
- UM36R / UM42R / UM48R / UM60R



LG participates in the ECP programme for EUROVENT AC program.
Check ongoing validity of certification
:www.eurovent-certification.com

UU36WR UU42WR
UU49WR UU61WR



INDOOR				UM36R.N20	UM42R.N20	UM48R.N30	UM60R.N30	
Capacity	Cooling	Min / Nom / Max	kW	4.5 / 9.5 / 13.0	5.1 / 12.0 / 14.5	5.5 / 13.4 / 16.0	5.9 / 15.0 / 16.3	
	Heating	Min / Nom / Max	kW	5.0 / 10.8 / 13.7	5.5 / 13.5 / 16.5	6.1 / 15.5 / 18.0	6.8 / 16.8 / 18.7	
Low Temperature Capacity	Heating -7°C	Max	kW	10.0	12.5	14.8	15.2	
Power Input (Set)	Cooling	Nom	kW	2.43	3.45	4.00	4.75	
	Heating	Nom	kW	2.85	3.65	4.40	4.80	
Power Input (Indoor)			W	120 / 210	140 / 260	100 / 220	270 / 290	
			W	200 / 360	230 / 380	220 / 340	300 / 430	
Running Current	Cooling / Heating	Nom	A	3.5 / 4.1	5.0 / 5.3	5.8 / 6.4	6.9 / 6.9	
Power Supply			Ø / V / Hz	1 / 220-240 / 50	1 / 220-240 / 50	1 / 220-240 / 50	1 / 220-240 / 50	
EER				3.91	3.48	3.35	3.16	
COP				3.79	3.70	3.52	3.50	
SEER				5.60	5.50	5.51	5.45	
SCOP				4.00	4.00	3.96	3.92	
Pdesign (@-10°C)			kW	8.05	8.05	9.3	9.3	
Seasonal Energy Label	Cooling / Heating			A+ / A+ (A++ to E Scale)	A / A+	-	-	
Annual Energy Consumption	Cooling / Heating			kWh	594 / 2,800	764 / 2,800	1,459 / 3,288	1,651 / 3,321
	Liquid			mm (inch)	Ø 9.52 (3/8)	Ø 9.52 (3/8)	Ø 9.52 (3/8)	Ø 9.52 (3/8)
Piping Connection	Gas			mm (inch)	Ø 15.88 (5/8)	Ø 15.88 (5/8)	Ø 15.88 (5/8)	Ø 15.88 (5/8)
	Drain	O.D. / I.D.	mm	32 / 25	32 / 25	32 / 25	32 / 25	
Air Flow Rate			m ³ /min	32.0 / 28.0 / 24.0	38.0 / 33.0 / 28.0	40.0 / 34.0 / 28.0	50.0 / 45.0 / 40.0	
Sound Pressure	Cooling	High / Medium / Low	dBA	36 / 34 / 33	38 / 36 / 34	40 / 38 / 36	42 / 40 / 38	
Sound Power	Cooling	Max	dBA	60	62	65	66	
Dehumidification Rate			l/h	2.6	3.6	4.5	5.0	
Dimensions	Body	W x H x D	mm	1,250 x 270 x 700	1,250 x 270 x 700	1,250 x 360 x 700	1,250 x 360 x 700	
Net Weight	Body			kg	38.5	38.5	43.5	43.5
External Static Pressure			mmAq (Pa)	4-15 (39-147)	5-15 (49-147)	5-15 (49-147)	5-15 (49-147)	

OUTDOOR				UU37WR.U30	UU43WR.U30	UU49WR.U30	UU61WR.U30	
Compressor			Type	R-Scroll	R-Scroll	R-Scroll	R-Scroll	
Airflow Rate			Nom	m ³ /min	110	110	110	
Sound Pressure	Cooling	Nom	dBA	52	52	52	52	
	Heating	Nom	dBA	54	54	54	54	
Sound Power	Cooling	Max	dBA	66	67	68	68	
Dimensions			W x H x D	mm	950 x 1,380 x 330	950 x 1,380 x 330	950 x 1,380 x 330	
Net Weight			kg	87.5	87.5	87.5	87.5	
Refrigerant			Type	R32	R32	R32	R32	
			Charge	g	3,000	3,000	3,000	
			Additional Charge (after 7.5m)	g/m	40	40	40	
			GWP	675	675	675	675	
			t-CO ₂ eq	2.03	2.03	2.03	2.03	
Operation Range (Outdoor)	Cooling	Min ~ Max	°C DB	-15 ~ -48	-15 ~ -48	-15 ~ -48	-15 ~ -48	
	Heating	Min ~ Max	°C WB	-25 ~ -18	-25 ~ -18	-25 ~ -18	-25 ~ -18	
Power Supply			Ø / V / Hz	3 / 380-415 / 50	3 / 380-415 / 50	3 / 380-415 / 50	3 / 380-415 / 50	
Power Supply Cable			No. x mm ²	5C x 2.5	3C x 6.0	5C x 2.5	5C x 2.5	
Transmission Cable			No. x mm ²	4C x 0.75	4C x 0.75	4C x 0.75	4C x 0.75	
Circuit Breaker			A	20	40	20	20	
Piping Length Total			m	5-85	5-85	5-85	5-85	
Piping Elevation Difference	IDU - ODU	Max	m	30	30	30	30	
Piping Connection	Liquid			mm (inch)	Ø 9.52 (3/8)	Ø 9.52 (3/8)	Ø 9.52 (3/8)	Ø 9.52 (3/8)
	Gas			mm (inch)	Ø 15.88 (5/8)	Ø 15.88 (5/8)	Ø 15.88 (5/8)	Ø 15.88 (5/8)

Note : 1. Due to our policy of innovation some specifications may be changed without notification.
2. Definition of Power Input Nominal conditions - Performance tested under EN14511
3. Capacities are based on the following conditions:
Cooling : - Indoor Temperature 27°C DB / 19°C WB - Outdoor Temperature 35°C DB / 24°C WB Heating : - Indoor Temperature 20°C DB / 15°C WB - Outdoor Temperature 7°C DB / 6°C WB
4. Annual energy consumption : based on average use of 350 running hours in cooling and 1,400 hours in heating per year at seasonal condition
5. This product contains fluorinated greenhouse gases (R32)

CEILING CONCEALED DUCT



STANDARD INVERTER (R32)

LOW STATIC PRESSURE
- CL09R / CL12R / CL18R / CL24R



LG participates in the ECP programme for EUROVENT AC program.
Check ongoing validity of certification
:www.eurovent-certification.com

UU09WR
UU12WR



UU18WR



UU24WR



COMPACT INVERTER (R32)

HIGH STATIC PRESSURE
- CM18R / CM24R / CM30R



LG participates in the ECP programme for EUROVENT AC program.
Check ongoing validity of certification
:www.eurovent-certification.com

UU18WCR



UU24WCR
UU30WCR



INDOOR				CL09R N20	CL12R N20	CL18R N20	CL24R N30
Capacity	Cooling	Min / Nom / Max	kW	1.1 / 2.5 / 3.2	1.4 / 3.4 / 3.9	2.0 / 5.0 / 6.0	4.0 / 7.1 / 7.7
	Heating	Min / Nom / Max	kW	1.2 / 3.2 / 3.6	1.6 / 4.0 / 4.7	2.2 / 6.0 / 7.2	2.0 / 7.5 / 8.2
Low Temperature Capacity	Heating -7°C	Max	kW	3.5	4.4	6.7	8.2
Power Input (Set)	Cooling	Nom	kW	0.64	0.99	1.52	2.15
	Heating	Nom	kW	0.74	1.00	1.76	2.06
Power Input (Indoor)			W	80 / 95	80 / 95	95 / 120	90 / 150
			W	80 / 100	80 / 100	100 / 140	110 / 160
Running Current	Cooling / Heating	Nom	A	2.8 / 3.2	4.2 / 4.6	6.8 / 7.8	9.5 / 9.1
Power Supply			Ø / V / Hz	1 / 220-240 / 50	1 / 220-240 / 50	1 / 220-240 / 50	1 / 220-240 / 50
EER				3.90	3.42	3.30	3.30
COP				4.30	4.00	3.41	3.65
SEER				6.28	6.28	6.30	6.60
SCOP				4.00	4.00	3.95	4.20
Pdesign (@-10°C)			kW	3.0	3.0	4.1	5.4
Seasonal Energy Label	Cooling / Heating (A++ to E Scale)			A++ / A+	A++ / A+	A++ / A	A++ / A+
Annual Energy Consumption	Cooling / Heating		kWh	139 / 1,050	189 / 1,050	278 / 1,453	377 / 1,798
	Liquid		mm (inch)	Ø 6.35 (1/4)	Ø 6.35 (1/4)	Ø 6.35 (1/4)	Ø 9.52 (3/8)
Piping Connection	Gas		mm (inch)	Ø 9.52 (3/8)	Ø 9.52 (3/8)	Ø 12.7 (1/2)	Ø 15.88 (5/8)
	Drain		O.D. / I.D.	mm	32.0 / 25.0	32.0 / 25.0	32.0 / 25.0
Air Flow Rate	High / Medium / Low		m ³ /min	10.0 / 8.5 / 7.0	10.0 / 8.5 / 7.0	15.0 / 12.5 / 10.0	20.0 / 16.0 / 12.0
Sound Pressure	Cooling	High / Medium / Low	dBA	31 / 28 / 27	31 / 28 / 27	36 / 34 / 31	39 / 35 / 32
Sound Power	Cooling	Max	dBA	55	55	54	58
Dehumidification Rate			l/h	0.5	1.1	1.6	2.6
Dimensions	Body	W x H x D	mm	900 x 190 x 700	900 x 190 x 700	900 x 190 x 700	1,100 x 190 x 700
Net Weight	Body		kg	24.0	24.0	24.0	27.0
External Static Pressure	Min - Max		mmAq (Pa)	0-5 (0-49)	0-5 (0-49)	0-5 (0-49)	0-5 (0-49)

OUTDOOR				UU09WR ULO	UU12WR ULO	UU18WR U20	UU24WR U40
Compressor	Type			Twin Rotary	Twin Rotary	Twin Rotary	Twin Rotary
Airflow Rate	Nom		m ³ /min	32	32	50	58
Sound Pressure	Cooling	Nom	dBA	47	49	47	48
	Heating	Nom	dBA	50	52	52	52
Sound Power	Cooling	Max	dBA	65	65	63	67
Dimensions	W x H x D		mm	770 x 545 x 288	770 x 545 x 288	870 x 650 x 330	950 x 834 x 330
Net Weight			kg	33.8	33.8	44.8	56.1
Refrigerant	Type			R32	R32	R32	R32
	Charge		g	900	900	1,100	1,600
	Additional Charge (after 7.5m)		g/m	20	20	20	35
	GWP			675	675	675	675
	t-CO ₂ eq			0.61	0.61	0.74	1.08
Operation Range (Outdoor)	Cooling	Min - Max	°C DB	-15 - 48	-15 - 48	-15 - 48	-15 - 48
	Heating	Min - Max	°C WB	-18 - 18	-18 - 18	-18 - 18	-18 - 18
Power Supply			Ø / V / Hz	1 / 220-240 / 50	1 / 220-240 / 50	1 / 220-240 / 50	1 / 220-240 / 50
Power Supply Cable			No. x mm ²	3C x 2.5	3C x 2.5	3C x 2.5	3C x 2.5
Transmission Cable			No. x mm ²	4C x 0.75	4C x 0.75	4C x 0.75	4C x 0.75
Circuit Breaker			A	15	15	20	25
Piping Length Total	Min - Max		m	5-20	5-20	5-30	5-50
Piping Elevation Difference	IDU - ODU	Max	m	10	10	30	30
Piping Connection	Liquid		mm (inch)	Ø 6.35 (1/4)	Ø 6.35 (1/4)	Ø 6.35 (1/4)	Ø 9.52 (3/8)
	Gas		mm (inch)	Ø 9.52 (3/8)	Ø 9.52 (3/8)	Ø 12.7 (1/2)	Ø 15.88 (5/8)

Note : 1. Due to our policy of innovation some specifications may be changed without notification.
2. Definition of Power Input Nominal conditions - Performance tested under EN14511
3. Capacities are based on the following conditions:
Cooling : - Indoor Temperature 27°C DB / 19°C WB - Outdoor Temperature 35°C DB / 24°C WB Heating : - Indoor Temperature 20°C DB / 15°C WB - Outdoor Temperature 7°C DB / 6°C WB
4. Annual energy consumption : based on average use of 350 running hours in cooling and 1,400 hours in heating per year at seasonal condition
5. This product contains fluorinated greenhouse gases (R32)

INDOOR				CM18R N10	CM24R N10	CM30R N10
Capacity	Cooling	Min / Nom / Max	kW	1.8 / 5.0 / 5.3	2.7 / 6.8 / 7.4	3.0 / 7.5 / 8.2
	Heating	Min / Nom / Max	kW	1.7 / 5.2 / 6.0	1.9 / 7.5 / 8.2	2.0 / 8.0 / 8.4
Low Temperature Capacity	Heating -7°C	Max	kW	3.9	5.7	7.0
Power Input (Set)	Cooling	Nom	kW	1.67	2.27	2.34
	Heating	Nom	kW	1.58	2.40	2.28
Power Input (Indoor)			W	50 / 80	50 / 90	90 / 150
			W	90 / 160	100 / 180	160 / 240
Running Current	Cooling / Heating	Nom	A	7.4 / 7.0	10.2 / 10.6	10.6 / 10.0
Power Supply			Ø / V / Hz	1 / 220-240 / 50	1 / 220-240 / 50	1 / 220-240 / 50
EER				2.99	3.00	3.21
COP				3.29	3.13	3.51
SEER				5.60	5.60	5.88
SCOP				3.80	3.80	3.90
Pdesign (@-10°C)			kW	2.9	4.0	4.0
Seasonal Energy Label	Cooling / Heating (A++ to E Scale)			A+ / A	A+ / A	A+ / A
Annual Energy Consumption	Cooling / Heating		kWh	313 / 1,066	425 / 1,474	446 / 1,436
	Liquid		mm (inch)	Ø 6.35 (1/4)	Ø 9.52 (3/8)	Ø 9.52 (3/8)
Piping Connection	Gas		mm (inch)	Ø 12.7 (1/2)	Ø 15.88 (5/8)	Ø 15.88 (5/8)
	Drain		O.D. / I.D.	mm	32.0 / 25.0	32.0 / 25.0
Air Flow Rate	High / Medium / Low		m ³ /min	16.5 / 14.5 / 13.0	18.0 / 16.5 / 14.5	22.0 / 20.0 / 18.0
Sound Pressure	Cooling	High / Medium / Low	dBA	34 / 32 / 30	35 / 34 / 32	37 / 35 / 34
Sound Power	Cooling	Max	dBA	59	60	62
Dehumidification Rate			l/h	1.2	2.5	2.8
Dimensions	Body	W x H x D	mm	900 x 270 x 700	900 x 270 x 700	900 x 270 x 700
Net Weight	Body		kg	26.5	26.5	27.0
External Static Pressure	Min - Max		mmAq (Pa)	2.5-15 (25-147)	2.5-15 (25-147)	2.5-15 (25-147)

OUTDOOR				UU18WCR ULO	UU24WCR U20	UU30WCR U20
Compressor	Type			Twin Rotary	Twin Rotary	Twin Rotary
Airflow Rate	Nom		m ³ /min	32	50	50
Sound Pressure	Cooling	Nom	dBA	49	49	50
	Heating	Nom	dBA	52	53	54
Sound Power	Cooling	Max	dBA	65	65	67
Dimensions	W x H x D		mm	770 x 545 x 288	870 x 650 x 330	870 x 650 x 330
Net Weight			kg	35.9	45.0	45.0
Refrigerant	Type			R32	R32	R32
	Charge		g	1,000	1,300	1,300
	Additional Charge (after 7.5m)		g/m	20	20	20
	GWP			675	675	675
	t-CO ₂ eq			0.61	0.74	0.74
Operation Range (Outdoor)	Cooling	Min - Max	°C DB	-10 - 48	-10 - 48	-10 - 48
	Heating	Min - Max	°C WB	-10 - 18	-10 - 18	-10 - 18
Power Supply			Ø / V / Hz	1 / 220-240 / 50	1 / 220-240 / 50	1 / 220-240 / 50
Power Supply Cable			No. x mm ²	3C x 2.5	3C x 2.5	3C x 2.5
Transmission Cable			No. x mm ²	4C x 0.75	4C x 0.75	4C x 0.75
Circuit Breaker			A	15	20	20
Piping Length Total	Min - Max		m	5-30	5-35	5-35
Piping Elevation Difference	IDU - ODU	Max	m	30	30	30
Piping Connection	Liquid		mm (inch)	Ø 6.35 (1/4)	Ø 9.52 (3/8)	Ø 9.52 (3/8)
	Gas		mm (inch)	Ø 12.7 (1/2)	Ø 15.88 (5/8)	Ø 15.88 (5/8)

Note : 1. Due to our policy of innovation some specifications may be changed without notification.
2. Definition of Power Input Nominal conditions - Performance tested under EN14511
3. Capacities are based on the following conditions:
Cooling : - Indoor Temperature 27°C DB / 19°C WB - Outdoor Temperature 35°C DB / 24°C WB Heating : - Indoor Temperature 20°C DB / 15°C WB - Outdoor Temperature 7°C DB / 6°C WB
4. Annual energy consumption : based on average use of 350 running hours in cooling and 1,400 hours in heating per year at seasonal condition
5. This product contains fluorinated greenhouse gases (R32)

CEILING CONCEALED DUCT

STANDARD INVERTER (R410A)

MID / HIGH STATIC PRESSURE
- CM18 / CM24 / UM30



LG participates in the ECP programme for EUROVENT AC program.
Check ongoing validity of certification
:www.eurovent-certification.com

UU18W



UU24W
UU30W



INDOOR				CM18 N14	CM24 N14	UM30 N14
Capacity	Cooling	Min / Nom / Max	kW	1.8 / 5.0 / 6.0	2.8 / 6.8 / 7.5	3.2 / 7.8 / 8.8
	Heating	Min / Nom / Max	kW	2.2 / 6.0 / 7.2	3.2 / 7.5 / 8.3	3.6 / 9.0 / 9.9
Low Temperature Capacity	Heating -7°C	Max	kW	5.4	7.2	8.1
		Nom	kW	1.46	2.07	2.41
Power Input (Set)	Cooling	Nom	kW	1.66	2.34	2.62
	Heating	Nom	kW	1.66	2.34	2.62
Power Input (Indoor)		Min / Max (Nom ESP)	W	90 / 160	100 / 180	160 / 240
Running Current	Cooling / Heating	Nom	A	6.5 / 7.6	9.1 / 10.3	10.1 / 10.7
Power Supply		Ø / V / Hz		1 / 220-240 / 50	1 / 220-240 / 50	1 / 220-240 / 50
EER				3.41	3.11	3.51
COP				3.61	3.21	3.70
SEER				6.10	6.10	6.10
SCOP				4.25	3.90	4.00
Pdesign (@ -10°C)			kW	4.1	6.0	6.5
Seasonal Energy Label	Cooling / Heating (A++ to E Scale)			A++ / A+	A++ / A	A++ / A+
Annual Energy Consumption	Cooling / Heating		kWh	287 / 1,383	390 / 2,154	448 / 2,275
	Liquid		mm (inch)	Ø6.35 (1/4)	Ø9.52 (3/8)	Ø9.52 (3/8)
Piping Connection	Gas		mm (inch)	Ø12.7 (1/2)	Ø15.88 (5/8)	Ø15.88 (5/8)
	Drain	O.D. / I.D.	mm	32 / 25	32 / 25	32 / 25
	Air Flow Rate	High / Medium / Low	m³/min	16.5 / 14.5 / 13.0	18.0 / 16.5 / 14.5	22.0 / 20.0 / 18.0
Sound Pressure	Cooling	High / Medium / Low	dBA	34 / 32 / 30	35 / 34 / 32	37 / 35 / 34
Sound Power	Cooling	Max	dBA	59	60	62
Dehumidification Rate			l/h	2.0	2.5	2.8
Dimensions	Body	W x H x D	mm	900 x 270 x 700	900 x 270 x 700	900 x 270 x 700
Net Weight	Body		kg	23.8	24.2	25.3
External Static Pressure		Min - Max	mmAq (Pa)	2.5-15 (25-147)	2.5-15 (25-147)	2.5-15 (25-147)

OUTDOOR				UU18W UE4	UU24W U44	UU30W U44
Compressor	Type			Twin Rotary	Twin Rotary	Twin Rotary
Airflow Rate	Nom		m³/min	50	58	58
Sound Pressure	Cooling	Nom	dBA	47	48	48
	Heating	Nom	dBA	52	52	52
Sound Power	Cooling	Max	dBA	63	67	68
Dimensions	W x H x D		mm	870 x 655 x 320	950 x 834 x 330	950 x 834 x 330
Net Weight			kg	44.6	56.1	58.0
Refrigerant	Type			R410A	R410A	R410A
	Charge		g	1,300	2,000	2,000
	Additional Charge		g/m	20	40	40
	GWP			2087.5	2087.5	2087.5
	TCO2eq			2.7	4.2	4.2
Operation Range (Outdoor)	Cooling	Min - Max	°C DB	-15 - 48	-15 - 48	-15 - 48
	Heating	Min - Max	°C WB	-18 - 18	-18 - 18	-18 - 18
Power Supply			Ø / V / Hz	1 / 220-240 / 50	1 / 220-240 / 50	1 / 220-240 / 50
Power Supply Cable			No. x mm²	3C x 2.5	3C x 2.5	3C x 2.5
Transmission Cable			No. x mm²	4C x 0.75	4C x 0.75	4C x 0.75
Circuit Breaker			A	20	25	25
Piping Length Total		Min - Max	m	5 - 30	5 - 50	5 - 50
Piping Elevation Difference	IDU - ODU	Max	m	30	30	30
Piping Connection	Liquid		mm (inch)	Ø6.35 (1/4)	Ø9.52 (3/8)	Ø9.52 (3/8)
	Gas		mm (inch)	Ø12.7 (1/2)	Ø15.88 (5/8)	Ø15.88 (5/8)

Note : 1. Due to our policy of innovation some specifications may be changed without notification.
2. Definition of Power Input Nominal conditions - Performance tested under EN14511
3. Capacities are based on the following conditions:
Cooling : - Indoor Temperature 27°C DB / 19°C WB - Outdoor Temperature 35°C DB / 24°C WB Heating : - Indoor Temperature 20°C DB / 15°C WB - Outdoor Temperature 7°C DB / 6°C WB
4. Annual energy consumption : based on average use of 350 running hours in cooling and 1,400 hours in heating per year at seasonal condition
5. This product contains fluorinated greenhouse gases (R410A)

STANDARD INVERTER (R410A)

MID / HIGH STATIC PRESSURE
- UM36 / UM42 / UM48 / UM60



LG participates in the ECP programme for EUROVENT AC program.
Check ongoing validity of certification
:www.eurovent-certification.com

UU36W



UU42W
UU48W
UU60W



INDOOR				UM36 N24	UM42 N24	UM48 N34	UM60 N34
Capacity	Cooling	Min / Nom / Max	kW	4.0 / 10.0 / 11.0	5.0 / 12.1 / 13.2	5.6 / 14.0 / 15.4	5.9 / 14.8 / 16.3
	Heating	Min / Nom / Max	kW	4.5 / 11.2 / 12.3	5.6 / 14.0 / 15.0	6.6 / 15.8 / 18.2	6.8 / 16.8 / 18.7
Low Temperature Capacity	Heating -7°C	Max	kW	10.0	12.5	14.8	15.2
		Nom	kW	3.12	3.76	4.10	4.53
Power Input (Set)	Cooling	Nom	kW	3.12	3.76	4.10	4.53
	Heating	Nom	kW	3.19	3.86	4.39	4.79
Power Input (Indoor)		Min / Max (Nom ESP)	W	200 / 360	230 / 380	220 / 340	300 / 430
Running Current	Cooling / Heating	Nom	A	13.6 / 13.9	16.6 / 17.2	17.3 / 18.5	19.1 / 20.2
Power Supply		Ø / V / Hz		1 / 220-240 / 50	1 / 220-240 / 50	1 / 220-240 / 50	1 / 220-240 / 50
EER				3.21	3.22	3.41	3.31
COP				3.51	3.63	3.60	3.51
SEER				5.11	5.10	5.20	5.10
SCOP				3.81	3.58	3.65	3.65
Pdesign (@ -10°C)			kW	7.8	11.5	12.0	12.0
Seasonal Energy Label	Cooling / Heating (A++ to E Scale)			A / A (A++ to E Scale)	-	-	-
Annual Energy Consumption	Cooling / Heating		kWh	685 / 2,866	-	-	-
	Liquid		mm (inch)	Ø9.52 (3/8)	Ø9.52 (3/8)	Ø9.52 (3/8)	Ø9.52 (3/8)
Piping Connection	Gas		mm (inch)	Ø15.88 (5/8)	Ø15.88 (5/8)	Ø15.88 (5/8)	Ø15.88 (5/8)
	Drain	O.D. / I.D.	mm	32 / 25	32 / 25	32 / 25	32 / 25
	Air Flow Rate	High / Medium / Low	m³/min	32.0 / 28.0 / 24.0	38.0 / 33.0 / 28.0	40.0 / 34.0 / 28.0	50.0 / 45.0 / 40.0
Sound Pressure	Cooling	High / Medium / Low	dBA	36 / 34 / 33	38 / 36 / 34	40 / 38 / 36	42 / 40 / 38
Sound Power	Cooling	Max	dBA	60	62	65	66
Dehumidification Rate			l/h	3.2	3.6	4.5	5.0
Dimensions	Body	W x H x D	mm	1,250 x 270 x 700	1,250 x 270 x 700	1,250 x 360 x 700	1,250 x 360 x 700
Net Weight	Body		kg	35.0	37.0	42.5	42.5
External Static Pressure		Min - Max	mmAq (Pa)	4-15 (39-147)	5-15 (49-147)	5-15 (49-147)	5-15 (49-147)

OUTDOOR				UU36W U02	UU42W U32	UU48W U32	UU60W U32
Compressor	Type			Twin Rotary	Twin Rotary	Twin Rotary	Twin Rotary
Airflow Rate	Nom		m³/min	90	110	110	110
Sound Pressure	Cooling	Nom	dBA	53	52	52	52
	Heating	Nom	dBA	54	54	54	54
Sound Power	Cooling	Max	dBA	66	67	68	71
Dimensions	W x H x D		mm	950 x 1,170 x 330	950 x 1,380 x 330	950 x 1,380 x 330	950 x 1,380 x 330
Net Weight			kg	81.0	92.0	92.0	92.0
Refrigerant	Type			R410A	R410A	R410A	R410A
	Charge		g	2,800	3,400	3,400	3,400
	Additional Charge		g/m	40	40	40	40
	GWP			2087.5	2087.5	2087.5	2087.5
	TCO2eq			5.8	7.1	7.1	7.1
Operation Range (Outdoor)	Cooling	Min - Max	°C DB	-15 - 48	-15 - 48	-15 - 48	-15 - 48
	Heating	Min - Max	°C WB	-18 - 18	-18 - 18	-18 - 18	-18 - 18
Power Supply			Ø / V / Hz	1 / 220-240 / 50	1 / 220-240 / 50	1 / 220-240 / 50	1 / 220-240 / 50
Power Supply Cable			No. x mm²	3C x 5.0	3C x 5.0	3C x 5.0	3C x 5.0
Transmission Cable			No. x mm²	4C x 0.75	4C x 0.75	4C x 0.75	4C x 0.75
Circuit Breaker			A	40	40	40	40
Piping Length Total		Min - Max	m	5 - 50	5 - 75	5 - 75	5 - 75
Piping Elevation Difference	IDU - ODU	Max	m	30	30	30	30
Piping Connection	Liquid		mm (inch)	Ø9.52 (3/8)	Ø9.52 (3/8)	Ø9.52 (3/8)	Ø9.52 (3/8)
	Gas		mm (inch)	Ø15.88 (5/8)	Ø15.88 (5/8)	Ø15.88 (5/8)	Ø15.88 (5/8)

Note : 1. Due to our policy of innovation some specifications may be changed without notification.
2. Definition of Power Input Nominal conditions - Performance tested under EN14511
3. Capacities are based on the following conditions:
Cooling : - Indoor Temperature 27°C DB / 19°C WB - Outdoor Temperature 35°C DB / 24°C WB Heating : - Indoor Temperature 20°C DB / 15°C WB - Outdoor Temperature 7°C DB / 6°C WB
4. Annual energy consumption : based on average use of 350 running hours in cooling and 1,400 hours in heating per year at seasonal condition
5. This product contains fluorinated greenhouse gases (R410A)

CEILING CONCEALED DUCT

STANDARD INVERTER (R410A)

MID / HIGH STATIC PRESSURE
- UM36 / UM42 / UM48 / UM60



LG participates in the ECP programme for EUROVENT AC program.
Check ongoing validity of certification
:www.eurovent-certification.com



INDOOR				UM36 N24	UM42 N24	UM48 N34	UM60 N34
Capacity	Cooling	Min / Nom / Max	kW	4.0 / 10.0 / 11.0	5.0 / 12.5 / 13.8	5.6 / 14.0 / 15.4	5.9 / 14.8 / 16.3
	Heating	Min / Nom / Max	kW	4.5 / 11.2 / 12.3	5.6 / 14.0 / 15.4	6.6 / 16.4 / 18.2	6.8 / 16.8 / 18.7
Low Temperature Capacity	Heating -7°C	Max	kW	10.0	12.5	14.8	15.2
Power Input (Set)	Cooling	Nom	kW	3.12	3.76	4.10	4.53
	Heating	Nom	kW	3.19	3.86	4.39	4.79
Power Input (Indoor)		Min / Max (Nom ESP)	W	200 / 360	230 / 380	220 / 340	300 / 430
Running Current	Cooling / Heating	Nom	A	4.7 / 4.9		6.0 / 6.5	6.6 / 7.1
Power Supply		Ø / V / Hz		1 / 220-240 / 50	1 / 220-240 / 50	1 / 220-240 / 50	1 / 220-240 / 50
EER				3.21	3.22	3.41	3.31
COP				3.51	3.63	3.60	3.51
SEER				5.11	5.10	5.20	5.10
SCOP				3.81	3.58	3.65	3.65
Pdesign (@ -10°C)			kW	7.8	11.5	12.0	12.0
Seasonal Energy Label	Cooling / Heating			A / A (A++ to E Scale)	-	-	-
Annual Energy Consumption	Cooling / Heating		kWh	685 / 2,866	-	-	-
Piping Connection	Liquid		mm (inch)	Ø9.52 (3/8)	Ø9.52 (3/8)	Ø9.52 (3/8)	Ø9.52 (3/8)
	Gas		mm (inch)	Ø15.88 (5/8)	Ø15.88 (5/8)	Ø15.88 (5/8)	Ø15.88 (5/8)
	Drain	O.D. / I.D.	mm	32 / 25	32 / 25	32 / 25	32 / 25
Air Flow Rate	High / Medium / Low		m³/min	32.0 / 28.0 / 24.0	38.0 / 33.0 / 28.0	40.0 / 34.0 / 28.0	50.0 / 45.0 / 40.0
Sound Pressure	Cooling	High / Medium / Low	dBA	36 / 34 / 33	38 / 36 / 34	40 / 38 / 36	42 / 40 / 38
Sound Power	Cooling	Max	dBA	58	62	65	66
Dehumidification Rate			l/h	2.6	3.6	4.5	5.0
Dimensions	Body	W x H x D	mm	1,250 x 270 x 700	1,250 x 270 x 700	1,250 x 360 x 700	1,250 x 360 x 700
Net Weight	Body		kg	35.0	37.0	42.5	42.5
External Static Pressure		Min - Max	mmAq (Pa)	4-15 (39-147)	5-15 (49-147)	5-15 (49-147)	5-15 (49-147)

OUTDOOR				UU37W U02	UU43W U32	UU49W U32	UU61W U32
Compressor	Type			Twin Rotary	Twin Rotary	Twin Rotary	Twin Rotary
Airflow Rate	Nom		m³/min	90	110	110	110
Sound Pressure	Cooling	Nom	dBA	53	52	52	52
	Heating	Nom	dBA	54	54	54	54
Sound Power	Cooling	Max	dBA	66	67	68	71
Dimensions	W x H x D		mm	950 x 1,170 x 330	950 x 1,380 x 330	950 x 1,380 x 330	950 x 1,380 x 330
Net Weight			kg	85.0	96.0	96.0	96.0
Refrigerant	Type			R410A	R410A	R410A	R410A
	Charge		g	2,800	3,400	3,400	3,400
	Additional Charge		g/m	40	40	40	40
	GWP			2087.5	2087.5	2087.5	2087.5
	TCO2eq			5.8	7.1	7.1	7.1
Operation Range (Outdoor)	Cooling	Min - Max	°C DB	-15 - 48	-15 - 48	-15 - 48	-15 - 48
	Heating	Min - Max	°C WB	-18 - 18	-18 - 18	-18 - 18	-18 - 18
Power Supply			Ø / V / Hz	3 / 380-415 / 50	3 / 380-415 / 50	3 / 380-415 / 50	3 / 380-415 / 50
Power Supply Cable			No. x mm²	5C x 2.5	5C x 2.5	5C x 2.5	5C x 2.5
Transmission Cable			No. x mm²	4C x 0.75	4C x 0.75	4C x 0.75	4C x 0.75
Circuit Breaker			A	20	20	20	20
Piping Length Total		Min - Max	m	5 - 50	5 - 75	5 - 75	5 - 75
Piping Elevation Difference	IDU - ODU	Max	m	30	30	30	30
Piping Connection	Liquid		mm (inch)	Ø9.52 (3/8)	Ø9.52 (3/8)	Ø9.52 (3/8)	Ø9.52 (3/8)
	Gas		mm (inch)	Ø15.88 (5/8)	Ø15.88 (5/8)	Ø15.88 (5/8)	Ø15.88 (5/8)

Note : 1. Due to our policy of innovation some specifications may be changed without notification.
2. Definition of Power Input Nominal conditions - Performance tested under EN14511
3. Capacities are based on the following conditions:
Cooling : - Indoor Temperature 27°C DB / 19°C WB - Outdoor Temperature 35°C DB / 24°C WB Heating : - Indoor Temperature 20°C DB / 15°C WB - Outdoor Temperature 7°C DB / 6°C WB
4. Annual energy consumption : based on average use of 350 running hours in cooling and 1,400 hours in heating per year at seasonal condition
5. This product contains fluorinated greenhouse gases (R410A)

STANDARD INVERTER (R410A)

HIGH STATIC PRESSURE
- UB70 / UB85



LG participates in the ECP programme for EUROVENT AC program.
Check ongoing validity of certification
:www.eurovent-certification.com



INDOOR				UB70 N94	UB85 N94
Capacity	Cooling	Min / Nom / Max	kW	7.6 / 19.0 / 20.9	9.2 / 23.0 / 25.3
	Heating	Min / Nom / Max	kW	9.0 / 22.4 / 24.6	10.8 / 27.0 / 29.7
Low Temperature Capacity	Heating -7°C	Max	kW	18.0	24.0
Power Input (Set)	Cooling	Nom	kW	6.69	8.19
	Heating	Nom	kW	6.4	8.31
Power Input (Indoor)		Min / Max (Nom ESP)	W	550 / 760	610 / 920
Running Current	Cooling / Heating	Nom	A	11.5 / 10.7	13.5 / 13.6
Power Supply		Ø / V / Hz		1 / 220-240 / 50	1 / 220-240 / 50
EER				2.84	2.81
COP				3.50	3.25
SEER				4.60	4.80
SCOP				3.53	3.51
Pdesign (@ -10°C)			kW	13.4	18.5
Seasonal Energy Label	Cooling / Heating			-	-
Annual Energy Consumption	Cooling / Heating		kWh	-	-
Piping Connection	Liquid		mm (inch)	Ø9.52 (3/8)	Ø12.7 (1/2)
	Gas		mm (inch)	Ø25.4 (1/1)	Ø22.2 (7/8)
	Drain	O.D. / I.D.	mm	32 / 25	32 / 25
Air Flow Rate	High / Medium / Low		m³/min	70.0 / 65.0 / 60.0	80.0 / 72.0 / 64.0
Sound Pressure	Cooling	High / Medium / Low	dBA	43 / 41 / 40	43 / 41 / 40
Sound Power	Cooling	Max	dBA	61	61
Dehumidification Rate			l/h	1.81 (4.2)	5.14 (11.9)
Dimensions	Body	W x H x D	mm	1,563 x 458 x 791	1,563 x 458 x 791
Net Weight	Body		kg	90.0	90.0
External Static Pressure		Min - Max	mmAq (Pa)	6 - 25 (60-250)	6 - 25 (60-250)

OUTDOOR				UU70W U34	UU85W U74
Compressor	Type			Hermetically Sealed Scroll	Hermetically Sealed Scroll
Airflow Rate	Nom		m³/min	110	190
Sound Pressure	Cooling	Nom	dBA	55	59
	Heating	Nom	dBA	58	60
Sound Power	Cooling	Max	dBA	73	74
Dimensions	W x H x D		mm	950 x 1,380 x 330	1,090 x 1,625 x 380
Net Weight			kg	110	144.0
Refrigerant	Type			R410A	R410A
	Charge		g	5,200	5,500
	Additional Charge		g/m	70	70
	GWP			2087.5	2087.5
	TCO2eq			10.9	11.5
Operation Range (Outdoor)	Cooling	Min - Max	°C DB	-20 - 48	-20 - 48
	Heating	Min - Max	°C WB	-18 - 18	-18 - 18
Power Supply			Ø / V / Hz	3 / 380-415 / 50	3 / 380-415 / 50
Power Supply Cable			No. x mm²	3C x 2.5	5C x 2.5
Transmission Cable			No. x mm²	4C x 1.0	4C x 1.0
Circuit Breaker			A	30	30
Piping Length Total		Min - Max	m	75	75
Piping Elevation Difference	IDU - ODU	Max	m	30	30
Piping Connection	Liquid		mm (inch)	Ø9.53 (3/8)	Ø12.7 (1/2)
	Gas		mm (inch)	Ø25.4 (1/1)	Ø22.2 (7/8)

Note : 1. Due to our policy of innovation some specifications may be changed without notification.
2. Definition of Power Input Nominal conditions - Performance tested under EN14511
3. Capacities are based on the following conditions:
Cooling : - Indoor Temperature 27°C DB / 19°C WB - Outdoor Temperature 35°C DB / 24°C WB Heating : - Indoor Temperature 20°C DB / 15°C WB - Outdoor Temperature 7°C DB / 6°C WB
4. Annual energy consumption : based on average use of 350 running hours in cooling and 1,400 hours in heating per year at seasonal condition
5. This product contains fluorinated greenhouse gases (R410A)

CEILING CONCEALED DUCT

STANDARD INVERTER (R410A)

LOW STATIC PRESSURE
- CB09L / CB12L



LG participates in the ECP programme for EUROVENT AC program.
Check ongoing validity of certification
:www.eurovent-certification.com

UU09W
UU12W



INDOOR				CB09L N12	CB12L N22
Capacity	Cooling	Min / Nom / Max	kW	1.1 / 2.5 / 3.2	1.4 / 3.4 / 3.7
	Heating	Min / Nom / Max	kW	1.2 / 3.2 / 3.6	1.6 / 4.0 / 4.5
Low Temperature Capacity	Heating -7°C	Max	kW	3.5	4.4
		Power Input (Set)	Cooling	Nom	kW
Power Input (Set)	Heating	Nom	kW	0.91	1.05
		Power Input (Indoor)	Min / Max (Nom ESP)	W	40 / 60
Running Current	Cooling / Heating	Nom	A	3.1 / 4.0	4.3 / 4.6
Power Supply			Ø / V / Hz	1 / 220-240 / 50	1 / 220-240 / 50
EER				3.48	3.41
COP				3.51	3.81
SEER				5.11	5.61
SCOP				3.81	3.81
Pdesign (@ -10°C)			kW	2.8	3.0
Seasonal Energy Label	Cooling / Heating (A++ to E Scale)			A / A	A+ / A
Annual Energy Consumption	Cooling / Heating		kWh	172 / 1,032	213 / 1,105
	Piping Connection	Liquid	mm (inch)	Ø6.35 (1/4)	Ø6.35 (1/4)
Gas		mm (inch)	Ø9.52 (3/8)	Ø9.52 (3/8)	
Drain		O.D. / I.D.	mm	32 / 25	32 / 25
Air Flow Rate	High / Medium / Low		m³/min	9.0 / 7.0 / 5.5	10.0 / 8.5 / 7.0
Sound Pressure	Cooling	High / Medium / Low	dBA	30 / 26 / 23	31 / 28 / 27
Sound Power	Cooling	Max	dBA	49	52
Dehumidification Rate			l/h	1.1	1.2
Dimensions	Body	W x H x D	mm	700 x 190 x 700	900 x 190 x 700
Net Weight	Body		kg	17.5	23.0
External Static Pressure	Min - Max		mmAq (Pa)	0-5 (0-49)	0-5 (0-49)

OUTDOOR				UU09W ULD	UU12W ULD
Compressor	Type			Rotary	Rotary
Airflow Rate	Nom		m³/min	32	32
Sound Pressure	Cooling		Nom	dBA	47
	Heating		Nom	dBA	48
Sound Power	Cooling		Max	dBA	56
Dimensions	W x H x D		mm	770 x 540 x 245	770 x 540 x 245
	Net Weight		kg	32.0	32.0
Refrigerant	Type			R410A	R410A
	Charge		g	1,000	1,000
	Additional Charge		g/m	20	20
	GWP			2,087.5	2,087.5
	TCO2eq			2.1	2.1
Operation Range (Outdoor)	Cooling	Min - Max	°C DB	-10 - 43	-10 - 43
	Heating	Min - Max	°C WB	-18 - 18	-18 - 18
Power Supply			Ø / V / Hz	1 / 220-240 / 50	1 / 220-240 / 50
Power Supply Cable			No.xmm²	3C x 2.5	3C x 2.5
Transmission Cable			No.xmm²	4C x 0.75	4C x 0.75
Circuit Breaker			A	15	15
Piping Length Total	Min - Max		m	5-15	5-15
Piping Elevation Difference	IDU - ODU	Max	m	10	10
Piping Connection	Liquid		mm (inch)	Ø6.35 (1/4)	Ø6.35 (1/4)
	Gas		mm (inch)	Ø9.52 (3/8)	Ø9.52 (3/8)

Note : 1. Due to our policy of innovation some specifications may be changed without notification.
2. Definition of Power Input Nominal conditions - Performance tested under EN14511
3. Capacities are based on the following conditions:
Cooling : - Indoor Temperature 27°C DB / 19°C WB - Outdoor Temperature 35°C DB / 24°C WB Heating : - Indoor Temperature 20°C DB / 15°C WB - Outdoor Temperature 7°C DB / 6°C WB
4. Annual energy consumption : based on average use of 350 running hours in cooling and 1,400 hours in heating per year at seasonal condition
5. This product contains fluorinated greenhouse gases (R410A)

STANDARD INVERTER (R410A)

LOW STATIC PRESSURE
- CB18L / CB24L



LG participates in the ECP programme for EUROVENT AC program.
Check ongoing validity of certification
:www.eurovent-certification.com

UU18W UU24W



INDOOR				CB18L N22	CB24L N32
Capacity	Cooling	Min / Nom / Max	kW	2.0 / 5.0 / 6.0	4.0 / 7.1 / 7.7
	Heating	Min / Nom / Max	kW	2.2 / 6.0 / 7.2	2.0 / 7.5 / 8.3
Low Temperature Capacity	Heating -7°C	Max	kW	6.7	8.2
		Power Input (Set)	Cooling	Nom	kW
Power Input (Set)	Heating	Nom	kW	1.50	2.05
		Power Input (Indoor)	Min / Max (Nom ESP)	W	100 / 140
Running Current	Cooling / Heating	Nom	A	6.8 / 8.4	10.4 / 9.0
Power Supply			Ø / V / Hz	1 / 220-240 / 50	1 / 220-240 / 50
EER				3.11	3.01
COP				3.41	3.61
SEER				6.10	5.60
SCOP				3.95	3.90
Pdesign (@ -10°C)			kW	4.0	5.8
Seasonal Energy Label	Cooling / Heating (A++ to E Scale)			A++ / A	A+ / A
Annual Energy Consumption	Cooling / Heating		kWh	287 / 1,418	444 / 2,082
	Piping Connection	Liquid	mm (inch)	Ø6.35 (1/4)	Ø9.52 (3/8)
Gas		mm (inch)	Ø12.7 (1/2)	Ø15.88 (5/8)	
Drain		O.D. / I.D.	mm	32 / 25	32 / 25
Air Flow Rate	High / Medium / Low		m³/min	15.0 / 12.5 / 10.0	20.0 / 16.0 / 12.0
Sound Pressure	Cooling	High / Medium / Low	dBA	36 / 34 / 31	39 / 35 / 32
Sound Power	Cooling	Max	dBA	54	58
Dehumidification Rate			l/h	1.7	2.2
Dimensions	Body	W x H x D	mm	900 x 190 x 700	1,100 x 190 x 700
Net Weight	Body		kg	23.0	27.0
External Static Pressure	Min - Max		mmAq (Pa)	0-5 (0-49)	0-5 (0-49)

OUTDOOR				UU18W UE4	UU24W U44
Compressor	Type			Twin Rotary	Twin Rotary
Airflow Rate	Nom		m³/min	50	58
Sound Pressure	Cooling		Nom	dBA	47
	Heating		Nom	dBA	52
Sound Power	Cooling		Max	dBA	63
Dimensions	W x H x D		mm	870 x 655 x 320	950 x 834 x 330
	Net Weight		kg	44.8	56.1
Refrigerant	Type			R410A	R410A
	Charge		g	1,300	2,000
	Additional Charge		g/m	20	40
	GWP			2,087.5	2,087.5
	TCO2eq			2.7	4.2
Operation Range (Outdoor)	Cooling	Min - Max	°C DB	-15 - 48	-15 - 48
	Heating	Min - Max	°C WB	-18 - 18	-18 - 18
Power Supply			Ø / V / Hz	1 / 220-240 / 50	1 / 220-240 / 50
Power Supply Cable			No.xmm²	3C x 2.5	3C x 2.5
Transmission Cable			No.xmm²	4C x 0.75	4C x 0.75
Circuit Breaker			A	20	25
Piping Length Total	Min - Max		m	5 - 30	5 - 50
Piping Elevation Difference	IDU - ODU	Max	m	30	30
Piping Connection	Liquid		mm (inch)	Ø6.35 (1/4)	Ø9.52 (3/8)
	Gas		mm (inch)	Ø12.7 (1/2)	Ø15.88 (5/8)

Note : 1. Due to our policy of innovation some specifications may be changed without notification.
2. Definition of Power Input Nominal conditions - Performance tested under EN14511
3. Capacities are based on the following conditions:
Cooling : - Indoor Temperature 27°C DB / 19°C WB - Outdoor Temperature 35°C DB / 24°C WB Heating : - Indoor Temperature 20°C DB / 15°C WB - Outdoor Temperature 7°C DB / 6°C WB
4. Annual energy consumption : based on average use of 350 running hours in cooling and 1,400 hours in heating per year at seasonal condition
5. This product contains fluorinated greenhouse gases (R410A)

SINGLE SPLIT SPECIFICATION

CEILING CONCEALED DUCT

COMPACT INVERTER (R410A)

HIGH STATIC PRESSURE
- UB18C / UB24C / UM30 / UM36



LG participates in the ECP programme for EUROVENT AC program.
Check ongoing validity of certification
: www.eurovent-certification.com

UU18WC

UU24WC
UU30WC

UU36WC



PQRCVCL0QW offered with UB18C / UB24C
PREMTB001 offered with UM30 / UM36

INDOOR				UB18C NHO	UB24C NHO	UM30 N14	UM36 N24
Capacity	Cooling	Min / Nom / Max	kW	1.8 / 4.7 / 5.1	2.7 / 6.8 / 7.4	3.2 / 7.5 / 7.8	3.8 / 9.5 / 10.0
	Heating	Min / Nom / Max	kW	1.7 / 5.2 / 5.7	1.9 / 7.5 / 8.2	3.6 / 8.0 / 8.8	4.0 / 10.0 / 10.5
Low Temperature Capacity	Heating -7°C	Max	kW	3.9	5.7	7.0	8.7
		Nom	kW	1.63	2.33	2.68	3.35
Power Input (Set)	Heating	Nom	kW	1.67	2.40	2.25	2.93
		Min / Max (Nom ESP)	W	80 / 100	100 / 140	160 / 240	200 / 360
Running Current	Cooling / Heating	Nom	A	7.3 / 7.4	9.4 / 9.6	12.0 / 10.0	14.9 / 13.0
Power Supply		Ø / V / Hz		1 / 220-240 / 50	1 / 220-240 / 50	1 / 220-240 / 50	1 / 220-240 / 50
EER				2.86	2.92	2.8	2.8
COP				3.11	3.13	3.6	3.4
SEER				5.11	5.38	5.6	5.6
SCOP				3.81	3.81	3.9	3.8
Pdesign (@ -10°C)			kW	3.2	5.2	5.8	6.5
Seasonal Energy Label	Cooling / Heating (A++ to E Scale)			A / A	A / A	A+ / A	A+ / A
Annual Energy Consumption	Cooling / Heating		kWh	322 / 1,176	442 / 1,911	469 / 2,082	594 / 2,388
	Liquid		mm (inch)	Ø6.35 (1/4)	Ø9.52 (3/8)	Ø9.52 (3/8)	Ø9.52 (3/8)
Piping Connection	Gas		mm (inch)	Ø12.7 (1/2)	Ø15.88 (5/8)	Ø15.88 (5/8)	Ø15.88 (5/8)
	Drain	O.D. / I.D.	mm	32 / 25	32 / 25	32 / 25	32 / 25
Air Flow Rate	High / Medium / Low		m³/min	13.5 / 12.0 / 10.5	18.0 / 16.5 / 14.5	22.0 / 20.0 / 18.0	32.0 / 28.0 / 24.0
Sound Pressure	Cooling	High / Medium / Low	dB(A)	36 / 34 / 32	38 / 36 / 34	37 / 35 / 34	36 / 34 / 33
Sound Power	Cooling	Max	dB(A)	59	63	62	60
Dehumidification Rate			l/h	1.1 (2.5)	2.12 (4.9)	2.8	3.2
Dimensions	Body	W x H x D	mm	882 x 260 x 450	882 x 260 x 450	900 x 270 x 700	1,250 x 270 x 700
Net Weight	Body		kg	25.3	26.1	25.3	36.0
External Static Pressure		Min - Max	mmAq (Pa)	2.5-8 (25-78)	2.5-8 (25-78)	2.5-15(25-147)	4-15(39-147)

OUTDOOR				UU18WC ULO	UU24WC UE0	UU30WC UE0	UU36WC U40
Compressor	Type			Twin Rotary	Twin Rotary	Twin Rotary	Twin Rotary
Airflow Rate	Nom		m³/min	28	50	50	58
Sound Pressure	Cooling	Nom	dB(A)	47	48	51	54
	Heating	Nom	dB(A)	49	50	52	56
Sound Power	Cooling	Max	dB(A)	65	68	70	70
Dimensions	W x H x D		mm	770 x 545 x 288	870 x 655 x 320	870 x 655 x 320	950 x 834 x 330
Net Weight			kg	37.5	44.5	45.4	58.2
Refrigerant	Type			R410A	R410A	R410A	R410A
	Charge		g	1,300	1,400	1,600	2,200
	Additional Charge		g/m	20	40	40	40
	GWP			2087.5	2087.5	2087.5	2087.5
Operation Range (Outdoor)	Cooling	Min - Max	°C DB	-10 - 46	-10 - 46	-10 - 48	-10 - 48
	Heating	Min - Max	°C WB	-10 - 18	-15 - 18	-10 - 18	-10 - 18
Power Supply			Ø / V / Hz	1 / 220-240 / 50	0 / 220-240 / 50	1 / 220-240 / 50	1 / 220-240 / 50
Power Supply Cable			No. x mm²	3C x 2.5	3C x 2.5	3C x 2.5	3C x 2.5
Transmission Cable			No. x mm²	4C x 0.75	4C x 0.75	4C x 0.75	4C x 0.75
Circuit Breaker			A	15	20	20	25
Piping Length Total		Min - Max	m	5-30	5-30	5-35	5-40
Piping Elevation Difference	IDU - ODU	Max	m	30	30	30	30
	Liquid		mm (inch)	Ø6.35 (1/4)	Ø9.52 (3/8)	Ø9.52 (3/8)	Ø9.52 (3/8)
Piping Connection	Gas		mm (inch)	Ø12.7 (1/2)	Ø15.88 (5/8)	Ø15.88 (5/8)	Ø15.88 (5/8)

- Note : 1. Due to our policy of innovation some specifications may be changed without notification.
 2. Definition of Power Input Nominal conditions - Performance tested under EN14511
 3. Capacities are based on the following conditions:
 Cooling : - Indoor Temperature 27°C DB / 19°C WB - Outdoor Temperature 35°C DB / 24°C WB Heating : - Indoor Temperature 20°C DB / 15°C WB - Outdoor Temperature 7°C DB / 6°C WB
 4. Annual energy consumption : based on average use of 350 running hours in cooling and 1,400 hours in heating per year at seasonal condition
 5. This product contains fluorinated greenhouse gases (R410A)

CEILING & FLOOR CONVERTIBLE CEILING SUSPENDED UNIT



CEILING & FLOOR CONVERTIBLE

Flexible Installation

The ceiling and floor models can be installed either on the ceiling or on the floor, thus saving on space while being installed in commercial premises.

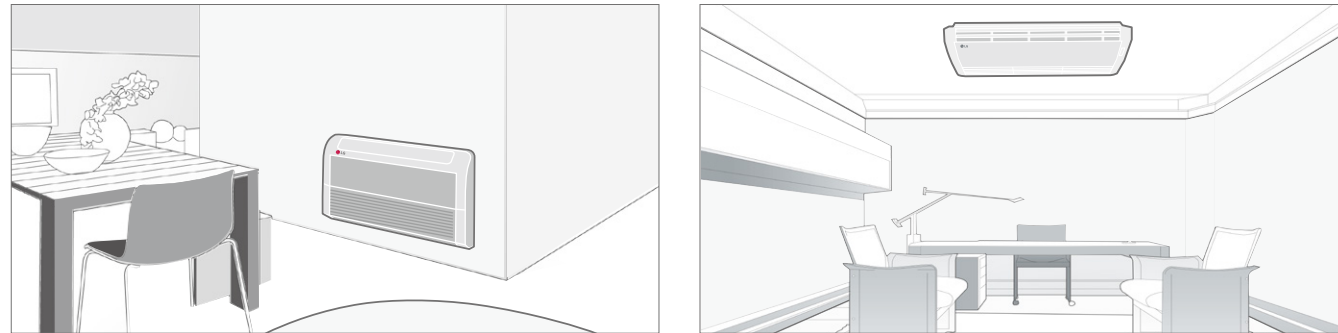

* Ceiling & Floor : CV09 NE2 / CV12 NE2

Airflow Direction Control

Vertical airflow direction can be adjusted using the remote controller, while horizontal airflow direction can be adjusted manually.

Horizontal

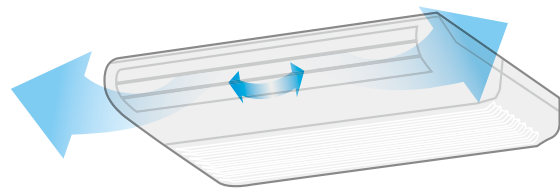

Vertical

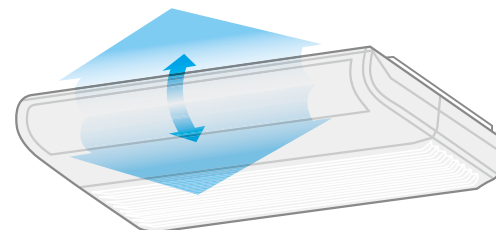

Cooling

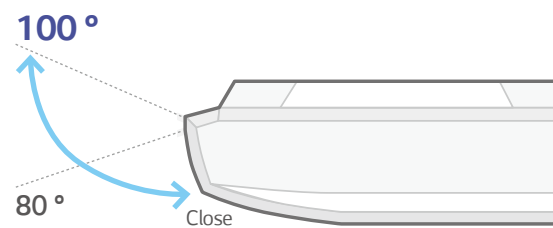

Heating

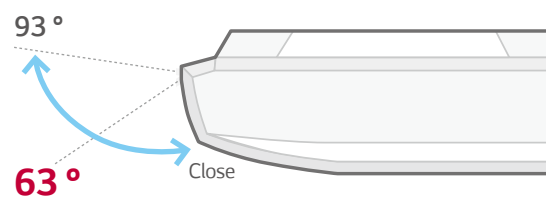

CEILING SUSPENDED UNIT

Differentiated Design

With its stunning V-shaped design and black vane, LG's new ceiling-suspended air conditioner portrays elegance and sophistication appropriate for any space. This attractive aesthetics of the air conditioner qualified it for the iF Design Award.

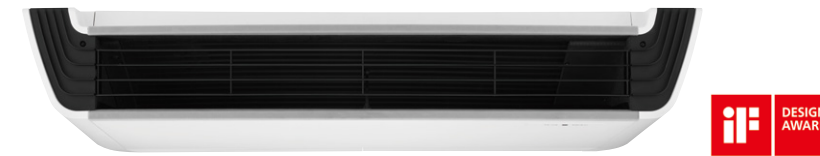

Powerful Cooling & Heating

The new LG Ceiling Suspended Unit is remarkably efficient for using in large areas due to its powerful cooling and heating operation. The powerful air speed and high volume features enhance the flow of air to reach up to 15m away from the air conditioner.



With enlarged outlet space, optimized the Air flow Path and improved Heat Exchanger's performance

Outlet Space

New LG

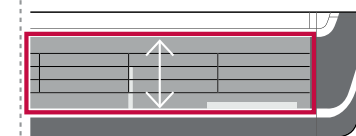

Conventional



115% ENLARGED

Optimized the Air flow Path

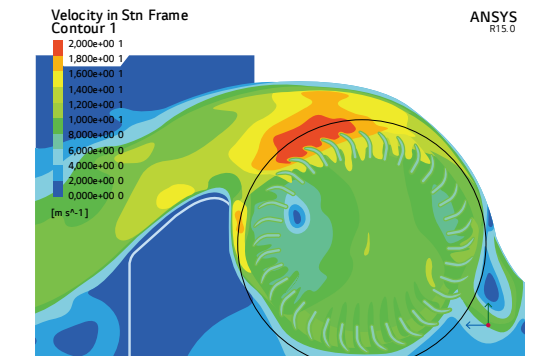

105% IMPROVED

CEILING SUSPENDED UNIT

One Touch & 2 Piece Filter

Easy IN/OUT filter structure in addition to an easy-to-use two-piece filter, which slides out for easy cleaning and maintenance.

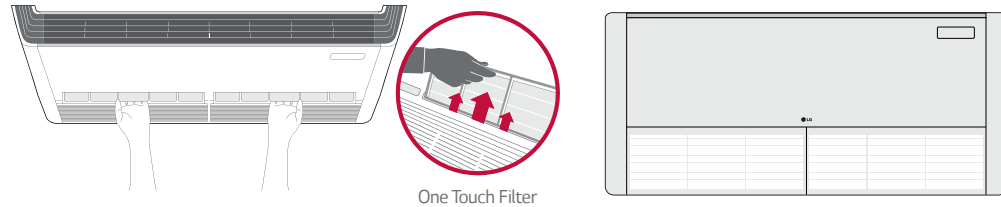

Two Thermistors Control

Users can purchase an optional control panel that includes a second thermistor that allows checking of temperature from multiple locations.

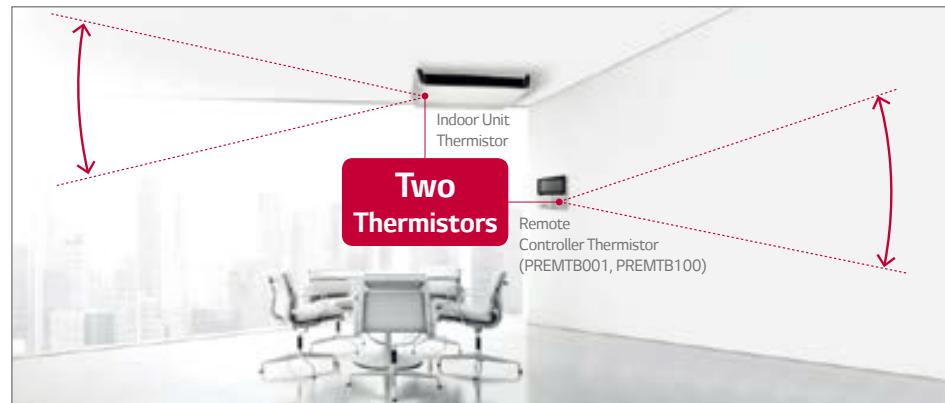

Easy installation

Installation speed and ease is improved by reducing the total number of screws used and placing the screws on the easily accessible front panel.

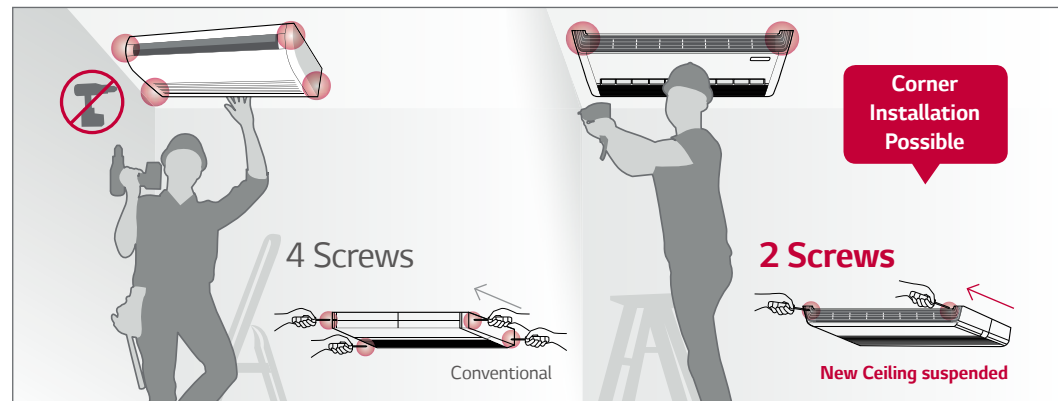

CEILING SUSPENDED UNIT



STANDARD INVERTER (R32)

UV18R / UV24R



LG participates in the ECP programme for EUROVENT AC program. Check ongoing validity of certification : www.eurovent-certification.com

UU18WR



UU24WR



INDOOR				UV18R N10	UV24R N10
Capacity	Cooling	Min / Nom / Max	kW	1.9 / 5.0 / 6.0	2.8 / 6.8 / 7.5
	Heating	Min / Nom / Max	kW	2.0 / 5.2 / 6.3	3.0 / 7.5 / 8.3
Low Temperature Capacity	Heating -7°C	Max	kW	4.6	6.9
		Nom	kW	1.38	1.97
Power Input (Set)	Heating	Nom	kW	1.52	2.20
		Min / Max	W	20 / 25	40 / 60
Power Input (Indoor)					
Running Current	Cooling/Heating	Nom	A	6.1 / 6.7	8.7 / 9.8
Power Supply			Ø / V / Hz	1 / 220-240 / 50	1 / 220-240 / 50
EER				3.62	3.45
COP				3.42	3.40
SEER				6.50	7.10
SCOP				4.30	4.30
Pdesign (@-10°C)			kW	4.1	5.4
Seasonal Energy Label	Cooling / Heating (A++ to E Scale)			A++ / A+	A++ / A+
Annual Energy Consumption	Cooling / Heating		kWh	269 / 1,335	335 / 1,758
	Liquid		mm (inch)	Ø 6.35 (1/4)	Ø 9.52 (3/8)
Piping Connection	Gas		mm (inch)	Ø 12.7 (1/2)	Ø 15.88 (5/8)
	Drain	O.D. / I.D.	mm	21.5 / 16.0	21.5 / 16.0
Air Flow Rate		High / Medium / Low	m³/min	130 / 120.0 / 11.0	160.0 / 150.0 / 14.0
Sound Pressure	Cooling	High / Medium / Low	dB(A)	42 / 40 / 39	44 / 43 / 41
		Max	dB(A)	55	61
Dehumidification Rate			l/h	1.9	3.0
Dimensions	Body	W x H x D	mm	1,200 x 235 x 690	1,200 x 235 x 690
	Body		kg	27.3	28.0

OUTDOOR				UU18WR U20	UU24WR U40
Compressor	Type			Twin Rotary	Twin Rotary
Airflow Rate	Cooling	Nom	m³/min	50	58
		Max	dB(A)	47	48
Sound Pressure	Heating	Nom	dB(A)	52	52
		Max	dB(A)	63	67
Sound Power	Cooling	Max	dB(A)	63	67
Dimensions	W x H x D		mm	870 x 650 x 330	950 x 834 x 330
Net Weight	Type		kg	44.8	56.1
				R32	R32
Refrigerant	Charge		g	1,100	1,600
	Additional Charge (after 10m)		g/m	20	35
Operation Range (Outdoor)	Cooling	GWP		675	675
		t-CO ₂ eq		0.74	1.08
Power Supply	Heating	Min ~ Max	°C DB	-15 ~ 48	-15 ~ 48
		Min ~ Max	°C WB	-18 ~ 18	-18 ~ 18
Power Supply			Ø / V / Hz	1 / 220-240 / 50	1 / 220-240 / 50
Power Supply Cable			No. x mm²	3C x 2.5	3C x 2.5
Transmission Cable			No. x mm²	4C x 0.75	4C x 0.75
Circuit Breaker			A	20	25
Piping Length Total		Min ~ Max	m	5 ~ 30	5 ~ 50
Piping Elevation Difference	IDU - ODU	Max	m	30	30
Piping Connection	Liquid		mm (inch)	Ø 6.35 (1/4)	Ø 9.52 (3/8)
	Gas		mm (inch)	Ø 12.7 (1/2)	Ø 15.88 (5/8)

Note: 1. Due to our policy of innovation some specifications may be changed without notification.

2. Definition of Power Input Nominal conditions – Performance tested under EN14511

3. Capacities are based on the following conditions:

Cooling : - Indoor Temperature 27°C DB / 19°C WB - Outdoor Temperature 35°C DB / 24°C WB Heating : - Indoor Temperature 20°C DB / 15°C WB - Outdoor Temperature 7°C DB / 6°C WB

4. Annual energy consumption : based on average use of 350 running hours in cooling and 1,400 hours in heating per year at seasonal condition

5. This product contains fluorinated greenhouse gases (R32)

CEILING SUSPENDED UNIT



STANDARD INVERTER (R32)

UV36 / UV42R / UV48R / UV60R



LG participates in the ECP programme for EUROVENT AC program.
Check ongoing validity of certification
: www.eurovent-certification.com



INDOOR				UV36R.N20	UV42R.N20	UV48R.N20	UV60R.N20
Capacity	Cooling	Min / Nom / Max	kW	4.5 / 9.5 / 13.0	5.0 / 12.0 / 14.5	5.5 / 13.4 / 16.0	5.7 / 14.4 / 15.7
	Heating	Min / Nom / Max	kW	5.0 / 10.8 / 13.7	5.5 / 13.5 / 16.5	6.1 / 15.5 / 18.0	6.8 / 16.8 / 18.7
Low Temperature Capacity	Heating -7°C	Max	kW	9.4	12.5	14.3	15.2
Power Input (Set)	Cooling	Nom	kW	2.30	3.65	4.15	4.90
	Heating	Nom	kW	2.75	4.00	4.90	5.55
Power Input (Indoor)		Min / Max	W	30 / 180	30 / 180	30 / 180	30 / 180
Running Current	Cooling/Heating	Nom	A	10.0 / 12.0	16.9 / 16.0	18.0 / 21.3	21.3 / 24.1
Power Supply		Ø / V / Hz		1 / 220-240 / 50	1 / 220-240 / 50	1 / 220-240 / 50	1 / 220-240 / 50
EER				4.13	3.28	3.23	2.94
COP				3.93	3.37	3.16	3.03
SEER				5.62	5.5	5.51	5.45
SCOP				4.04	4.0	3.96	3.92
Pdesign (@-10°C)			kW	8.05	8.05	9.3	9.3
Seasonal Energy Label	Cooling / Heating			A+ / A+ (A++ to E Scale)	A / A+	-	-
Annual Energy Consumption	Cooling / Heating		kWh	594 / 2,800	764 / 2,800	1,459 / 3,288	1,651 / 3,321
	Liquid		mm (inch)	Ø 9.52 (3/8)	Ø 9.52 (3/8)	Ø 9.52 (3/8)	Ø 9.52 (3/8)
Piping Connection	Gas		mm (inch)	Ø 15.88 (5/8)	Ø 15.88 (5/8)	Ø 15.88 (5/8)	Ø 15.88 (5/8)
	Drain	O.D. / I.D.	mm	21.5 / 16.0	21.5 / 16.0	21.5 / 16.0	21.5 / 16.0
Air Flow Rate		High / Medium / Low	m ³ /min	28.0 / 24.0 / 20.0	28.0 / 24.0 / 20.0	30.0 / 25.0 / 20.0	30.0 / 25.0 / 20.0
Sound Pressure	Cooling	High / Medium / Low	dB(A)	46 / 43 / 40	46 / 43 / 40	48 / 44 / 40	48 / 44 / 40
Sound Power	Cooling	Max	dB(A)	63	63	63	63
Dehumidification Rate			l/h	3.8	5.8	6.3	7.1
Dimensions	Body	W x H x D	mm	1,600 x 690 x 235	1,600 x 690 x 235	1,600 x 690 x 235	1,600 x 690 x 235
Net Weight	Body		kg	36.5	36.5	36.5	36.5

OUTDOOR				UU36WR.U30	UU42WR.U30	UU48WR.U30	UU60WR.U30
Compressor	Type			R-Scroll	R-Scroll	R-Scroll	R-Scroll
Airflow Rate	Nom		m ³ /min	110	110	110	110
Sound Pressure	Cooling	Nom	dB(A)	52	52	52	52
	Heating	Nom	dB(A)	54	54	54	54
Sound Power	Cooling	Max	dB(A)	66	67	68	68
Dimensions	W x H x D		mm	950 x 1,380 x 330	950 x 1,380 x 330	950 x 1,380 x 330	950 x 1,380 x 330
Net Weight			kg	87.5	87.5	87.5	87.5
Refrigerant	Type			R32	R32	R32	R32
	Charge		g	3,000	3,000	3,000	3,000
	Additional Charge (after 7.5m)		g/m	40	40	40	40
	GWP			675	675	675	675
	t-CO ₂ eq			2.03	2.03	2.03	2.03
Operation Range (Outdoor)	Cooling	Min - Max	°C DB	-15 ~ 48	-15 ~ 48	-15 ~ 48	-15 ~ 48
	Heating	Min - Max	°C WB	-25 ~ 18	-25 ~ 18	-25 ~ 18	-25 ~ 18
Power Supply			Ø / V / Hz	3 / 380-415 / 50	1 / 220-240 / 50	1 / 220-240 / 50	1 / 220-240 / 50
Power Supply Cable			No. x mm ²	5C x 2.5	3C x 6.0	3C x 6.0	3C x 6.0
Transmission Cable			No. x mm ²	4C x 0.75	4C x 0.75	4C x 0.75	4C x 0.75
Circuit Breaker			A	20	40	40	40
Piping Length Total		Min - Max	m	5-85	5-85	5-85	5-85
Piping Elevation Difference	IDU - ODU	Max	m	30	30	30	30
Piping Connection	Liquid		mm (inch)	Ø 9.52 (3/8)	Ø 9.52 (3/8)	Ø 9.52 (3/8)	Ø 9.52 (3/8)
	Gas		mm (inch)	Ø 15.88 (5/8)	Ø 15.88 (5/8)	Ø 15.88 (5/8)	Ø 15.88 (5/8)

Note : 1. Due to our policy of innovation some specifications may be changed without notification.
2. Definition of Power Input Nominal conditions - Performance tested under EN14511
3. Capacities are based on the following conditions:
Cooling : - Indoor Temperature 27°C DB / 19°C WB - Outdoor Temperature 35°C DB / 24°C WB Heating : - Indoor Temperature 20°C DB / 15°C WB - Outdoor Temperature 7°C DB / 6°C WB
4. Annual energy consumption : based on average use of 350 running hours in cooling and 1,400 hours in heating per year at seasonal condition
5. This product contains fluorinated greenhouse gases (R32)

STANDARD INVERTER (R32)

UV36 / UV42R / UV48R / UV60R



LG participates in the ECP programme for EUROVENT AC program.
Check ongoing validity of certification
: www.eurovent-certification.com



INDOOR				UV36.NK2	UV42R.N20	UV48R.N20	UV60R.N20
Capacity	Cooling	Min / Nom / Max	kW	4.5 / 9.5 / 13.0	5.0 / 12.0 / 14.5	5.5 / 13.4 / 16.0	5.7 / 14.4 / 15.7
	Heating	Min / Nom / Max	kW	5.0 / 10.8 / 13.7	5.5 / 13.5 / 16.5	6.1 / 15.5 / 18.0	6.8 / 16.8 / 18.7
Low Temperature Capacity	Heating -7°C	Max	kW	9.4	12.5	14.3	15.2
Power Input (Set)	Cooling	Nom	kW	2.30	3.65	4.15	4.90
	Heating	Nom	kW	2.75	4.00	4.90	5.55
Power Input (Indoor)		Min / Max	W	30 / 180	30 / 180	30 / 180	30 / 180
Running Current	Cooling/Heating	Nom	A	3.3 / 4.0	5.6 / 5.3	6.0 / 7.1	7.1 / 8.0
Power Supply		Ø / V / Hz		1 / 220-240 / 50	1 / 220-240 / 50	1 / 220-240 / 50	1 / 220-240 / 50
EER				4.13	3.21	3.11	2.94
COP				3.93	3.37	3.41	3.03
SEER				5.60	5.5	-	5.45
SCOP				4.00	4.0	-	3.92
Pdesign (@-10°C)			kW	8.05	8.05	-	9.3
Seasonal Energy Label	Cooling / Heating			A+ / A+ (A++ to E Scale)	A / A+	-	-
Annual Energy Consumption	Cooling / Heating		kWh	594 / 2,800	764 / 2,800	1,459 / 3,288	1,651 / 3,321
	Liquid		mm (inch)	Ø 9.52 (3/8)	Ø 9.52 (3/8)	Ø 9.52 (3/8)	Ø 9.52 (3/8)
Piping Connection	Gas		mm (inch)	Ø 15.88 (5/8)	Ø 15.88 (5/8)	Ø 15.88 (5/8)	Ø 15.88 (5/8)
	Drain	O.D. / I.D.	mm	21.5 / 16.0	21.5 / 16.0	21.5 / 16.0	21.5 / 16.0
Air Flow Rate		High / Medium / Low	m ³ /min	28.0 / 24.0 / 20.0	28.0 / 24.0 / 20.0	30.0 / 25.0 / 20.0	30.0 / 25.0 / 20.0
Sound Pressure	Cooling	High / Medium / Low	dB(A)	46 / 43 / 40	46 / 43 / 40	48 / 44 / 40	48 / 44 / 40
Sound Power	Cooling	Max	dB(A)	63	63	63	63
Dehumidification Rate			l/h	3.8	5.8	6.3	7.1
Dimensions	Body	W x H x D	mm	1,600 x 690 x 235	1,600 x 690 x 235	1,600 x 690 x 235	1,600 x 690 x 235
Net Weight	Body		kg	36.5	36.5	36.5	36.5

OUTDOOR				UU37WR.U30	UU43WR.U30	UU49WR.U30	UU61WR.U30
Compressor	Type			R-Scroll	R-Scroll	R-Scroll	R-Scroll
Airflow Rate	Nom		m ³ /min	110	110	110	110
Sound Pressure	Cooling	Nom	dB(A)	52	52	52	52
	Heating	Nom	dB(A)	54	54	54	54
Sound Power	Cooling	Max	dB(A)	66	67	68	68
Dimensions	W x H x D		mm	950 x 1,380 x 330	950 x 1,380 x 330	950 x 1,380 x 330	950 x 1,380 x 330
Net Weight			kg	87.5	87.5	87.5	87.5
Refrigerant	Type			R32	R32	R32	R32
	Charge		g	3,000	3,000	3,000	3,000
	Additional Charge (after 7.5m)		g/m	40	40	40	40
	GWP			675	675	675	675
	t-CO ₂ eq			2.03	2.03	2.03	2.03
Operation Range (Outdoor)	Cooling	Min - Max	°C DB	-15 ~ 48	-15 ~ 48	-15 ~ 48	-15 ~ 48
	Heating	Min - Max	°C WB	-25 ~ 18	-25 ~ 18	-25 ~ 18	-25 ~ 18
Power Supply			Ø / V / Hz	3 / 380-415 / 50	3 / 380-415 / 50	3 / 380-415 / 50	3 / 380-415 / 50
Power Supply Cable			No. x mm ²	5C x 2.5	3C x 6.0	5C x 2.5	5C x 2.5
Transmission Cable			No. x mm ²	4C x 0.75	4C x 0.75	4C x 0.75	4C x 0.75
Circuit Breaker			A	20	40	40	40
Piping Length Total		Min - Max	m	5-85	5-85	5-85	5-85
Piping Elevation Difference	IDU - ODU	Max	m	30	30	30	30
Piping Connection	Liquid		mm (inch)	Ø 9.52 (3/8)	Ø 9.52 (3/8)	Ø 9.52 (3/8)	Ø 9.52 (3/8)
	Gas		mm (inch)	Ø 15.88 (5/8)	Ø 15.88 (5/8)	Ø 15.88 (5/8)	Ø 15.88 (5/8)

Note : 1. Due to our policy of innovation some specifications may be changed without notification.
2. Definition of Power Input Nominal conditions - Performance tested under EN14511
3. Capacities are based on the following conditions:
Cooling : - Indoor Temperature 27°C DB / 19°C WB - Outdoor Temperature 35°C DB / 24°C WB Heating : - Indoor Temperature 20°C DB / 15°C WB - Outdoor Temperature 7°C DB / 6°C WB
4. Annual energy consumption : based on average use of 350 running hours in cooling and 1,400 hours in heating per year at seasonal condition
5. This product contains fluorinated greenhouse gases (R32)

SINGLE SPLIT SPECIFICATION

CEILING & FLOOR CONVERTIBLE

STANDARD INVERTER (R410A)

CV09
CV12



UU09W / UU12W



LG participates in the ECP programme for EUROVENT AC program.
Check ongoing validity of certification
: www.eurovent-certification.com

INDOOR				CV09 NE2	CV12 NE2
Capacity	Cooling	Min / Nom / Max	kW	1.0 / 2.5 / 2.8	1.3 / 3.3 / 3.6
	Heating	Min / Nom / Max	kW	1.2 / 3.0 / 3.3	1.5 / 3.8 / 4.2
Low Temperature Capacity	Heating -7°C	Max	kW	3.1	3.4
		Nom	kW	0.75	1.09
Power Input (Set)	Heating	Nom	kW	0.83	1.18
		Nom	W	30	40
Running Current	Cooling / Heating	Nom	A	3.26 / 3.61	4.74 / 5.13
Power Supply			Ø / V / Hz	1 / 220-240 / 50	1 / 220-240 / 50
EER				3.33	3.03
COP				3.61	3.22
SEER				5.11	5.31
SCOP				3.81	3.81
Pdesign (@ -10°C)			kW	3.0	3.0
Seasonal Energy Label	Cooling / Heating (A++ to E Scale)			A / A	A / A
Annual Energy Consumption	Cooling / Heating		kWh	172 / 1,102	218 / 1,102
	Liquid		mm (inch)	Ø6.35 (1/4)	Ø6.35 (1/4)
Piping Connection	Gas		mm (inch)	Ø9.52 (3/8)	Ø9.52 (3/8)
	Drain	O.D. / I.D.	mm	21.5 / 16.0	21.5 / 16.0
Air Flow Rate		High / Medium / Low	m³/min	7.6 / 6.9 / 6.2	9.2 / 7.6 / 6.6
Sound Pressure	Cooling	High / Medium / Low	dB(A)	38 / 35 / 32	40 / 36 / 31
Sound Power	Cooling	Max	dB(A)	52	56
Dehumidification Rate			l/h	1.2	1.2
Dimensions	Body	W x H x D	mm	900 x 490 x 200	900 x 490 x 200
Net Weight	Body		kg	13.7	13.7

OUTDOOR				UU09W ULD	UU12W ULD
Compressor	Type			Rotary	Rotary
Airflow Rate		Nom	m³/min	32	32
Sound Pressure	Cooling	Nom	dB(A)	47	47
	Heating	Nom	dB(A)	48	48
Sound Power	Cooling	Max	dB(A)	56	57
Dimensions	W x H x D		mm	770 x 540 x 245	770 x 540 x 245
Net Weight			kg	32.0	32.0
Refrigerant	Type			R410A	R410A
	Charge		g	1,000	1,000
	Additional Charge		g/m	20	20
	GWP			2,087.5	2,087.5
	TCO2eq			2.1	2.1
Operation Range (Outdoor)	Cooling	Min - Max	°C DB	-10 - 43	-10 - 43
	Heating	Min - Max	°C WB	-18 - 18	-18 - 18
Power Supply			Ø / V / Hz	1 / 220-240 / 50	1 / 220-240 / 50
Power Supply Cable			No. x mm²	3C x 2.5	3C x 2.5
Transmission Cable			No. x mm²	4C x 0.75	4C x 0.75
Circuit Breaker			A	15	15
Piping Length Total		Min - Max	m	5 - 15	5 - 15
Piping Elevation Difference	IDU - ODU	Max	m	10	10
Piping Connection	Liquid		mm (inch)	Ø6.35 (1/4)	Ø6.35 (1/4)
	Gas		mm (inch)	Ø9.52 (3/8)	Ø9.52 (3/8)

Note : 1. Due to our policy of innovation some specifications may be changed without notification.
 2. Definition of Power Input Nominal conditions - Performance tested under EN14511
 3. Capacities are based on the following conditions:
 Cooling : - Indoor Temperature 27°C DB / 19°C WB - Outdoor Temperature 35°C DB / 24°C WB Heating : - Indoor Temperature 20°C DB / 15°C WB - Outdoor Temperature 7°C DB / 6°C WB
 4. Annual energy consumption : based on average use of 350 running hours in cooling and 1,400 hours in heating per year at seasonal condition
 5. This product contains fluorinated greenhouse gases (R410A)

CONSOLE



CONSOLE

Optimised Air Flow for Cooling & Heating

During the cooling operation, the vane adjusts upwards to direct the air flow towards the ceiling. When heating, the vane directs the warm air downwards to balance out the room temperature especially towards the floor. It is controlled by wireless remote controller which is included indoor unit product

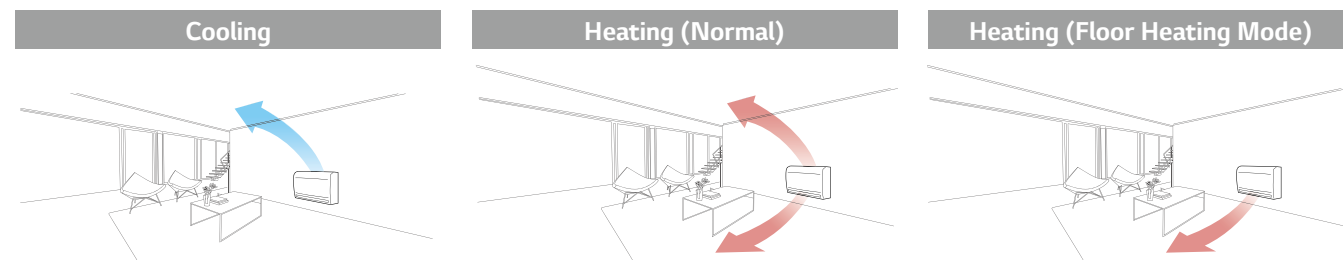

Quick Floor Heating

Console air conditioners portray high speed and powerful performance. Using the floor heating mode, console air conditioners provides floor heating at a faster pace and helps to reach the desired temperature quickly.

	Company A	Electric Heater	LG	LG Floor Heating Mode
27°C				
Vertical				
Horizontal				
15°C				
Lead Time for Heating (13°C - 21°C)	12 minutes 30 seconds	50 minutes	9 minutes 30 seconds	8 minutes 40 seconds

(Test Condition :Target Temp 23°C, Indoor Room : 13°C-, Outdoor Room : 7°C)

5-Step Vane Control

There are 5 different stages to control air flow direction.

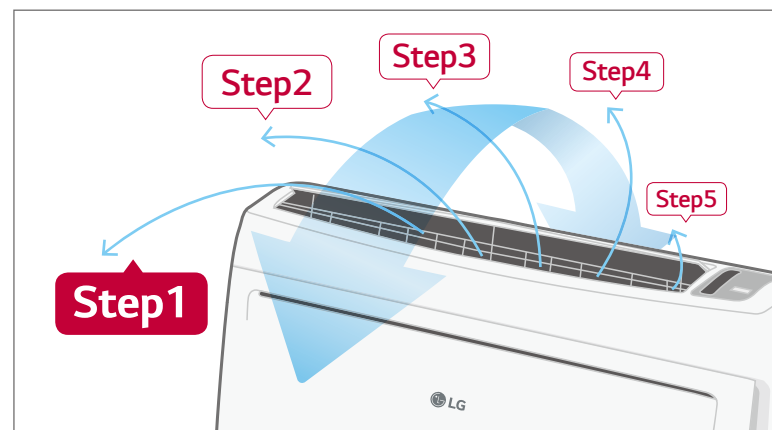

Healthier Air

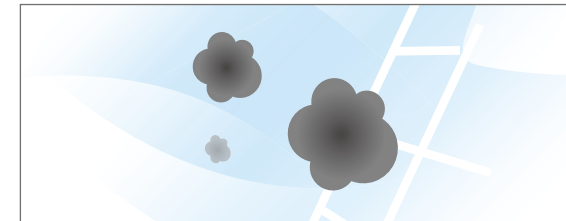

Advanced Pre Filter :

The antibacterial pre-filter primarily reduces large dust particles, mould and quilt dust.



Plasma Ion Generator :

The sterilised ion generator emits around 1.2 million ions, and traps some of the airborne hazardous substances.

Easy Installation and Service

6 Different Ways to Install Piping

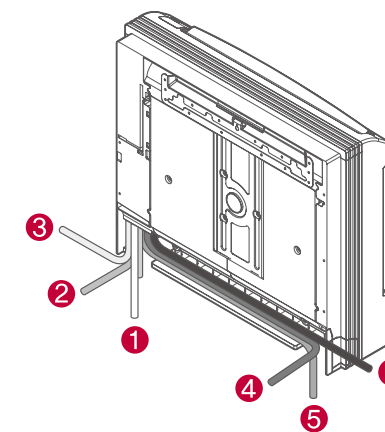

Easy Slide-type PCB

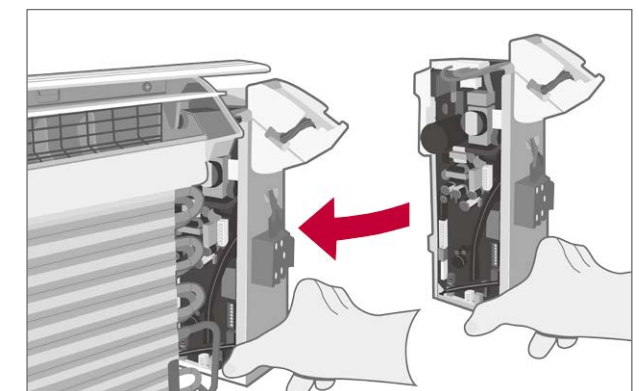

SINGLE SPLIT SPECIFICATION

CONSOLE

STANDARD INVERTER (R410A)

CQ09
CQ12
CQ18



LG participates in the ECP programme for EUROVENT AC program.
Check ongoing validity of certification
:www.eurovent-certification.com

UU09W
UU12W



UU18W



INDOOR				CQ09 NAO	CQ12 NAO	CQ18 NAO
Capacity	Cooling	Min / Nom / Max	kW	1.3 / 2.6 / 3.4	1.4 / 3.5 / 3.7	2.2 / 5.0 / 5.6
	Heating	Min / Nom / Max	kW	1.4 / 3.1 / 4.2	1.6 / 4.0 / 4.4	2.2 / 4.8 / 5.8
Low Temperature Capacity	Heating -7°C	Max	kW	3.4	3.6	4.9
		Nom	kW	0.64	1.06	1.55
Power Input (Set)	Cooling	Nom	kW	0.74	1.08	1.50
	Heating	Nom	W	20	30	40
Power Input (Indoor)		Nom	W	20	30	40
Running Current	Cooling / Heating	Nom	A	3.42 / 3.87	5.02 / 5.03	7.0 / 6.9
Power Supply			Ø / V / Hz	1 / 220-240 / 50	1 / 220-240 / 50	1 / 220-240 / 50
EER				3.98	3.30	3.23
COP				4.19	3.70	3.20
SEER				5.11	5.31	6.2
SCOP				3.81	3.81	3.81
Pdesign (@ -10°C)			kW	2.8	3.0	3.8
Seasonal Energy Label	Cooling / Heating (A++ to E Scale)			A / A	A / A	A++ / A
Annual Energy Consumption	Cooling / Heating		kWh	172 / 1,032	231 / 1,105	282 / 1,396
	Liquid		mm (inch)	Ø6.35 (1/4)	Ø6.35 (1/4)	Ø6.35 (1/4)
Piping Connection	Gas		mm (inch)	Ø9.52 (3/8)	Ø9.52 (3/8)	Ø12.7 (1/2)
	Drain	O.D. / I.D.	mm	21.5 / 16.0	21.5 / 16.0	21.5 / 16.0
	Air Flow Rate	High / Medium / Low	m³/min	8.5 / 6.7 / 5.0	9.0 / 6.9 / 5.2	10.1 / 8.6 / 7.2
Sound Pressure	Cooling	High / Medium / Low	dBA	38 / 32 / 27	39 / 32 / 27	44 / 39 / 35
Sound Power	Cooling	Max	dBA	53	56	60
Dehumidification Rate			l/h	1.2	1.4	2.3
Dimensions	Body	W x H x D	mm	700 x 600 x 210	700 x 600 x 210	700 x 600 x 210
Net Weight	Body		kg	14.0	14.0	14.0

OUTDOOR				UU09W ULD	UU12W ULD	UU18W UE4
Compressor	Type			Rotary	Rotary	Twin Rotary
Airflow Rate		Nom	m³/min	32	32	50
Sound Pressure	Cooling	Nom	dBA	47	47	47
	Heating	Nom	dBA	48	48	52
Sound Power	Cooling	Max	dBA	56	57	63
Dimensions	W x H x D		mm	770 x 540 x 245	770 x 540 x 245	870 x 655 x 320
Net Weight			kg	32.0	32.0	44.6
Refrigerant	Type			R410A	R410A	R410A
	Charge		g	1,000	1,000	1,300
	Additional Charge		g/m	20	20	20
	GWP			2,087.5	2,087.5	2,087.5
	TCO2eq			2.1	2.1	2.7
Operation Range (Outdoor)	Cooling	Min - Max	°C DB	-10 - 43	-10 - 43	-15 - 48
	Heating	Min - Max	°C WB	-18 - 18	-18 - 18	-18 - 18
Power Supply			Ø / V / Hz	1 / 220-240 / 50	1 / 220-240 / 50	1 / 220-240 / 50
Power Supply Cable			No. x mm²	3C x 2.5	3C x 2.5	3C x 2.5
Transmission Cable			No. x mm²	4C x 0.75	4C x 0.75	4C x 0.75
Circuit Breaker			A	15	15	20
Piping Length Total		Min - Max	m	5 - 15	5 - 15	5 - 30
Piping Elevation Difference	IDU - ODU	Max	m	10	10	30
Piping Connection	Liquid		mm (inch)	Ø6.35 (1/4)	Ø6.35 (1/4)	Ø6.35 (1/4)
	Gas		mm (inch)	Ø9.52 (3/8)	Ø9.52 (3/8)	Ø12.7 (1/2)

Note : 1. Due to our policy of innovation some specifications may be changed without notification.

2. Definition of Power Input Nominal conditions - Performance tested under EN14511

3. Capacities are based on the following conditions:

Cooling : - Indoor Temperature 27°C DB / 19°C WB - Outdoor Temperature 35°C DB / 24°C WB Heating : - Indoor Temperature 20°C DB / 15°C WB - Outdoor Temperature 7°C DB / 6°C WB

4. Annual energy consumption : based on average use of 350 running hours in cooling and 1,400 hours in heating per year at seasonal condition

5. This product contains fluorinated greenhouse gases (R410A)

FLOOR STANDING UNIT

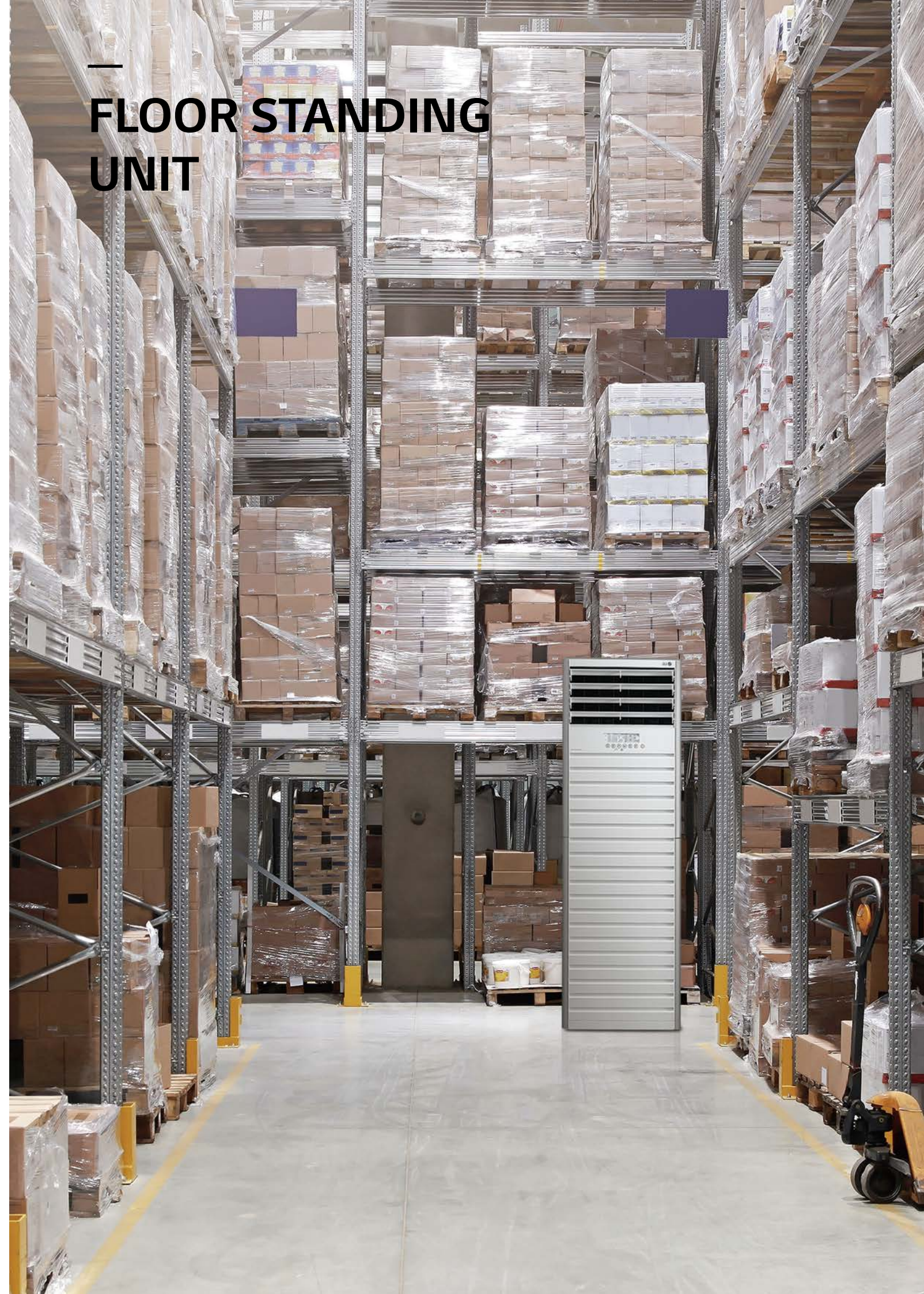

FLOOR STANDING UNIT

Stylish Design

The new LG floor standing air conditioner which is Red Dot design award winner 2013, is ideal for modern interiors in your home or office.



reddot design award
winner 2013

Quick Response

Offering powerful cooling, the commercial air conditioning system can reach a set temperature in a shorter period of time. Meanwhile, the Power Heating function provides the optimal airflow angle, guaranteeing a faster heating performance.

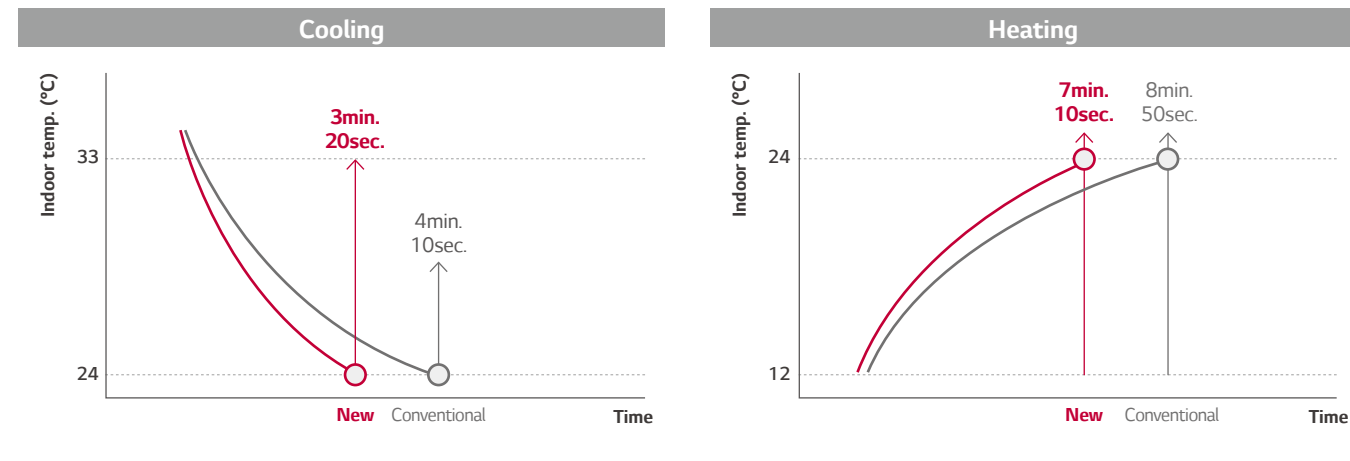

Powerful Air Flow

The new LG floor standing air conditioner is efficient for using in large areas due to its powerful cooling and heating operation. The powerful air speed and volume means the air flow can reach up to 20m away from the air conditioner.

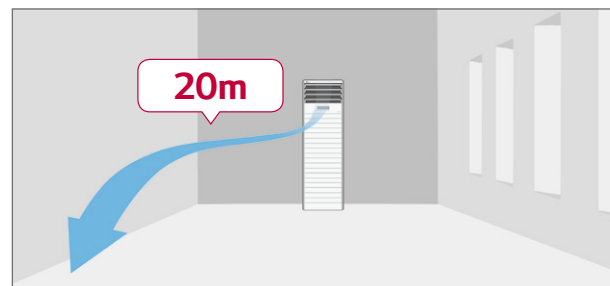

FLOOR STANDING UNIT

STANDARD INVERTER (R410A)

UP48



LG participates in the ECP programme for EUROVENT AC program. Check ongoing validity of certification : www.eurovent-certification.com

UU48W / UU49W



INDOOR				UP48 NT2	
Capacity	Cooling	Min / Nom / Max	kW	6.0 / 13.4 / 15.2	6.0 / 13.4 / 15.2
	Heating	Min / Nom / Max	kW	6.0 / 15.5 / 17.1	6.0 / 15.5 / 17.1
Low Temperature Capacity	Heating -7°C	Max	kW	16.0	16.0
Power Input (Set)	Cooling	Nom	kW	4.2	4.2
	Heating	Nom	kW	4.5	4.5
Power Input (Indoor)		Nom	W	200	200
Running Current	Cooling / Heating	Nom	A	18.1 / 19.5	5.76 / 6.20
Power Supply			Ø / V / Hz	1 / 220-240 / 50	1 / 220-240 / 50
EER				3.21	3.21
COP				3.41	3.41
SEER				5.05	5.05
SCOP				3.51	3.51
Pdesign (@ -10°C)			kW	11.5	11.5
Seasonal Energy Label	Cooling / Heating			-	-
Annual Energy Consumption	Cooling / Heating		kWh	-	-
Piping Connection	Liquid		mm (inch)	Ø9.52 (3/8)	Ø9.52 (3/8)
	Gas		mm (inch)	Ø15.88 (5/8)	Ø15.88 (5/8)
	Drain	O.D. / I.D.	mm	32 / 25	32 / 25
Air Flow Rate		High / Medium / Low	m³/min	31 / 27 / 23	31 / 27 / 23
Sound Pressure	Cooling	High / Medium / Low	dB(A)	52 / 49 / 45	52 / 49 / 45
Sound Power	Cooling	Max	dB(A)	59	59
Dehumidification Rate			l/h	5.0	5.0
Dimensions	Body	W x H x D	mm	590 x 1,840 x 460	590 x 1,840 x 460
Net Weight	Body		kg	50.0	50.0

OUTDOOR				UU48W U32	UU49W U32
Compressor	Type			Twin Rotary	Twin Rotary
Airflow Rate		Nom	m³/min	110	110
Sound Pressure	Cooling	Nom	dB(A)	52	52
	Heating	Nom	dB(A)	54	54
Sound Power	Cooling	Max	dB(A)	68	68
Dimensions	W x H x D		mm	950 x 1,380 x 330	950 x 1,380 x 330
Net Weight			kg	92.0	96.0
Refrigerant	Type			R410A	R410A
	Charge		g	3,400	3,400
	Additional Charge		g/m	40	40
	GWP			2087.5	2087.5
	TCO2eq			7.1	7.1
Operation Range (Outdoor)	Cooling	Min - Max	°C DB	-15 - 48	-15 - 48
	Heating	Min - Max	°C WB	-18 - 18	-18 - 18
Power Supply			Ø / V / Hz	1 / 220-240 / 50	3 / 380-415 / 50
Power Supply Cable			No. x mm²	3C x 5.0	5C x 5.0
Transmission Cable			No. x mm²	4C x 0.75	4C x 0.75
Circuit Breaker			A	40	20
Piping Length Total		Min - Max	m	75	75
Piping Elevation Difference	IDU - ODU	Max	m	30	30
Piping Connection	Liquid		mm (inch)	Ø9.52 (3/8)	Ø9.52 (3/8)
	Gas		mm (inch)	Ø15.88 (5/8)	Ø15.88 (5/8)

Note: 1. Due to our policy of innovation some specifications may be changed without notification.

2. Definition of Power Input Nominal conditions - Performance tested under EN14511

3. Capacities are based on the following conditions:

Cooling : - Indoor Temperature 27°C DB / 19°C WB - Outdoor Temperature 35°C DB / 24°C WB Heating : - Indoor Temperature 20°C DB / 15°C WB - Outdoor Temperature 7°C DB / 6°C WB

4. Annual energy consumption : based on average use of 350 running hours in cooling and 1,400 hours in heating per year at seasonal condition

5. This product contains fluorinated greenhouse gases (R410A)

WALL MOUNTED UNIT



SINGLE SPLIT KEY FEATURES

WALL MOUNTED UNIT

Wide Operation Range

Ideal and comprehensive solution for server rooms, machine rooms and kitchens.

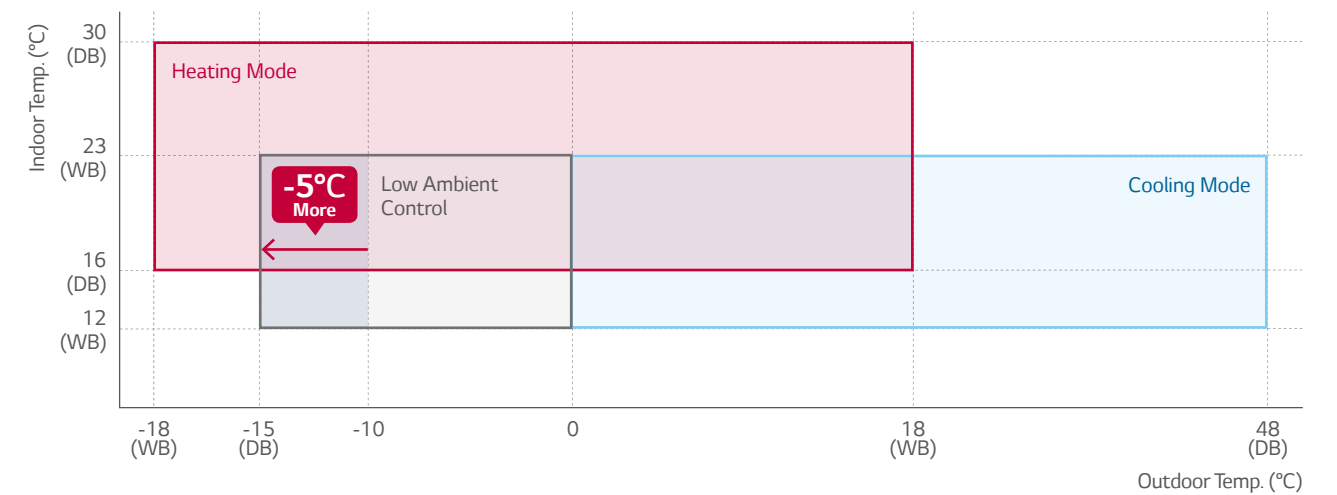

Easy Installation

Detachable Bottom Cover

The bottom cover is detachable when needed, making installation easier. Disassembly or additional support of the unit is unnecessary. Installation can be completed by one individual with LG's patented support tool.

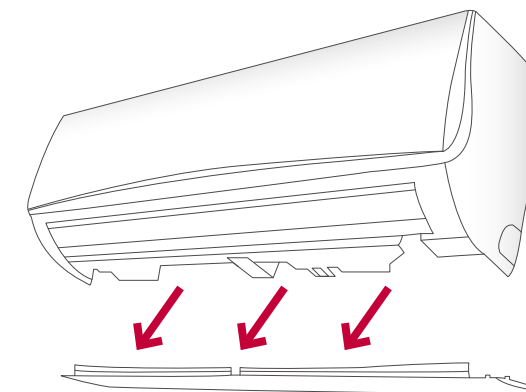

Installation Support Clip

A support clip creates adequate space between the wall and the unit for easier installation.

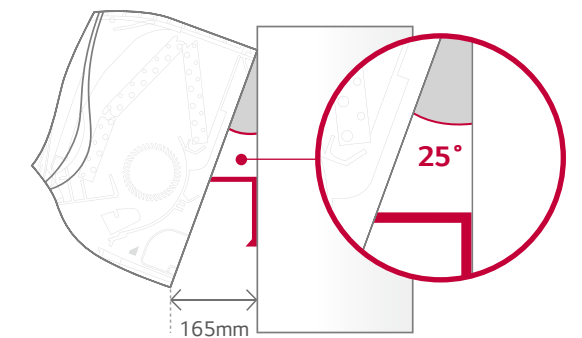

WALL MOUNTED UNIT

High Energy Efficiency

New wall mounted units provide good seasonal energy efficiency connected with Standard Inverter outdoor units.

	8.0kW	10kW
SEER	6.1 (A++)	5.4 (A)
SCOP	3.9 (A)	3.8 (A)

Powerful Cooling & Heating

20m Windblast

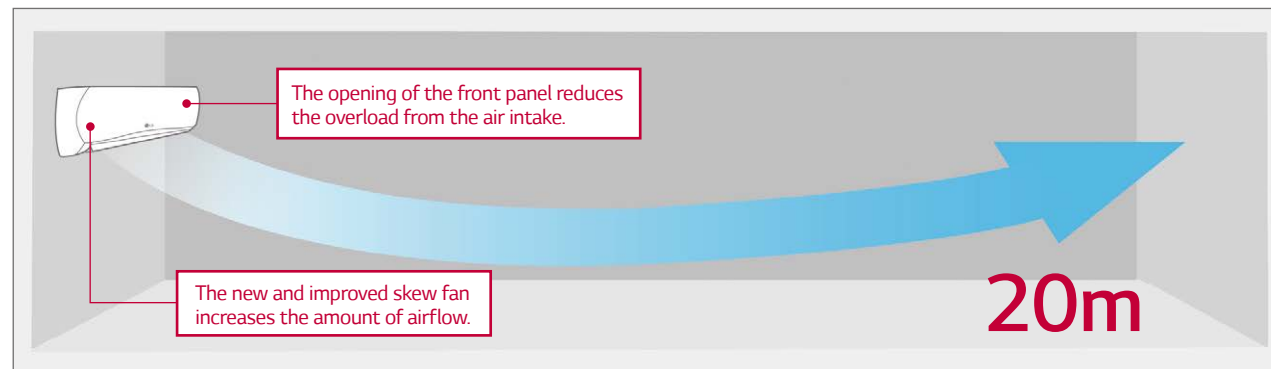

Optimised Airflow

Direction of horizontal vane can be adjusted from step 1 to step 6 with full auto swing. This function can cool and heat specific areas much faster.

Quick Cooling & Heating

Jet cooling and heating disperses air evenly at high speed to secure an optimally cooled or heated room in just 3 minutes.

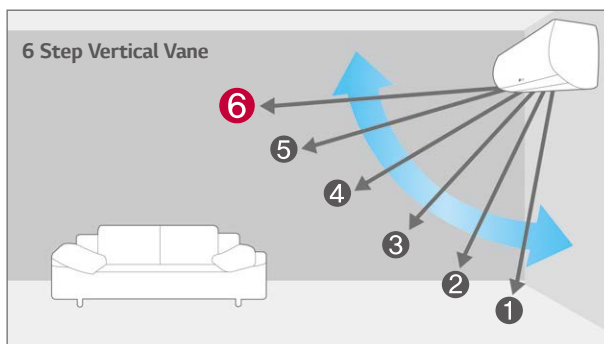

WALL MOUNTED UNIT

STANDARD INVERTER (R410A)

UJ30 / UJ36



LG participates in the ECP programme for EUROVENT AC program. Check ongoing validity of certification : www.eurovent-certification.com

UU30W



UU36W
UU37W



INDOOR				UJ30 NV2	UJ36 NV2	UJ36 NV3	
Capacity	Cooling	Min / Nom / Max	kW	3.5 / 7.8 / 8.5	4.0 / 9.5 / 10.5	4.0 / 9.5 / 10.5	
	Heating	Min / Nom / Max	kW	4.0 / 8.4 / 9.2	4.4 / 10.5 / 11.5	4.4 / 10.5 / 11.5	
Low Temperature Capacity	Heating -7°C	Max	kW	7.5	9.4	9.4	
				Power Input (Set)	Cooling	Nom	kW
Power Input (Set)	Heating	Nom	kW	2.46	3.08	3.08	
				Power Input (Indoor)	Nom		
Running Current	Cooling / Heating	Nom	A	10.0 / 10.7	12.1 / 13.4	4.0 / 4.4	
Power Supply	Ø / V / Hz			1 / 220-240 / 50	1 / 220-240 / 50	1 / 220-240 / 50	
EER				3.41	3.41	3.41	
COP				3.41	3.41	3.41	
SEER				6.11	5.41	5.41	
SCOP				3.91	3.81	3.81	
Pdesign (@ -10°C)	kW			6.3	7.6	7.6	
Seasonal Energy Label	Cooling / Heating (A++ to E Scale)			A++ / A	A / A	A / A	
Annual Energy Consumption	Cooling / Heating		kWh	448 / 2,262	615 / 2,793	615 / 2,793	
	Liquid		mm (inch)	Ø9.52 (3/8)	Ø9.52 (3/8)	Ø9.52 (3/8)	
Piping Connection	Gas		mm (inch)	Ø15.88 (5/8)	Ø15.88 (5/8)	Ø15.88 (5/8)	
	Drain	O.D. / I.D.	mm	21.5 / 16.0	21.5 / 16.0	21.5 / 16.0	
Air Flow Rate	High / Medium / Low		m³/min	22.0 / 19.0 / 16.0	27.0 / 24.0 / 20.0	27.0 / 24.0 / 20.0	
Sound Pressure	Cooling	High / Medium / Low	dB(A)	45 / 42 / 40	48 / 45 / 41	48 / 45 / 41	
Sound Power	Cooling	Max	dB(A)	61	63	63	
Dehumidification Rate	l/h			3.0	3.4	3.4	
Dimensions	Body	W x H x D	mm	1,190 x 346 x 265	1,190 x 346 x 265	1,190 x 346 x 265	
Net Weight	Body		kg	15.7	16.0	16.0	

OUTDOOR				UU30W U44	UU36W U02	UU37W U02	
Compressor	Type			Twin Rotary	Twin Rotary	Twin Rotary	
Airflow Rate	Nom		m³/min	58	90	90	
Sound Pressure	Cooling	Nom	dB(A)	48	53	53	
	Heating	Nom	dB(A)	52	54	54	
Sound Power	Cooling	Max	dB(A)	68	66	66	
Dimensions	W x H x D			950 x 834 x 330	950 x 1,170 x 330	950 x 1,170 x 330	
Net Weight	kg			58.0	81.0	85.0	
Refrigerant	Type			R410A	R410A	R410A	
	Charge			g	2,000	2,800	2,800
	Additional Charge			g/m	40	40	40
	GWP			-	2087.5	2087.5	2087.5
	TCO2eq			-	4.2	5.8	5.8
Operation Range (Outdoor)	Cooling	Min - Max	°C DB	-15 - 48	-15 - 48	-15 - 48	
	Heating	Min - Max	°C WB	-18 - 18	-18 - 18	-18 - 18	
Power Supply	Ø / V / Hz			1 / 220-240 / 50	1 / 220-240 / 50	3 / 380-415 / 50	
Power Supply Cable	No. x mm²			3C x 2.5	3C x 5.0	5C x 2.5	
Transmission Cable	No. x mm²			3C x 2.5	4C x 0.75	4C x 0.75	
Circuit Breaker	A			4C x 0.75	40	20	
Piping Length Total	Min - Max			25	5 - 50	5 - 50	
Piping Elevation Difference	IDU - ODU	Max	m	30	30	30	
Piping Connection	Liquid		mm (inch)	Ø9.52 (3/8)	Ø9.52 (3/8)	Ø9.52 (3/8)	
	Gas		mm (inch)	Ø15.88 (5/8)	Ø15.88 (5/8)	Ø15.88 (5/8)	

Note: 1. Due to our policy of innovation some specifications may be changed without notification.

2. Definition of Power Input Nominal conditions - Performance tested under EN14511

3. Capacities are based on the following conditions:

Cooling: - Indoor Temperature 27°C DB / 19°C WB - Outdoor Temperature 35°C DB / 24°C WB Heating: - Indoor Temperature 20°C DB / 15°C WB - Outdoor Temperature 7°C DB / 6°C WB

4. Annual energy consumption: based on average use of 350 running hours in cooling and 1,400 hours in heating per year at seasonal condition

5. This product contains fluorinated greenhouse gases (R410A)

SYNCHRO OPERATION



SINGLE SPLIT KEY FEATURES

SYNCHRO OPERATION

Simultaneous Operation

It is possible to connect 2, 3, or 4 indoor units to a single outdoor unit. All indoor units are operated together within the same mode from one remote controller. This allows equal air distribution in large commercial areas.

- High efficiency & Low noise
- Various indoor unit types
- Only using simple branch piping
- Standard Inverter
- 12.5 / 14.0 / 15.0 / 20.0 / 25.0kW

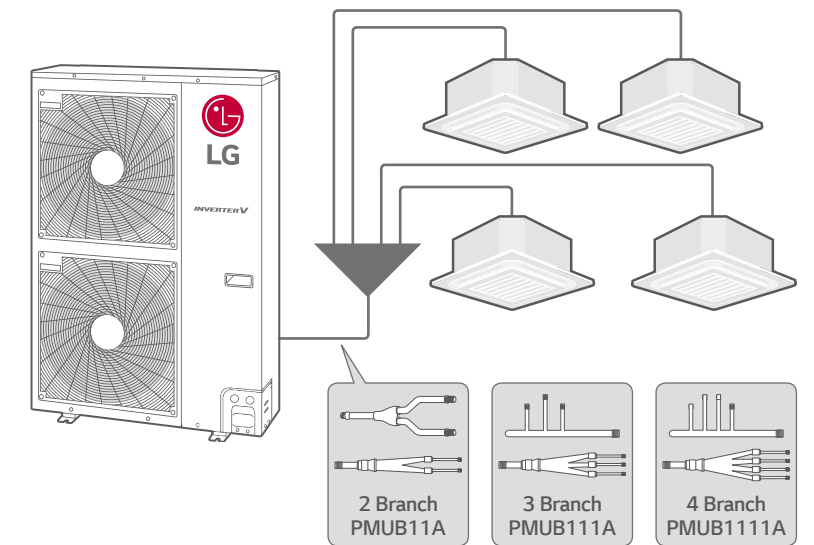

Combination Table

	Duo			Trio			Quartet				
	IDU : Indoor Unit ODU : Outdoor Unit BD : Branch Distributor Unit R / C : Wired Remote Controller										
Capacity (kW)		Cassette	Duct	Ceiling Suspended	Cassette	Duct	Ceiling Suspended	Cassette	Duct	Ceiling Suspended	
Cooling	Heating										
UU42W U32	12.5	14.0	CT24 NP4 x 2	CM24 N14 x 2 CB24L N32 x 2	CV24 NJ2 x 2	CT18 NQ4 x 3	CM18 N14 x 3 CB18L N22 x 3	CV18 NJ2 x 3	CT12 NR2 x 4	CB12L N22 x 4	-
UU43W U32				CM24 N14 x 2 CB24L N32 x 2	CV24 NJ2 x 2	CT18 NQ4 x 3	CM18 N14 x 3 CB18L N22 x 3	CV18 NJ2 x 3	CT12 NR2 x 4	CB12L N22 x 4	-
UU48W U32	14.0	16.0	CT24 NP4 x 2	CM24 N14 x 2 CB24L N32 x 2	CV24 NJ2 x 2	CT18 NQ4 x 3	CM18 N14 x 3 CB18L N22 x 3	CV18 NJ2 x 3	CT12 NR2 x 4	CB12L N22 x 4	-
UU49W U32				CM24 N14 x 2 CB24L N32 x 2	CV24 NJ2 x 2	CT18 NQ4 x 3	CM18 N14 x 3 CB18L N22 x 3	CV18 NJ2 x 3	CT12 NR2 x 4	CB12L N22 x 4	-
UU60W U32	15.0	17.0	UT30 NP4 x 2	UM30 N14 x 2	UV30 NJ2 x 2	CT18 NQ4 x 3	CM18 N14 x 3 CB18L N22 x 3	CV18 NJ2 x 3	CT12 NR2 x 4	CB12L N22 x 4	-
UU61W U32				UM30 N14 x 2	UV30 NJ2 x 2	CT18 NQ4 x 3	CM18 N14 x 3 CB18L N22 x 3	CV18 NJ2 x 3	CT12 NR2 x 4	CB12L N22 x 4	-
UU70W U34	19.0	22.4	UT36 NN2 x 2	UM36 N24 x 2	UV36 NK2 x 2	CT24 NP4 x 3	CM24 N14 x 3 CB24L N32 x 3	CV24 NJ2 x 3	CT18 NQ4 x 4	CM18 N14 x 4 CB18L N22 x 4	CV18 NJ2 x 4
UU85W U74	23.0	27.0	UT42 NM2 x 2	UM42 N24 x 2	UV42 NL2 x 2	CT24 NP4 x 3	CM24 N14 x 3 CB24L N32 x 3	CV24 NJ2 x 3	CT18 NQ4 x 4	CM18 N14 x 4 CB18L N22 x 4	CV18 NJ2 x 4
Remote Controller		Standard Wired Remote Controller : PREMTB001 (White) / PREMTB001 (Black)									
BD Unit		PMUB11A									
AC EZ		PMUB111A PQCSZ250S0									

* For Ceiling suspended, the wired remote controller has to be purchased separately.

SYNCHRO OPERATION

STANDARD INVERTER (R410A)

UU42W
UU48W
UU60W



INDOOR				CT12 / CT18 / CT24 / UT30 NR2/N*4 CM18 / CM24 / UM30 N*4 CB12L / CB18L / CB24L N*2 CV18 / CV24 / UV30 N*2
Capacity	Cooling	Min / Nom / Max	kW	* Please refer to the Combination Table
	Heating	Min / Nom / Max	kW	
Power Input	Cooling	Nom	kW	* Please refer to the specification of each indoor unit. * Below functions are not available for Synchro operation.
	Heating	Nom	kW	
Running Current	Cooling / Heating	Nom	A	- Group Control - Zone Control - Dry Contact - Auto Changeover
	Liquid		mm (inch)	
Piping Connection	Gas		mm (inch)	* Please refer to the specification of each indoor unit. * Below functions are not available for Synchro operation.
	Drain	O.D. / I.D.	mm	
	Air Flow Rate	High / Medium / Low	m ³ /min	
Sound Pressure	Cooling	High / Medium / Low	dB(A)	- Group Control - Zone Control - Dry Contact - Auto Changeover
Sound Power	Cooling	Max	dB(A)	
Dehumidification Rate			l/h	
Dimensions	Body	W x H x D	mm	
Net Weight	Body		kg	

OUTDOOR				UU42W U32	UU48W U32	UU60W U32
Compressor	Type			Twin Rotary	Twin Rotary	Twin Rotary
Airflow Rate		Nom	m ³ /min	110	110	110
Sound Pressure	Cooling	Nom	dB(A)	52	52	52
	Heating	Nom	dB(A)	54	54	54
Sound Power	Cooling	Max	dB(A)	67	68	71
Dimensions	W x H x D		mm	950 x 1,380 x 330	950 x 1,380 x 330	950 x 1,380 x 330
Net Weight			kg	92.0	92.0	92.0
Refrigerant	Type			R410A	R410A	R410A
	Charge		g	3,400	3,400	3,400
	Additional Charge		g/m	Please refer to the Product Data Book or Installation Manual		
	GWP			2087.5	2087.5	2087.5
	TCO _{2eq}			7.1	7.1	7.1
Operation Range (Outdoor)	Cooling	Min - Max	°C DB	-15 - 48	-15 - 48	-15 - 48
	Heating	Min - Max	°C WB	-18 - 18	-18 - 18	-18 - 18
Power Supply			Ø / V / Hz	1 / 220-240 / 50	1 / 220-240 / 50	1 / 220-240 / 50
Power Supply Cable			No. x mm ²	3C x 5.0	3C x 5.0	3C x 5.0
Transmission Cable			No. x mm ²	4C x 0.75	4C x 0.75	4C x 0.75
Circuit Breaker			A	40	40	40
Piping Connection	Liquid		mm (inch)	Ø9.52 (3/8)	Ø9.52 (3/8)	Ø9.52 (3/8)
	Gas		mm (inch)	Ø15.88 (5/8)	Ø15.88 (5/8)	Ø15.88 (5/8)
Max. Interunit Piping Length	Total Piping (Main + Total Branch)		m	80	80	80
	Main Piping		m	45	45	45
	Total Branch Piping		m	40	40	40
Max. Installation Height Difference	Each Branch Piping		m	15	15	15
	Indoor Unit - Outdoor Unit		m	30	30	30
	Indoor Unit - Indoor Unit		m	1	1	1

Note : 1. Due to our policy of innovation some specifications may be changed without notification.
2. Definition of Power Input Nominal conditions - Performance tested under EN14511
3. Capacities are based on the following conditions:
Cooling : - Indoor Temperature 27°C DB / 19°C WB - Outdoor Temperature 35°C DB / 24°C WB Heating : - Indoor Temperature 20°C DB / 15°C WB - Outdoor Temperature 7°C DB / 6°C WB
4. Annual energy consumption : based on average use of 350 running hours in cooling and 1,400 hours in heating per year at seasonal condition
5. This product contains fluorinated greenhouse gases (R410A)

SYNCHRO OPERATION

STANDARD INVERTER (R410A)

UU43W
UU49W
UU61W



INDOOR				CT12 / CT18 / CT24 / UT30 NR2/N*4 CM18 / CM24 / UM30 N*4 CB12L / CB18L / CB24L N*2 CV18 / CV24 / UV30 N*2
Capacity	Cooling	Min / Nom / Max	kW	* Please refer to the Combination Table
	Heating	Min / Nom / Max	kW	
Power Input	Cooling	Nom	kW	* Please refer to the specification of each indoor unit. * Below functions are not available for Synchro operation.
	Heating	Nom	kW	
Running Current	Cooling / Heating	Nom	A	- Group Control - Zone Control - Dry Contact - Auto Changeover
	Liquid		mm (inch)	
Piping Connection	Gas		mm (inch)	* Please refer to the specification of each indoor unit. * Below functions are not available for Synchro operation.
	Drain	O.D. / I.D.	mm	
	Air Flow Rate	High / Medium / Low	m ³ /min	
Sound Pressure	Cooling	High / Medium / Low	dB(A)	- Group Control - Zone Control - Dry Contact - Auto Changeover
Sound Power	Cooling	Max	dB(A)	
Dehumidification Rate			l/h	
Dimensions	Body	W x H x D	mm	
Net Weight	Body		kg	

OUTDOOR				UU43W U32	UU49W U32	UU61W U32
Compressor	Type			Twin Rotary	Twin Rotary	Twin Rotary
Airflow Rate		Nom	m ³ /min	110	110	110
Sound Pressure	Cooling	Nom	dB(A)	52	52	52
	Heating	Nom	dB(A)	54	54	54
Sound Power	Cooling	Max	dB(A)	67	68	71
Dimensions	W x H x D		mm	950 x 1,380 x 330	950 x 1,380 x 330	950 x 1,380 x 330
Net Weight			kg	96.0	96.0	96.0
Refrigerant	Type			R410A	R410A	R410A
	Charge		g	3,400	3,400	3,400
	Additional Charge		g/m	Please refer to the Product Data Book or Installation Manual		
	GWP			2087.5	2087.5	2087.5
	TCO _{2eq}			7.1	7.1	7.1
Operation Range (Outdoor)	Cooling	Min - Max	°C DB	-15 - 48	-15 - 48	-15 - 48
	Heating	Min - Max	°C WB	-18 - 18	-18 - 18	-18 - 18
Power Supply			Ø / V / Hz	3 / 380-415 / 50	3 / 380-415 / 50	3 / 380-415 / 50
Power Supply Cable			No. x mm ²	5C x 2.5	5C x 2.5	5C x 2.5
Transmission Cable			No. x mm ²	4C x 0.75	4C x 0.75	4C x 0.75
Circuit Breaker			A	20	20	20
Piping Connection	Liquid		mm (inch)	Ø9.52 (3/8)	Ø9.52 (3/8)	Ø9.52 (3/8)
	Gas		mm (inch)	Ø15.88 (5/8)	Ø15.88 (5/8)	Ø15.88 (5/8)
Max. Interunit Piping Length	Total Piping (Main + Total Branch)		m	80	80	80
	Main Piping		m	45	45	45
	Total Branch Piping		m	40	40	40
Max. Installation Height Difference	Each Branch Piping		m	15	15	15
	Indoor Unit - Outdoor Unit		m	30	30	30
	Indoor Unit - Indoor Unit		m	1	1	1

Note : 1. Due to our policy of innovation some specifications may be changed without notification.
2. Definition of Power Input Nominal conditions - Performance tested under EN14511
3. Capacities are based on the following conditions:
Cooling : - Indoor Temperature 27°C DB / 19°C WB - Outdoor Temperature 35°C DB / 24°C WB Heating : - Indoor Temperature 20°C DB / 15°C WB - Outdoor Temperature 7°C DB / 6°C WB
4. Annual energy consumption : based on average use of 350 running hours in cooling and 1,400 hours in heating per year at seasonal condition
5. This product contains fluorinated greenhouse gases (R410A)

AHU SOLUTION



SINGLE SPLIT AHU SOLUTION

AHU COMBINATION

Air Handling Applications

Economically feasible solution for pair application with air handling units.

Return / Room Air Temperature Control

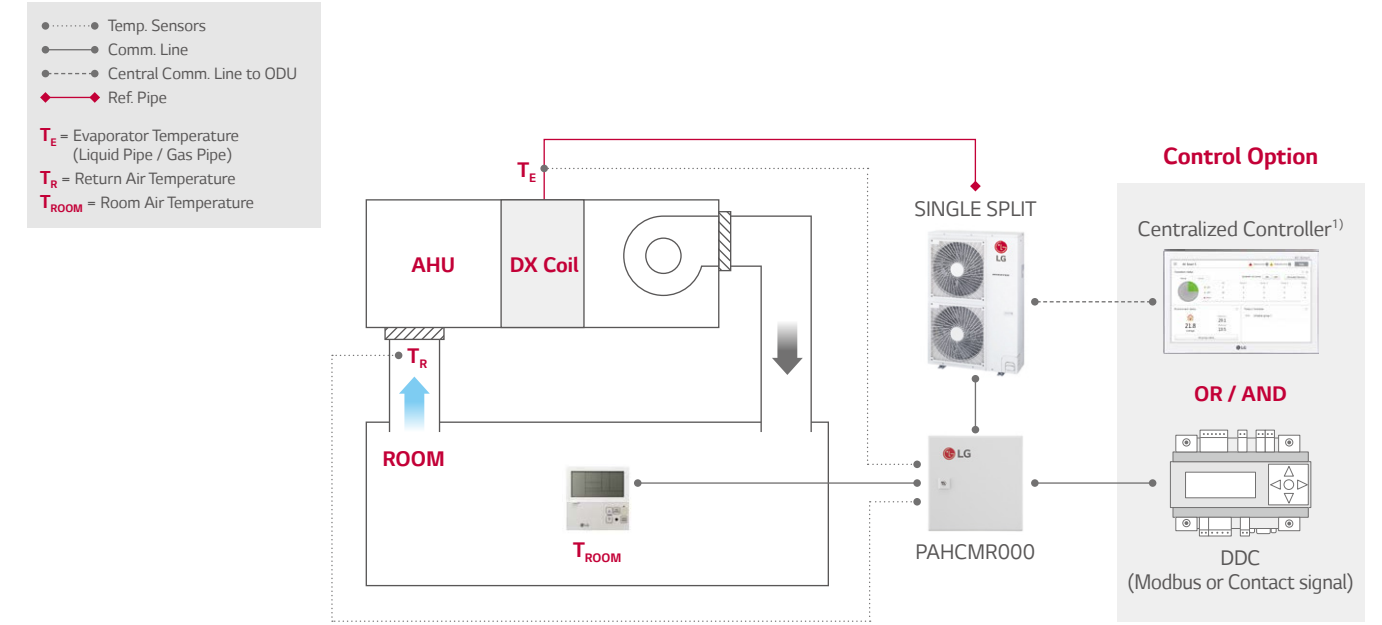

Discharge Air Temperature Control

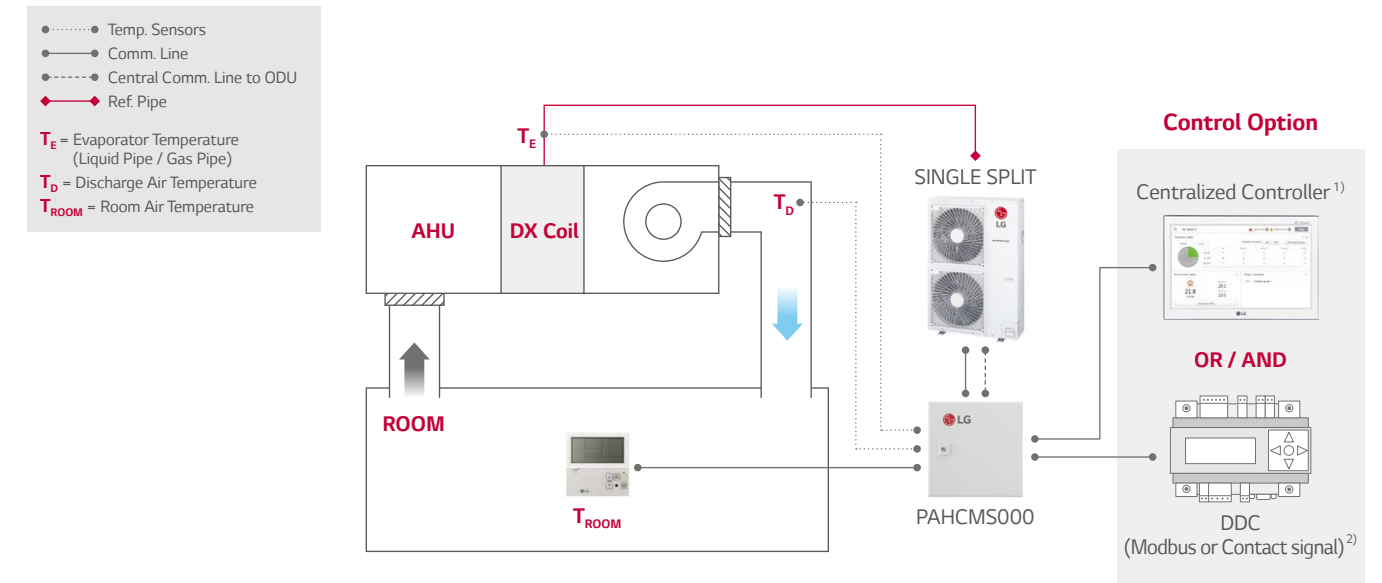

1) PI485(PMNFPT14A1) is required for using centralized controller

2) In case of applying DDC with contact signal, discharge air temperature should be measured and controlled by DDC

3) For more detail, please refer to the PDB of AHU Communication Kit

AHU COMMUNICATION KITS

COMMUNICATION KIT

NEW! PAHCMR000

NEW! PAHCMS000



Specifications

MODEL	Combination		Description	Dimensions (mm)		
	OUTDOOR UNIT	CENTRALIZED CONTROLLER		W	H	D
PAHCMR000	Single Split	•	Return / Room air temperature control by DDC or LG individual / centralized controller	300	300	155
PAHCMS000	Single Split	•	Discharge air temperature control by DDC or LG individual / centralized controller	380	300	155

Function list for Communication kit

FUNCTION LIST*	PAHCMR000	PAHCMS000	NOTE
Comm. Kit Operation	On / Off	On / Off	
Operation Mode ¹⁾	Cooling / Heating	Cooling / Heating	
Return (room) Air Temperature	16-30°C	-	
Discharge Air Temperature ²⁾	-	16-30°C	Available in case of using DDC with Modbus or LG Control system
Fan Speed ³⁾	Low / Middle / High	Low / Middle / High	It may not be possible depending on the particular condition
Forced Thermal On / Off	On / Off	-	Available in case of using DDC with contact signal
Capacity Control	-	•	Available in case of using DDC with Modbus or contact signal
Comm. Kit Operation	On / Off	On / Off	
Operation Mode ¹⁾	Cooling / Heating	Cooling / Heating	Available in case of using DDC with Modbus or LG Control system
Fan Speed	Low / Middle / High	Low / Middle / High	
Error Alarm	•	•	
Compressor On / Off	On / Off	On / Off	Available in case of using DDC with Modbus or LG individual controller PAHCMR000 doesn't provide this in case of using DDC with contact signal

1) Available operation mode can be varied depending on the setting of AHU Communication Kit.

2) This range may differ depending on the type of controller

3) To control and monitor the fan speed, DO ports for the fan speed status have to be connected with the fan unit

* Some of functions may not be possible depending on the setting of AHU Communication Kit. For more details of condition, please refer to the product data book

Combination Table

STANDARD INVERTER (1-phase)

		UU18W UE4	UU24W U44	UU30W U44	UU36W U02	UU42W U32	UU48W U32	UU60W U32
Capacity	Cooling kW	4.7	7.7	8.0	10.0	12.5	13.9	14.6
	Heating kW	5.5	8.0	9.0	11.0	14.0	15.4	16.9
AHU Kit	PAHCMR000	•	•	•	•	•	•	•
	PAHCMS000	•	•	•	•	•	•	•

STANDARD INVERTER (3-phase)

		UU37W U02	UU43W U32	UU49W U32	UU61W U32	UU70W U34	UU85W U74
Capacity	Cooling kW	10.0	12.5	13.9	14.6	19.0	23.0
	Heating kW	11.0	14.0	15.4	16.9	22.4	27.0
AHU Kit	PAHCMR000	•	•	•	•	•	•
	PAHCMS000	-	-	-	-	•	•

ACCESSORIES

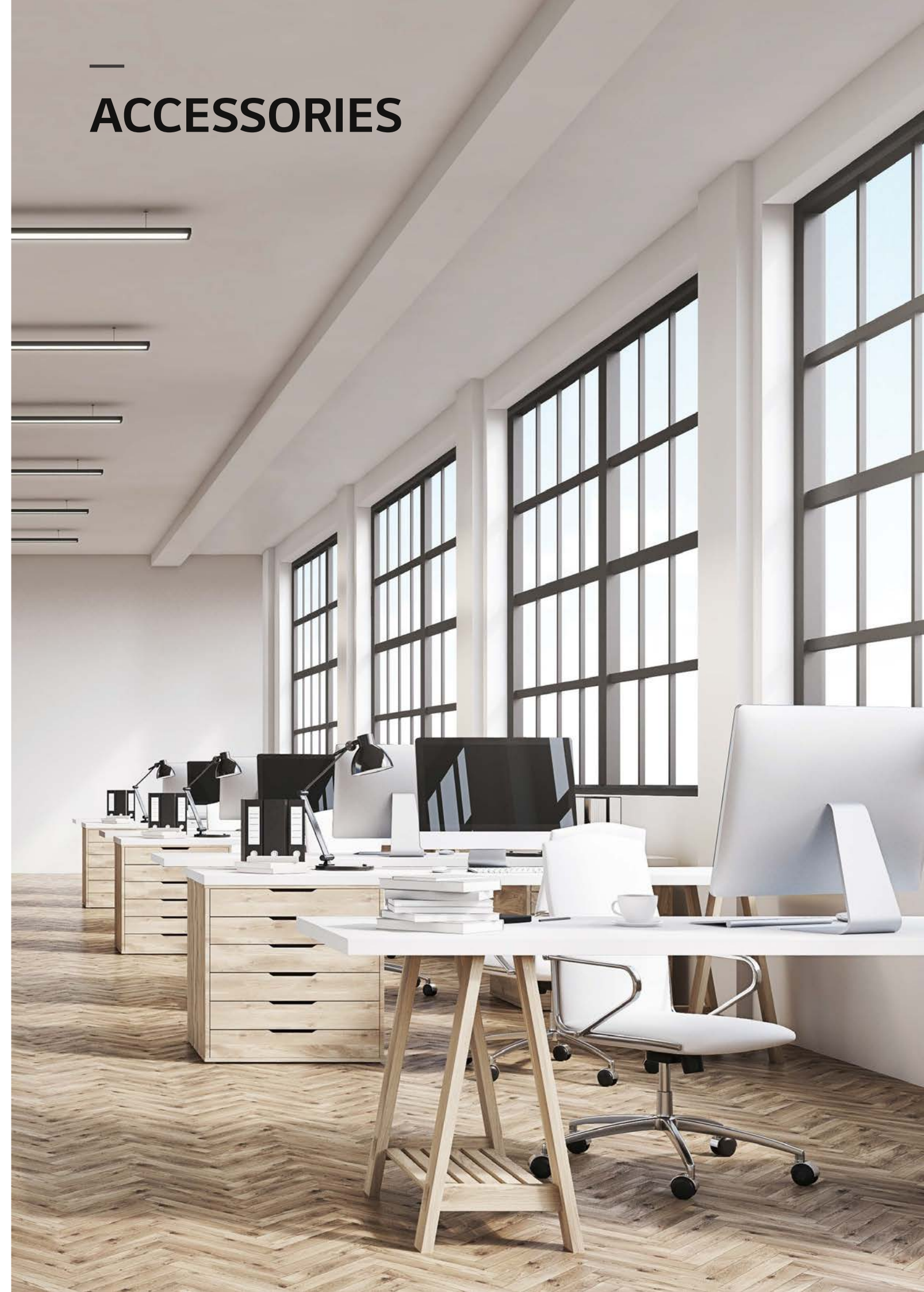

LG Wi-Fi MODEM

Control LG air conditioners via using the internet devices as Android or iOS bases smartphones

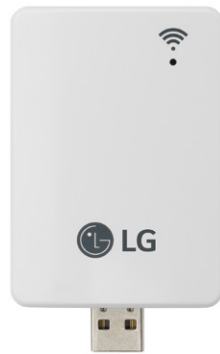

PWFMD200

Features

- Access LG air conditioner anytime and from anywhere with Wi-Fi equipped device
- LG's exclusive Home Appliances control app(SmartThinQ) is available
- Simple operation for various functions
 - On/Off
 - Operation Mode
 - Current/Set Temperature
 - Fan Speed
 - Vane Control²⁾
 - Reservation (Sleep, Weekly On/Off)
 - Energy Monitoring¹⁾
 - Filter Management
 - Error check

Model Name	PWFMD200
Size (W x H x D, mm)	48 x 68 x 14
Interfaceable Products	Multi V Indoor unit ³⁾
Connection Type	Indoor unit 1:1
Communication Frequency	2.4 GHz
Wireless Standards	IEEE 802.11b/g/n
Mobile Application	LG Smart ThinQ (Android v4.1(Jellybean) or higher, iPhone iOS 9.0 or higher)
Optional Extension Cable	PWYREW000 (10m extension)

* Functionality may be different according to each IDU model
 * User interface of application shall be revised for its design and contents improvement
 * Application is optimized for smartphone use, so it may not be well functioning with tablet devices
 1) LG Centralized controller and PDI installation is required for this function
 2) Vane Control may not be possible according to the type of Indoor unit
 3) For the compatibility with Indoor unit, please contact regional office



Overview

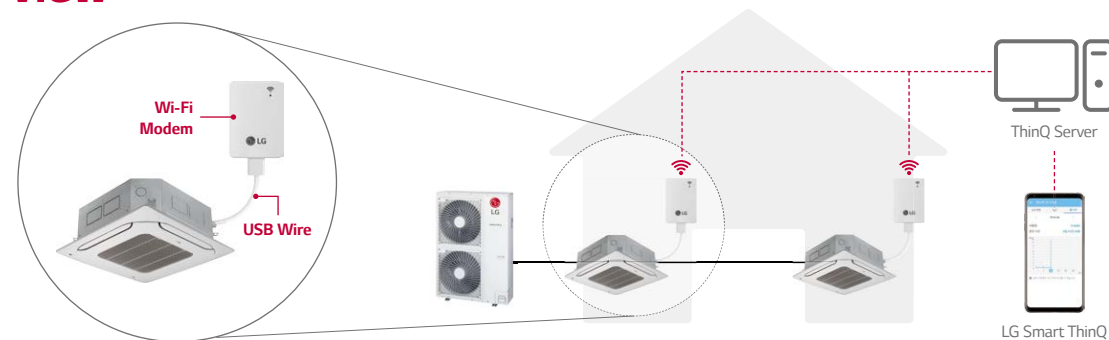

* Search "LG Smart ThinQ" on Google market or Appstore then download the app.
 * Internet service with Wi-Fi connection has to be available

Wi-Fi CONTROLLER¹⁾

LG-RC-WF-1



Features

- No need external power
- CAC system unit capacity (SCAC, Multi and Multi V)
- Control and monitor by mobile device
- Additional internet service has to be available and registration user account in IntesisHome cloud to use Wi-Fi controller is mandatory
- IntesisHome cloud application is available for smart devices such as smart phone(Android, iOS), laptop, tablet.

Model Name	LG-RC-WF-1
Start / Stop Operation	.
Operation Mode	Cool / Heat / Auto / Fan / Dry
Set Point	.
Ambient Temperature	.
Fan Speed	.

Specifications

Model Name	LG-RC-WF-1
Enclosure	ABS (UL 94 HB), 2.5 mm thickness
Dimensions (mm)	70 x 108 x 28 mm
Weight (g)	80g
Color	White
Power Supply	12V, 60mA typical Doesn't require external power supply (supplied by the Indoor Unit)
Mounting	Wall
Operating Temperature	From 0°C to 40°C
Operating Humidity	<93% HR, no condensation
Stock Humidity	<93% HR, no condensation
RoHS Conformity	Compliant with RoHS directive (2002/95/CE)
Certifications	CE conformity to EMC directive (2004/108/EC), Low-voltage directive (2006/95/EC) EN 60950-1 / EN301489-1 v1.8.1 / EN 301489-17 v2.1.1

Overview

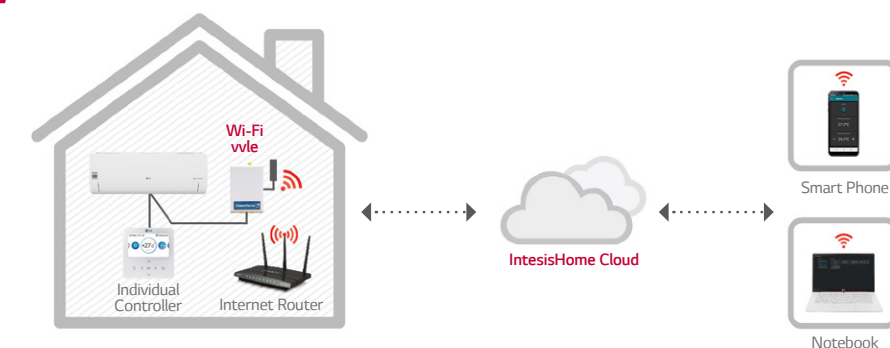

1) This product is provided by Intesis.

Wi-Fi CONTROLLER¹⁾



LG-IR-WF-1

Models Applied

- Connectable with the indoor unit having IR receiver
- Power supply includes EU-UK-US-AU heads
- On / Off status and mode indicated by LED light
- Additional internet service has to be available and registration user account in Intesis Home cloud to use Wi-fi controller is mandatory
- IntesisHome cloud app is available for android phone or iOS phone
- Control and monitor
- Easy to install : Wall or desktop mounted
- Automatic firmware Updates*

Model Name	LG-IR-WF-1
Start / Stop Operation	•
Operation Mode	Cool / Heat / Auto / Fan / Dry
Set Point	•
Ambient Temperature	•
Fan Speed	•

* Internet access is necessary

Specifications

Model Name	LG-IR-WF-1
Enclosure	ABS (V-O, 5VB) 2,1 mm thickness PC (V-2) 1mm thickness
Dimensions (mm)	81 × 78 × 28
Weight (g)	76
Color	White
Power Supply	5VDC 0,2 A NEC Class 2 or Limited Power Source (LPS) and SELV Rated Power supply
Mounting	Wall
LED Indicators	1 × Device Status
Operating Temperature	From 0°C to 40°C
Operating Humidity	<93% HR, no Condensation
Stock Humidity	<93% HR, no Condensation
RoHS Conformity	Compliant with RoHS Directive (2002 / 95 / CE) Compliant with RoHS Directive (2002 / 95 / CE)
Certifications	CE Conformity to EMC Directive (2004 / 108 / EC) and Low-voltage Directive (2006 / 95 / EC) EN 60950-1 / EN 301489-1 v1.8.1 / EN 300328

Overview

Case 1) Connection with Indoor Units with IR Receiver



Case 2) Connection with Duct Type Indoor Units

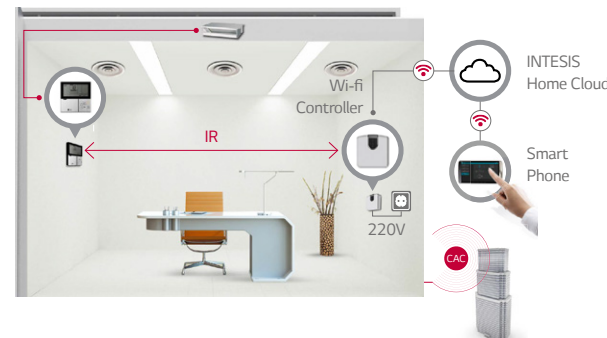

1) This product is provided by Intesis.

SYNCHRO BRANCHES



- 2 Units PMUB11A
- 3 Units PMUB111A
- 4 Units PMUB1111A

Features

- Various Y Branch pipes of different capacities make installation easier
- Y Branch and header branch for both gas and liquid are provided
- Insulation material is also provided for covering the branches

Models Applied

Standard Inverter : 12.5 / 14.0 / 15.0 / 20.0 / 25.0kw

Application

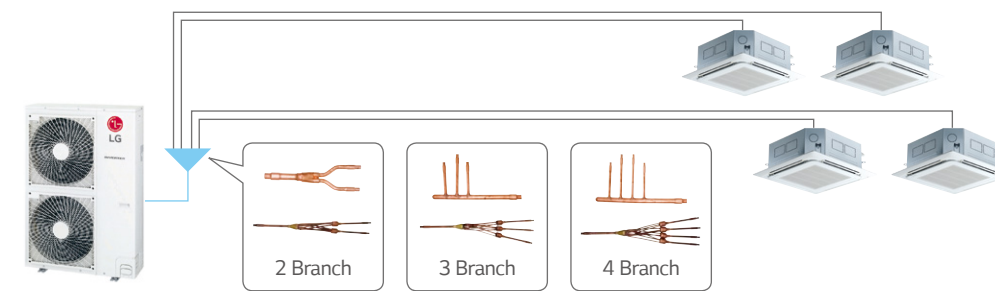

Branching kit

Indoor Classification	Model Name	Capacity Ratio(%)
2 Units	PMUB11A	50:50 (1:1)
3 Units	PMUB111A	33:33:33 (1:1:1)
4 Units	PMUB1111A	25:25:25:25 (1:1:1:1)

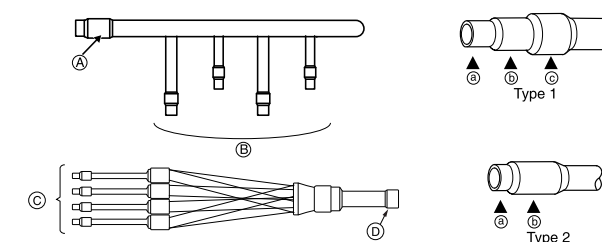

	a	b	c	Type
A	Ø15.88 (5/8)	Ø19.05 (3/4)	Ø25.4 (1)	1
B	Ø9.52 (3/8) Ø12.7 (1/2)	Ø12.7 (1/2) Ø15.88 (5/8)	-	2
C	Ø6.35 (1/4)	Ø9.52 (3/8)	-	2
D	Ø9.52 (3/8)	Ø12.7 (1/2)	-	2

CEILING CASSETTE

CT09R NR0 / CT12R NR0

(Unit : mm)

Part Name
1 Gas Pipe Connection
2 Liquid Pipe Connection
3 Drain Pipe Connection
4 Power and Communication cable routing hole
5 Wired remote controller wire routing hole
6 Air Intake
7 Air Outlet
8 Decoration Panel (PT-QCHW0)
9 Decoration Corner Cover
10 Decoration Coner Display Cover
11 Flexible Drain Hose
12 Fresh air Intake Hole

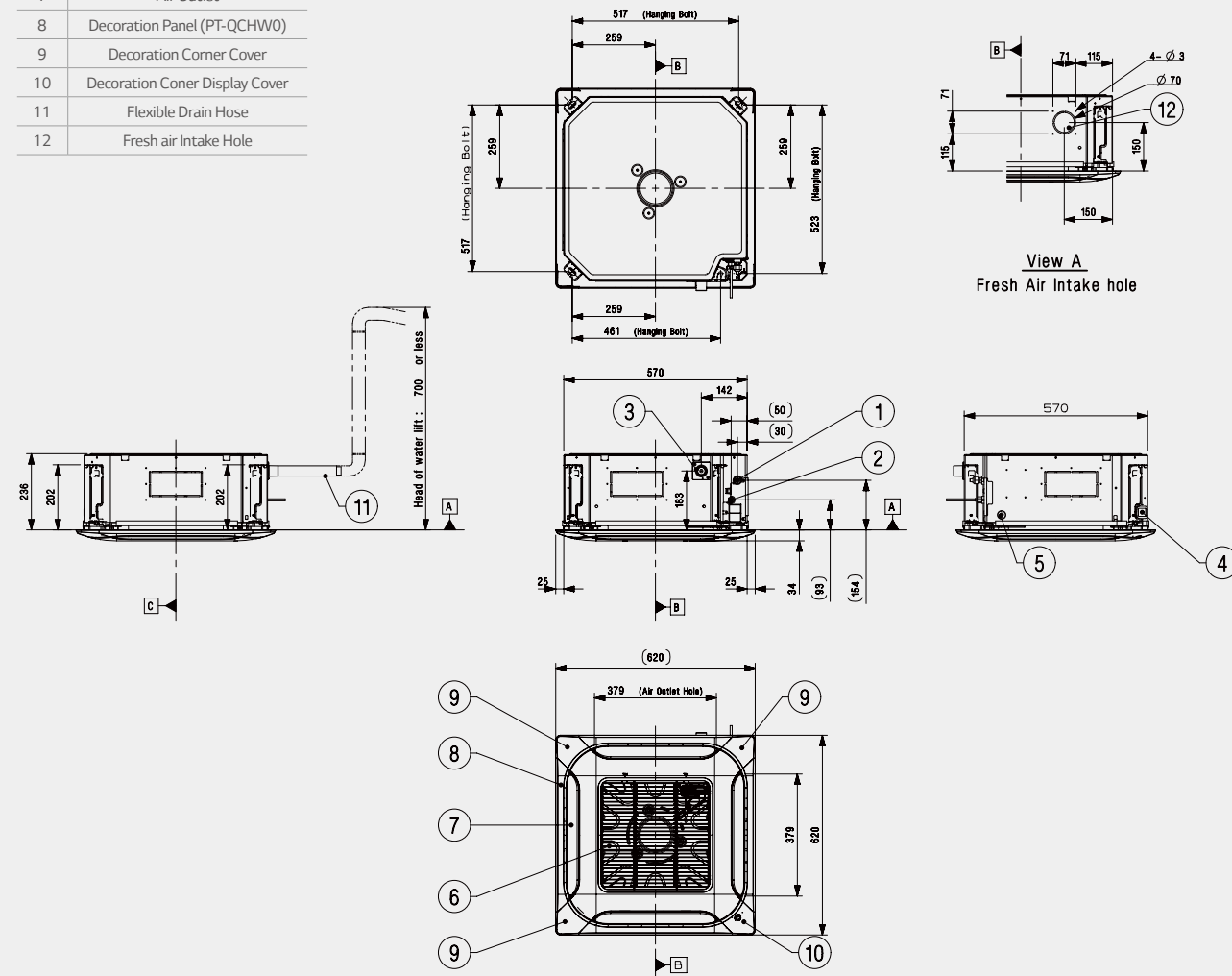

CT18R NQ0

(Unit : mm)

Part Name
1 Gas Pipe Connection
2 Liquid Pipe Connection
3 Drain Pipe Connection
4 Power and Communication cable routing hole
5 Wired remote controller wire routing hole
6 Air Intake
7 Air Outlet
8 Decoration Panel (PT-QCHW0)
9 Decoration Corner Cover
10 Decoration Coner Display Cover
11 Flexible Drain Hose
12 Fresh air Intake Hole

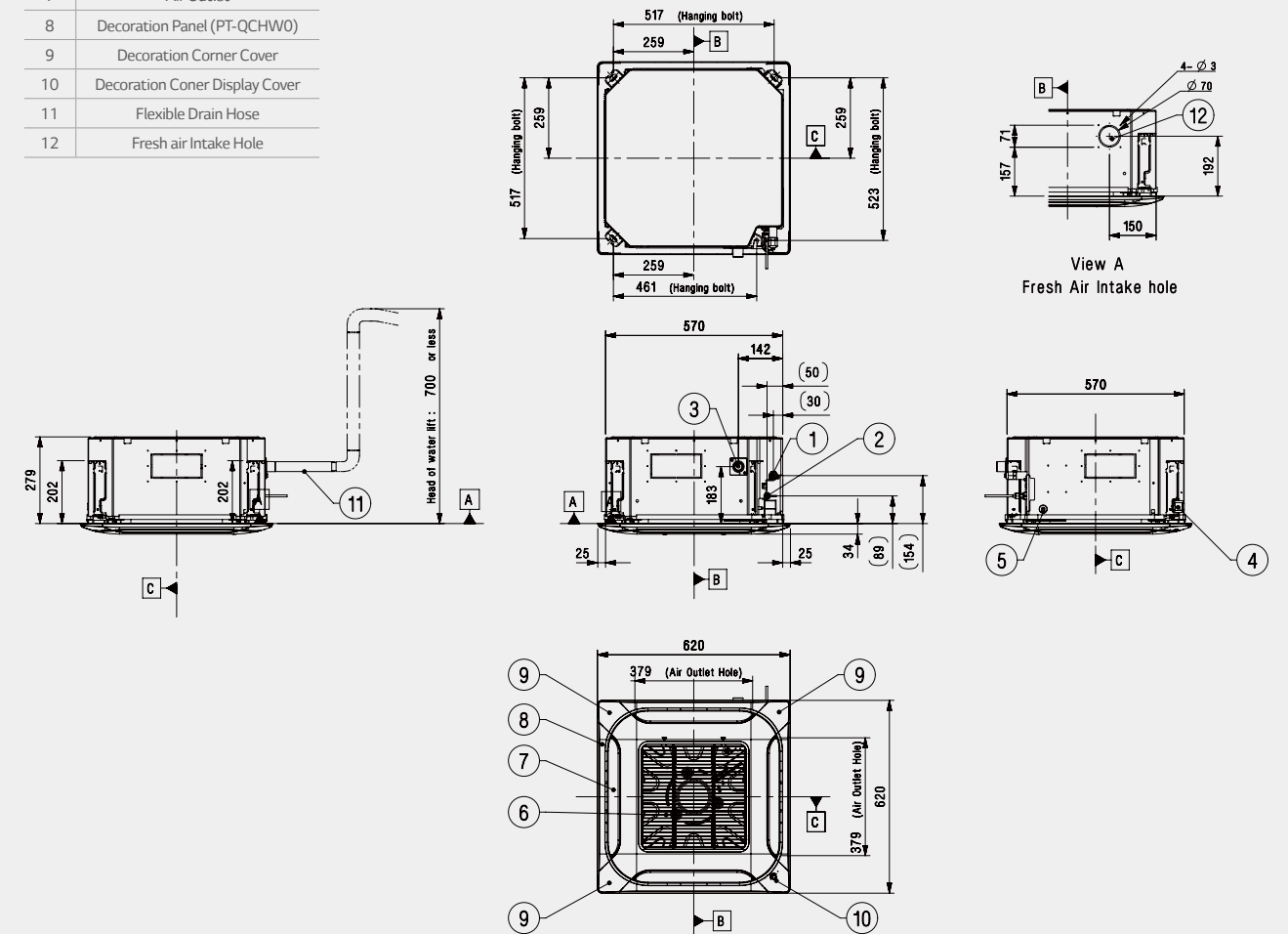

CEILING CASSETTE

CT24R NP0 / UT30R NP0

(Unit : mm)

Part Name
1 Gas Pipe Connection
2 Liquid Pipe Connection
3 Drain Pipe Connection
4 Power and Communication cable routing hole
5 Wired remote controller wire routing hole
6 Air Inlet
7 Air Outlet
8 Decoration Panel (PT-MCHWO)
9 Decoration Corner Cover
10 Flexible Drain Hose
11 Fresh air Intake Hole

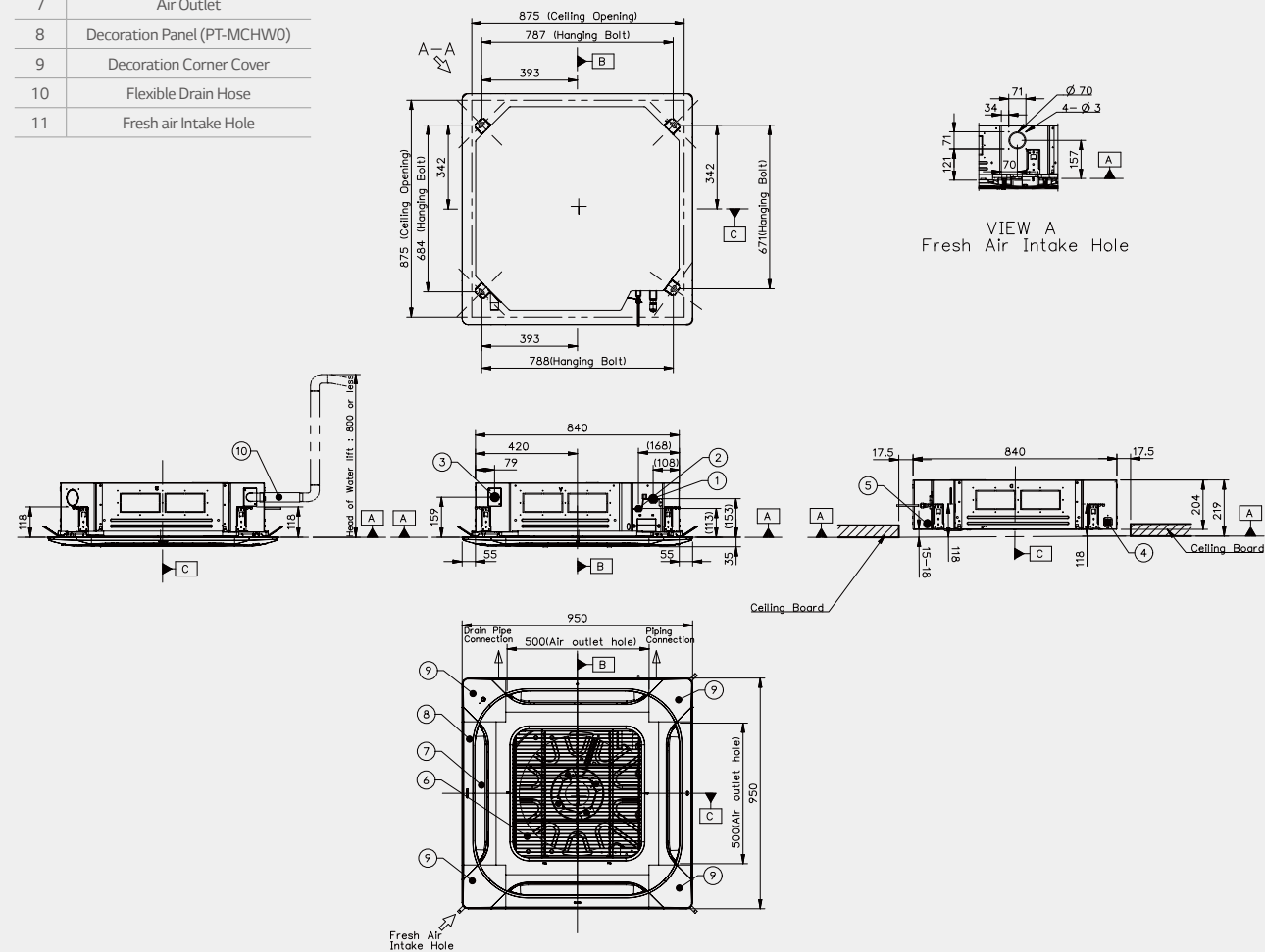

UT36R NM0 / UT42R NM0 / UT48R NM0 / UT60R NM0

(Unit : mm)

Part Name
1 Gas Pipe Connection
2 Liquid Pipe Connection
3 Drain Pipe Connection
4 Power and Communication cable routing hole
5 Wired remote controller wire routing hole
6 Air Inlet
7 Air Outlet
8 Decoration Panel (PT-MCHWO)
9 Decoration Corner Cover
10 Flexible Drain Hose
11 Fresh air Intake Hole

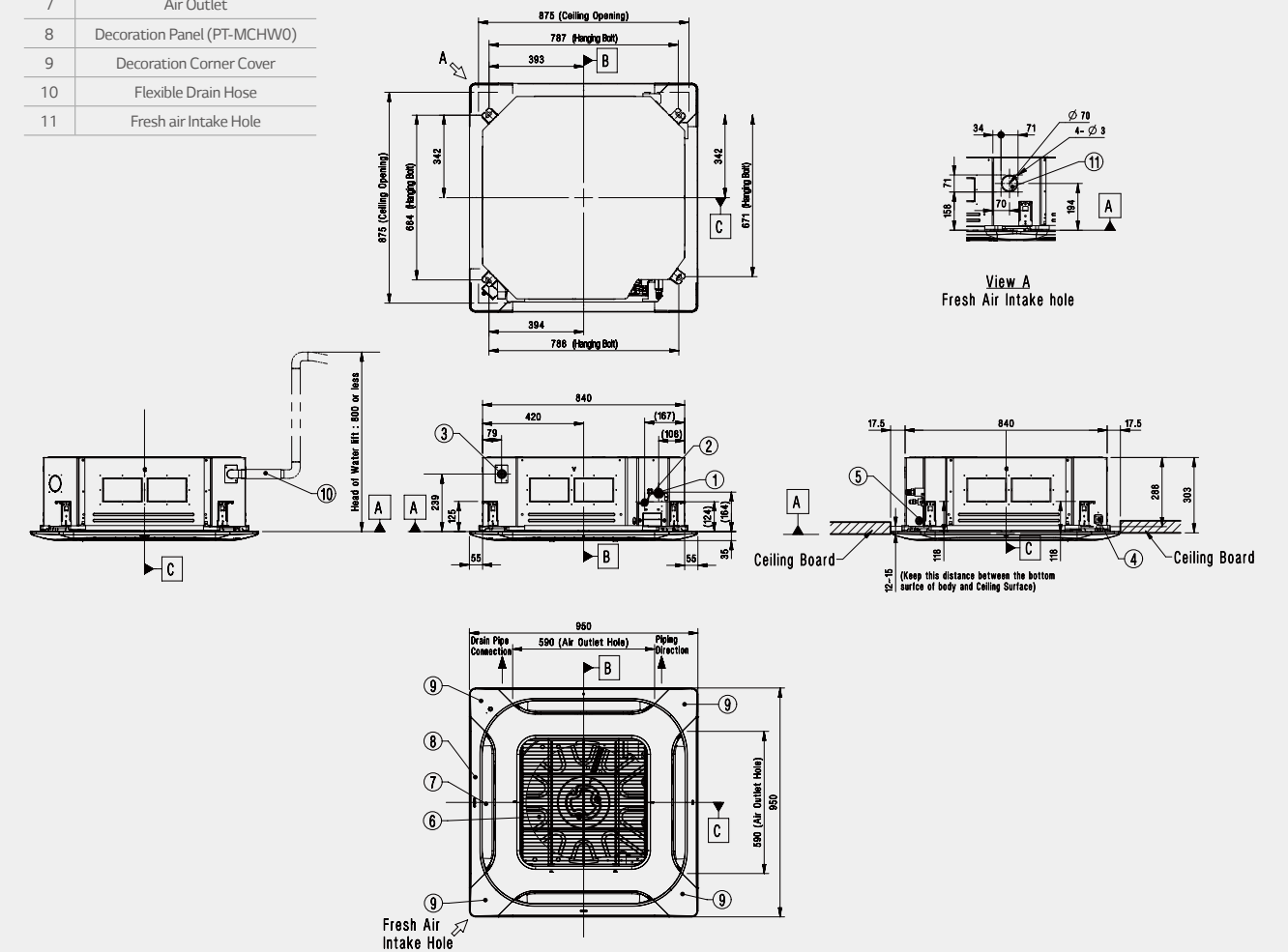

CEILING CASSETTE

CT09 NR2 / CT12 NR2

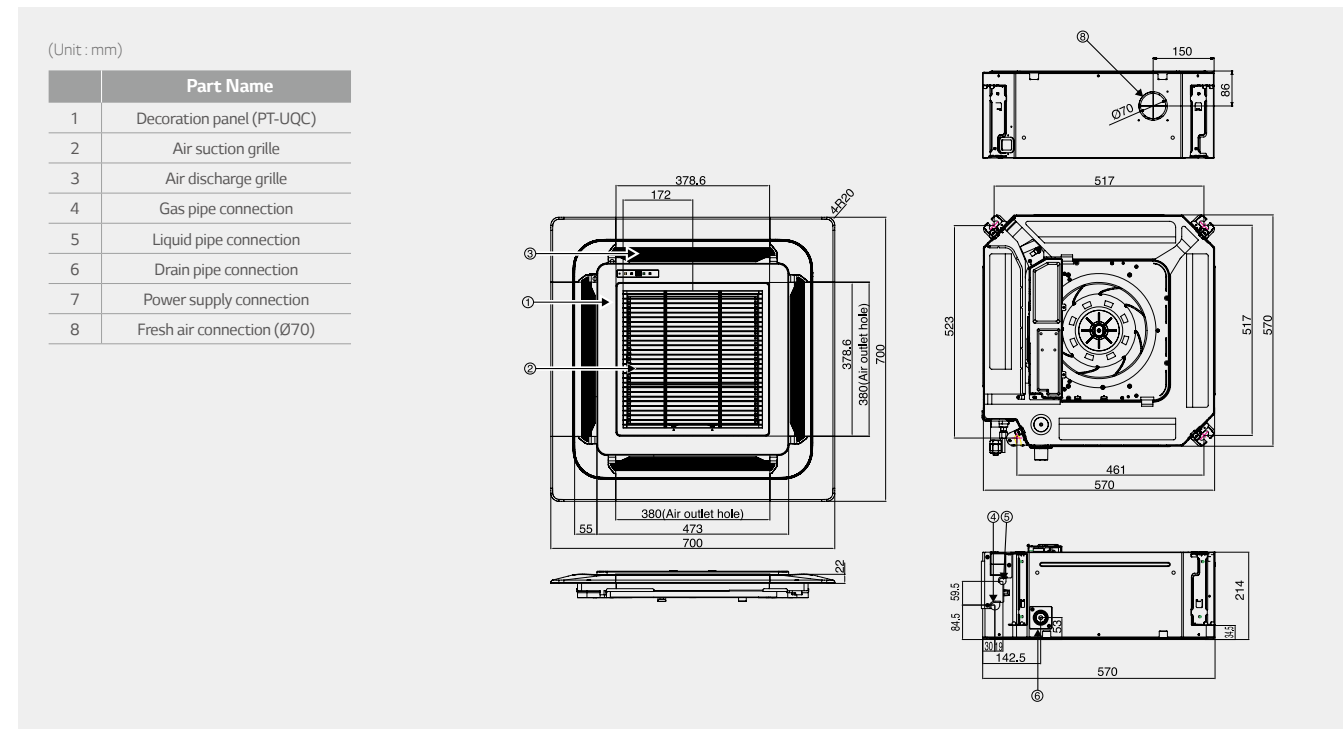

CT24 NP4 / UT30 NP4

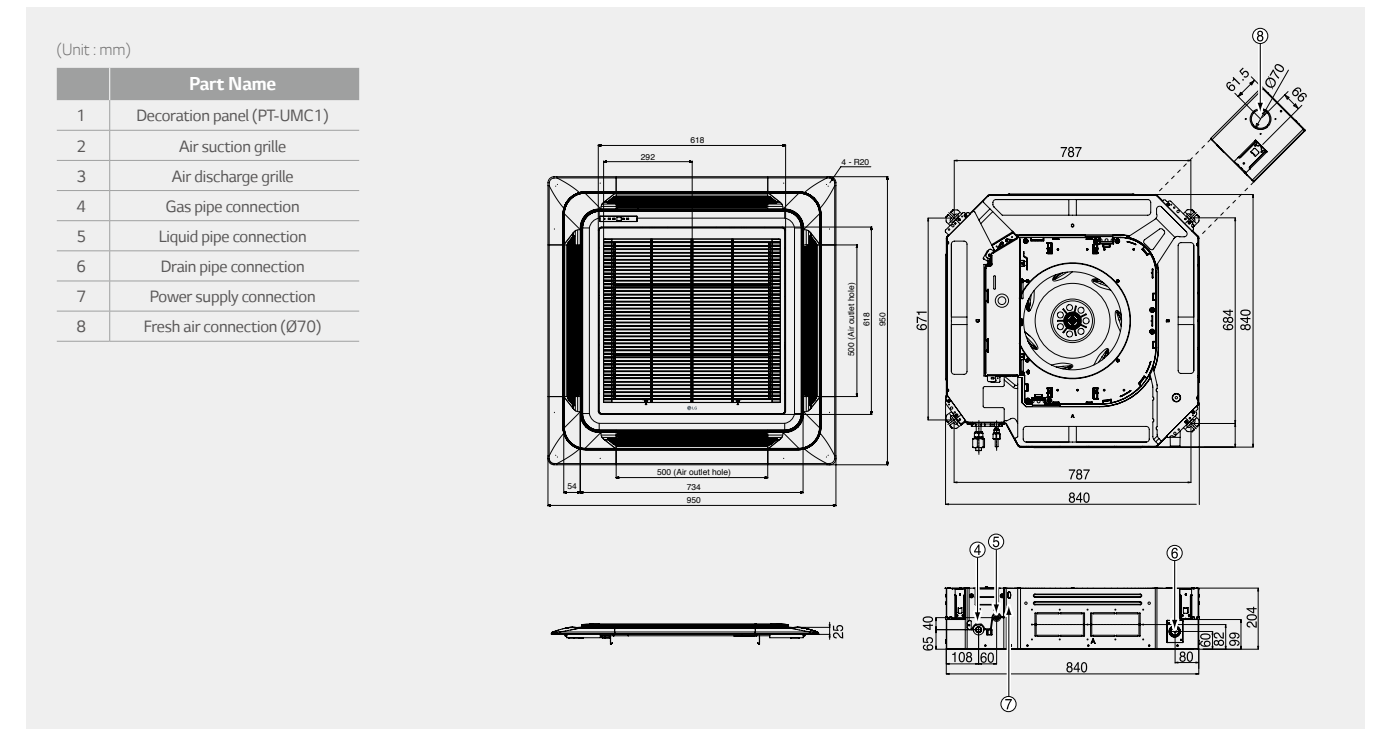

CT18 NQ4

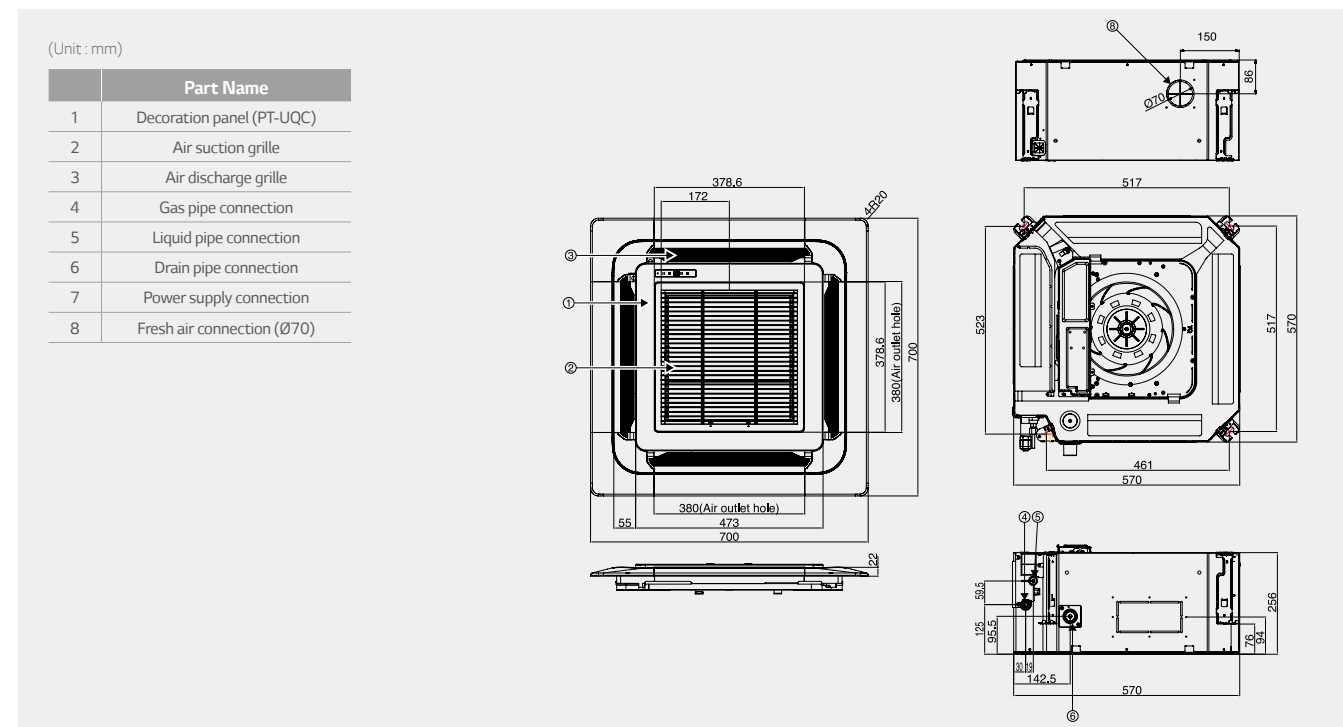

UT36 NN2

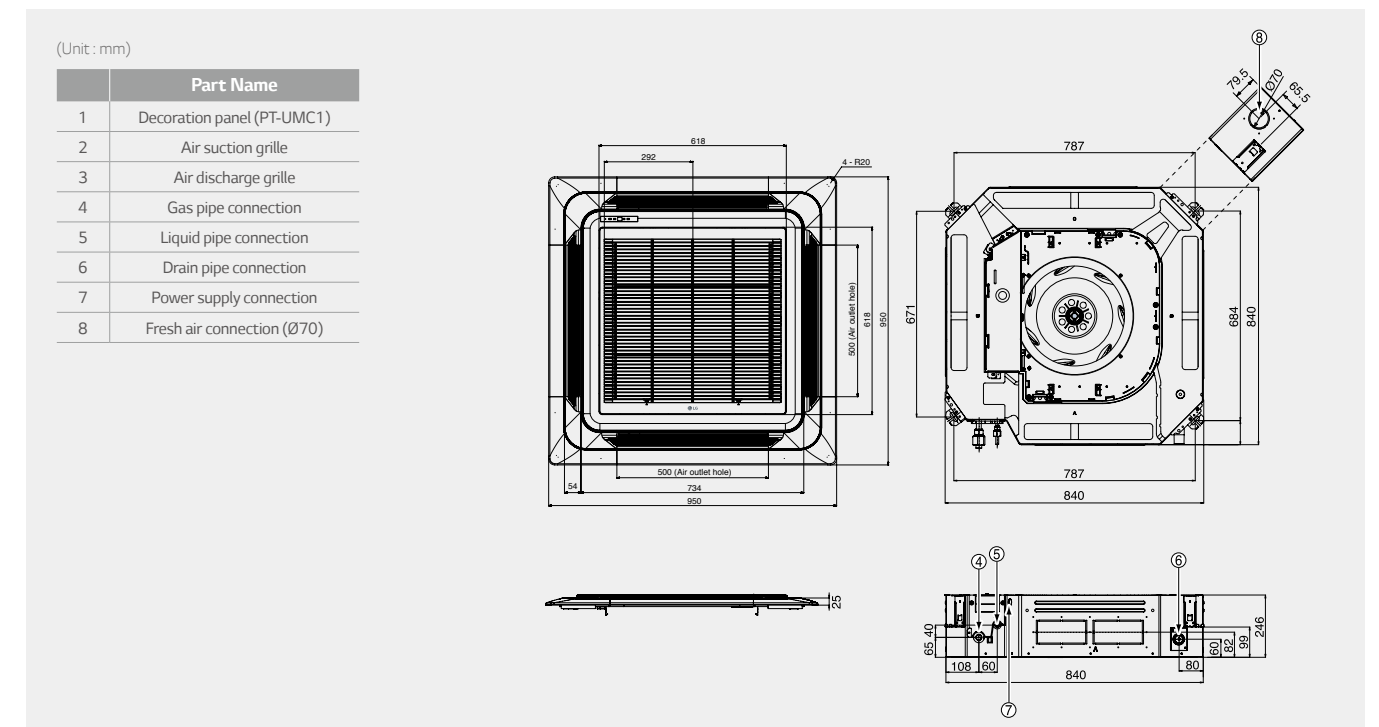

SINGLE SPLIT DIMENSIONS

CEILING CASSETTE

UT42 NM2 / UT48 NM2 / UT60 NM2

(Unit : mm)

Part Name
1 Decoration panel (PT-UMC1)
2 Air suction grille
3 Air discharge grille
4 Gas pipe connection
5 Liquid pipe connection
6 Drain pipe connection
7 Power supply connection
8 Fresh air connection (Ø70)

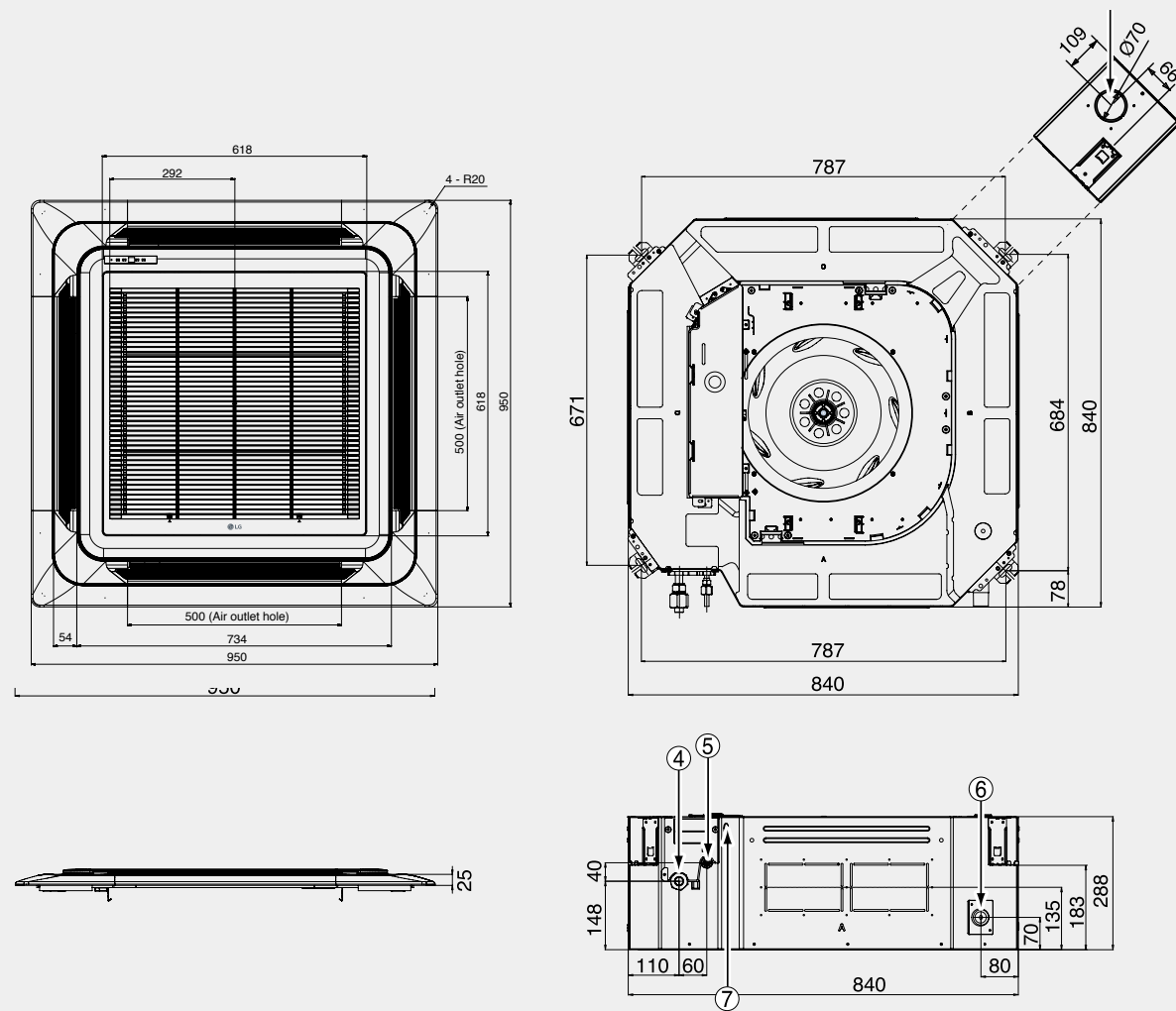

SINGLE SPLIT DIMENSIONS

CEILING CONCEALED DUCT

CB09L N12 / CB12L N22 / CB18L N22 / CB24L N32 CL09R N20 / CL12R N20 / CL18R N20 / CL24R N30

(Unit : mm)

Part Name
1 Liquid pipe connection
2 Gas pipe connection
3 Drain pipe connection
4 Power supply connection
5 Air discharge
6 Air suction

Chassis	A	B	C	D
CB09L	774	700	733	660
CB12L CB18L				
CL09R	974	900	933	860
CL12R CL18R				
CB24L CL24R	1,174	1,100	1,133	1,060

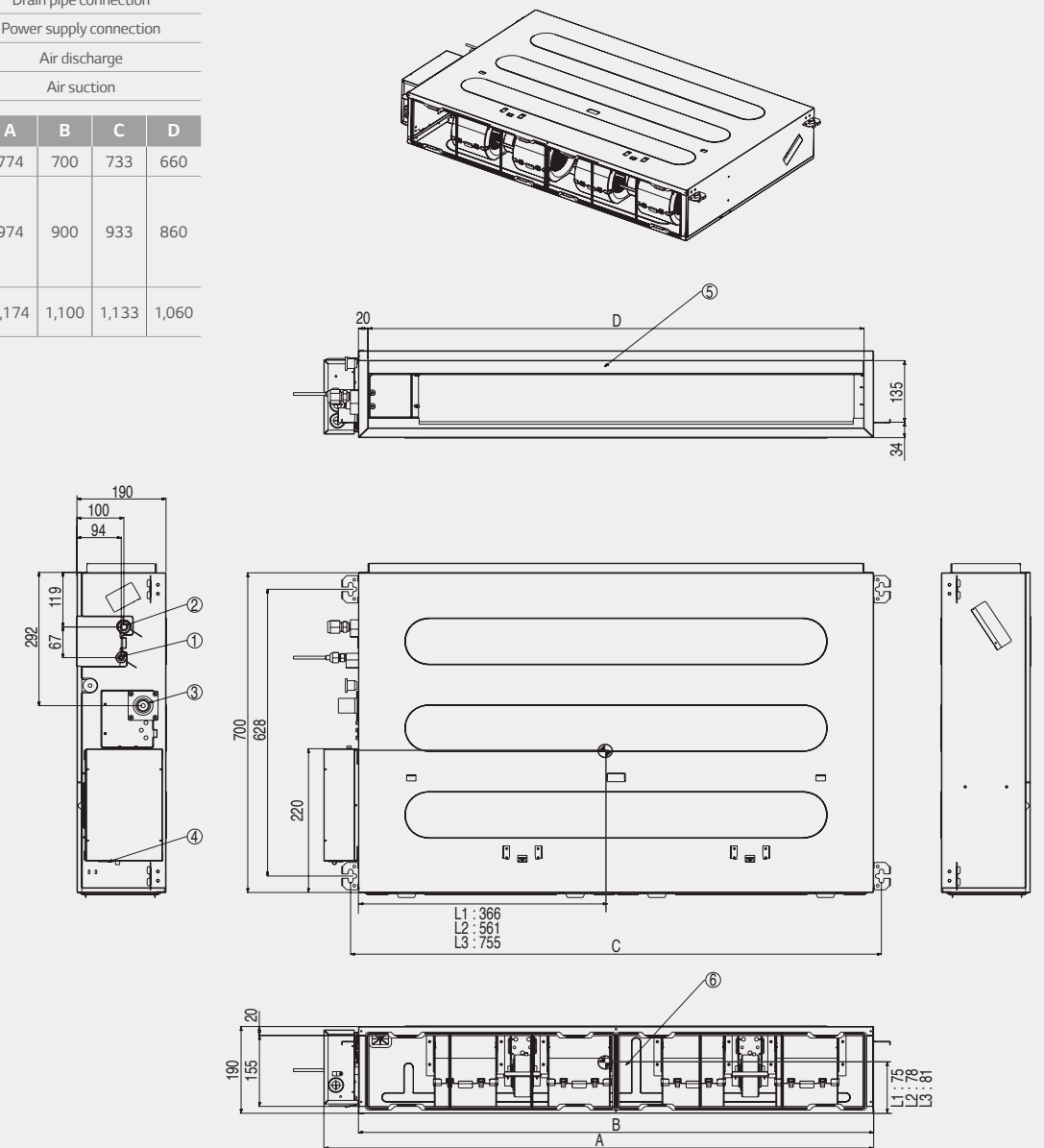

CEILING CONCEALED DUCT

CM18R N10 / CM24R N10 / UM30R N10 CM18 N14 / CM24 N14 / UM30 N14

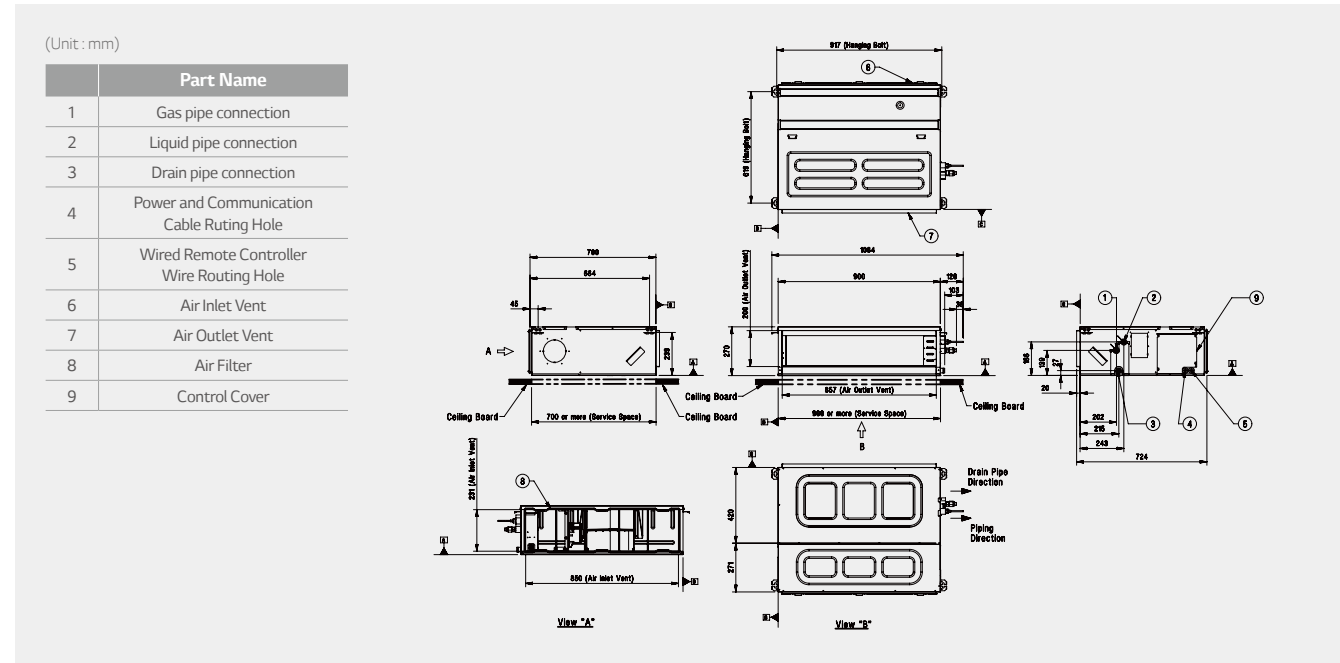

UM48 N34 / UM60 N34 / UM48R N30 / UM60R N30

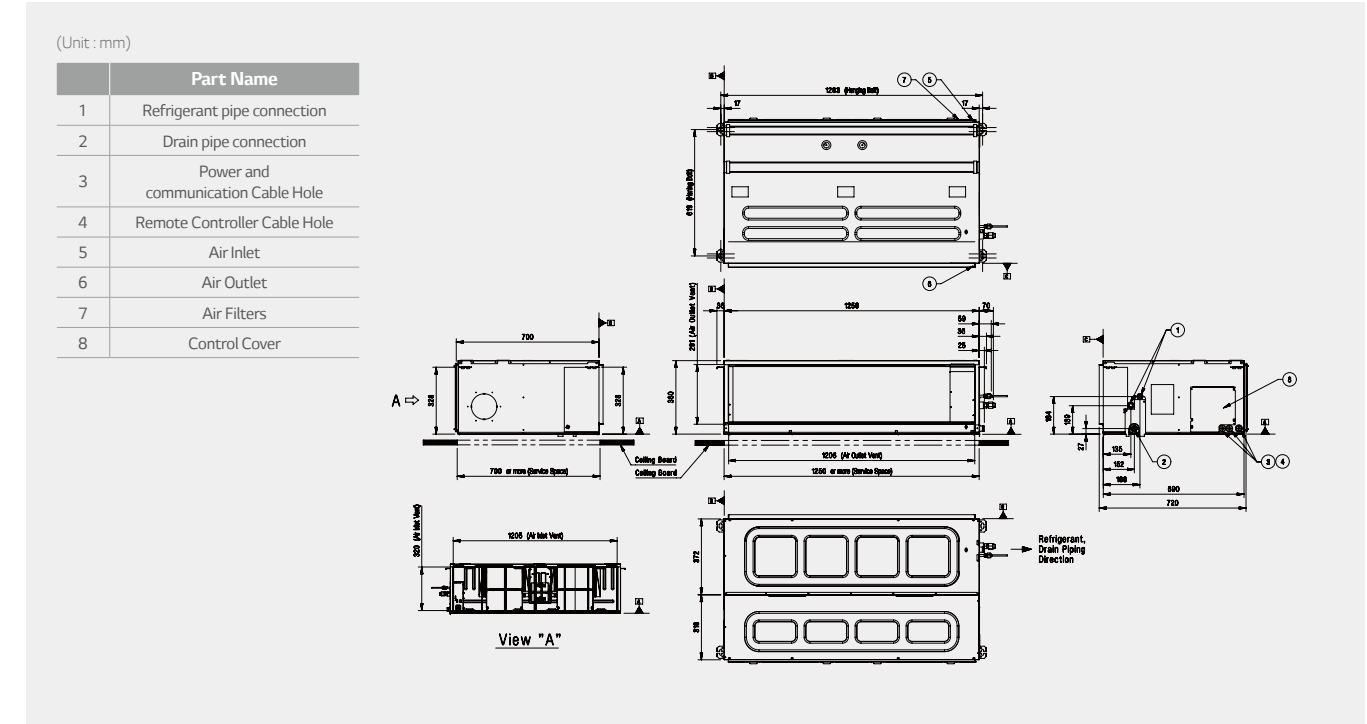

UM36R N20 / UM42R N20 / UM36 N24 / UM42 N24

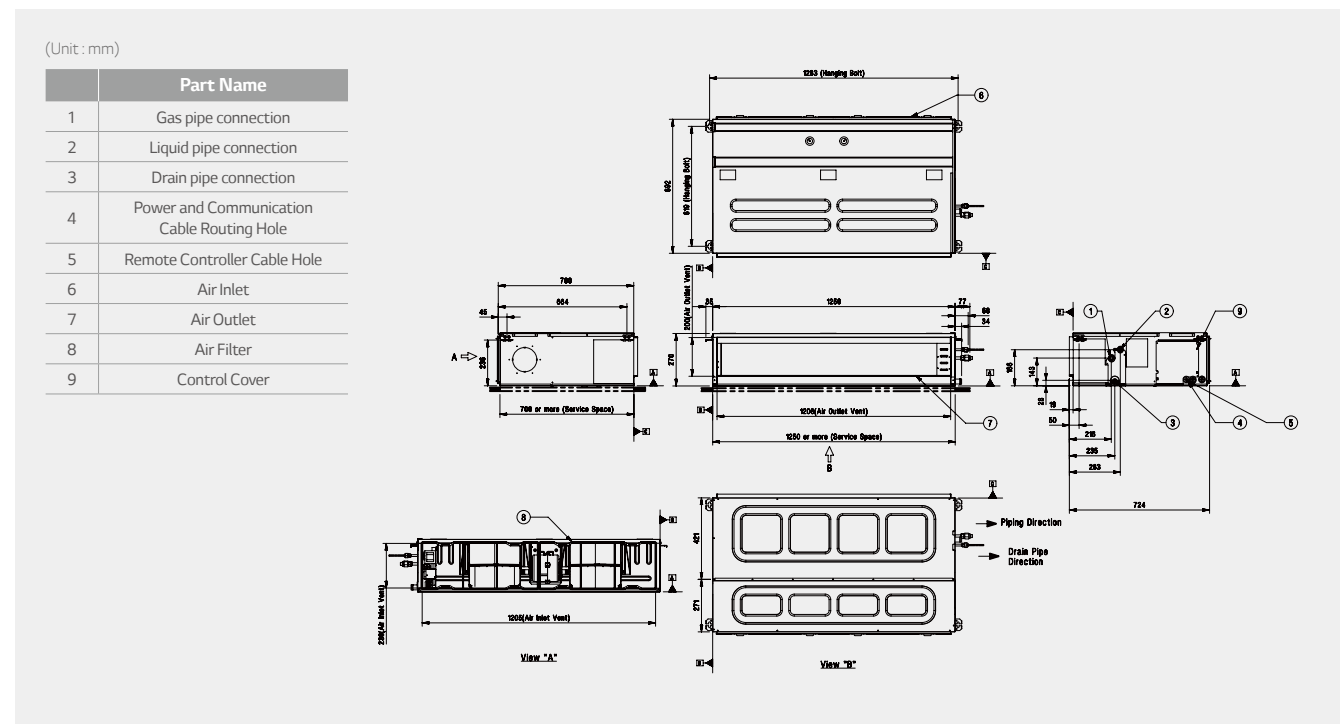

UB70 N94 / UB85 N94

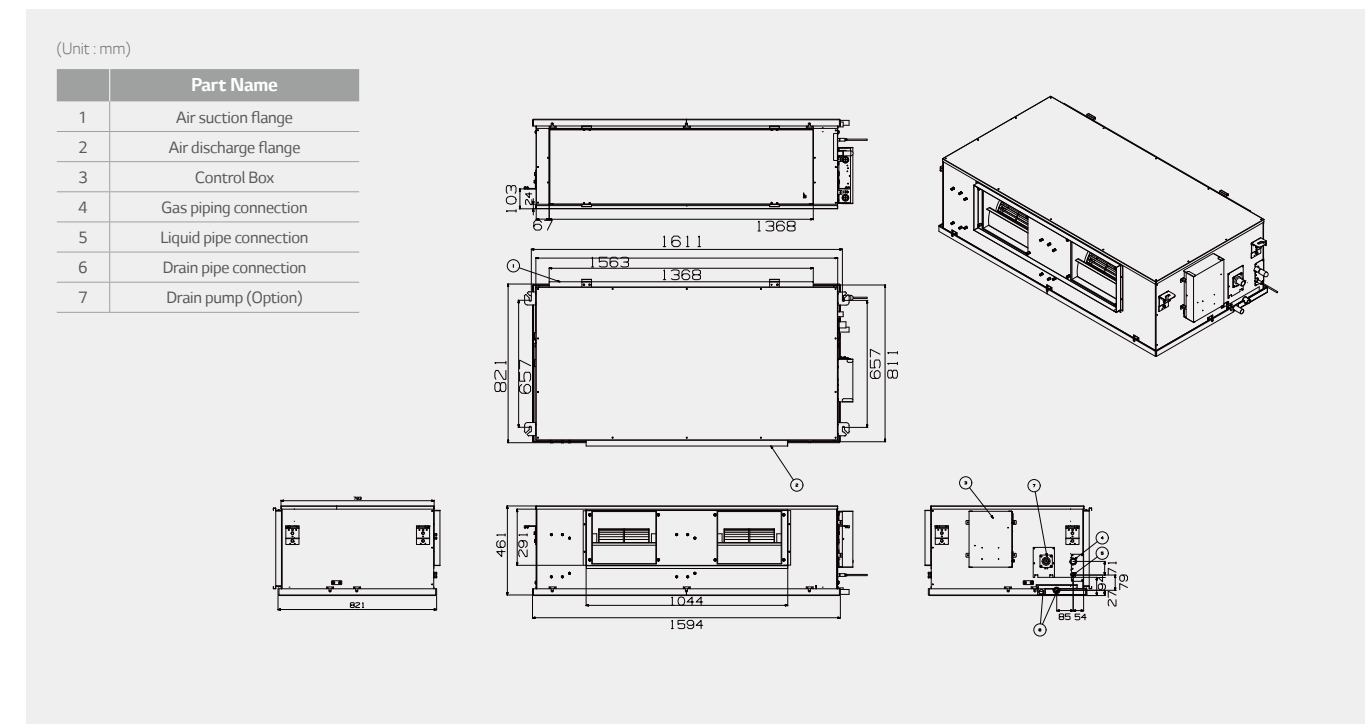

SINGLE SPLIT DIMENSIONS

CEILING CONCEALED DUCT

UB18C NH0 / UB24C NH0

(Unit : mm)

Part Name	Part Name
1	Liquid pipe connection
2	Gas pipe connection
3	Drain pipe connection
4	Power supply connection
5	Air discharge
6	Air suction

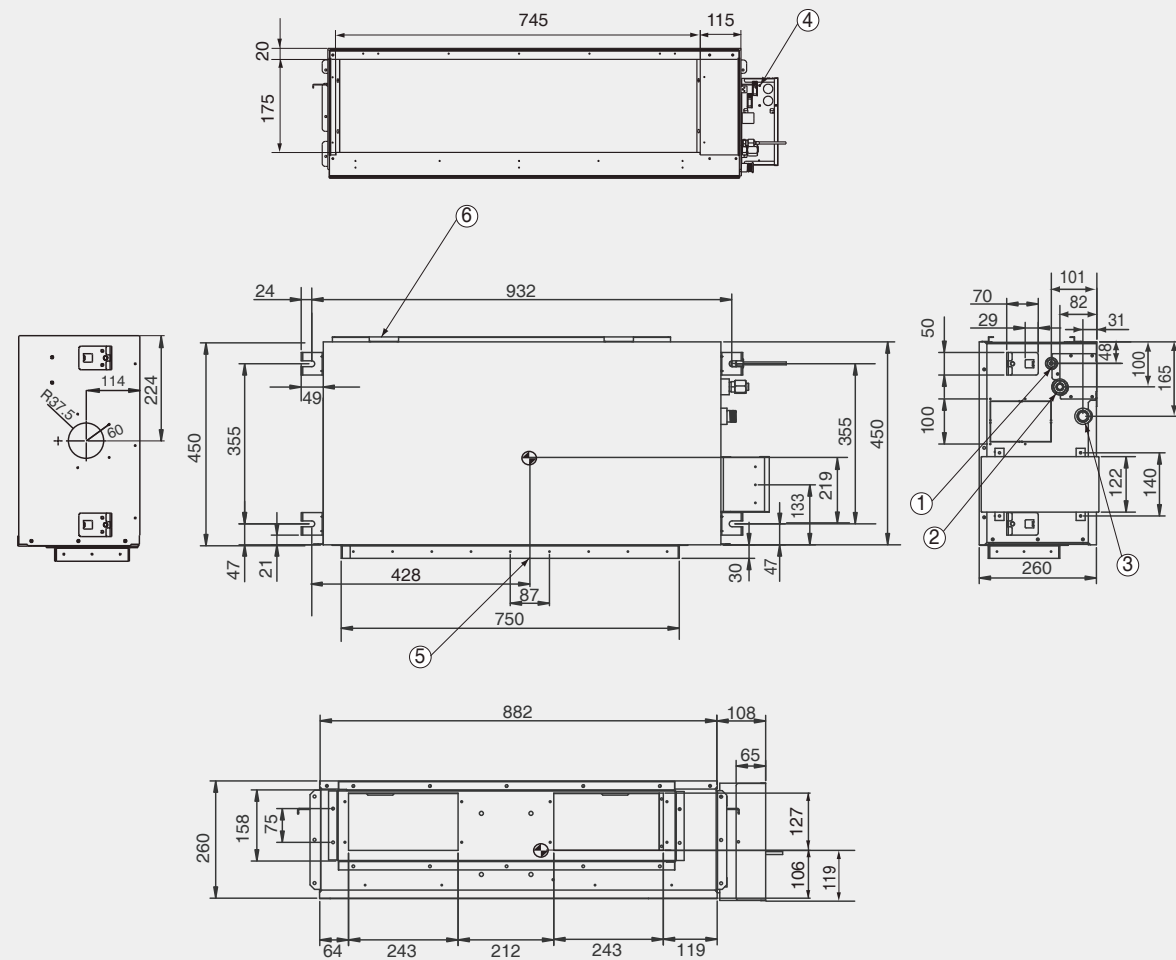

SINGLE SPLIT DIMENSIONS

WALL MOUNTED

UJ30 NV2 / UJ36 NV3

(Unit : mm)

Part Name	Part Name
1	Front Panel
2	Display & Signal Receiver
3	Air Suction Grille
4	Installation Plate

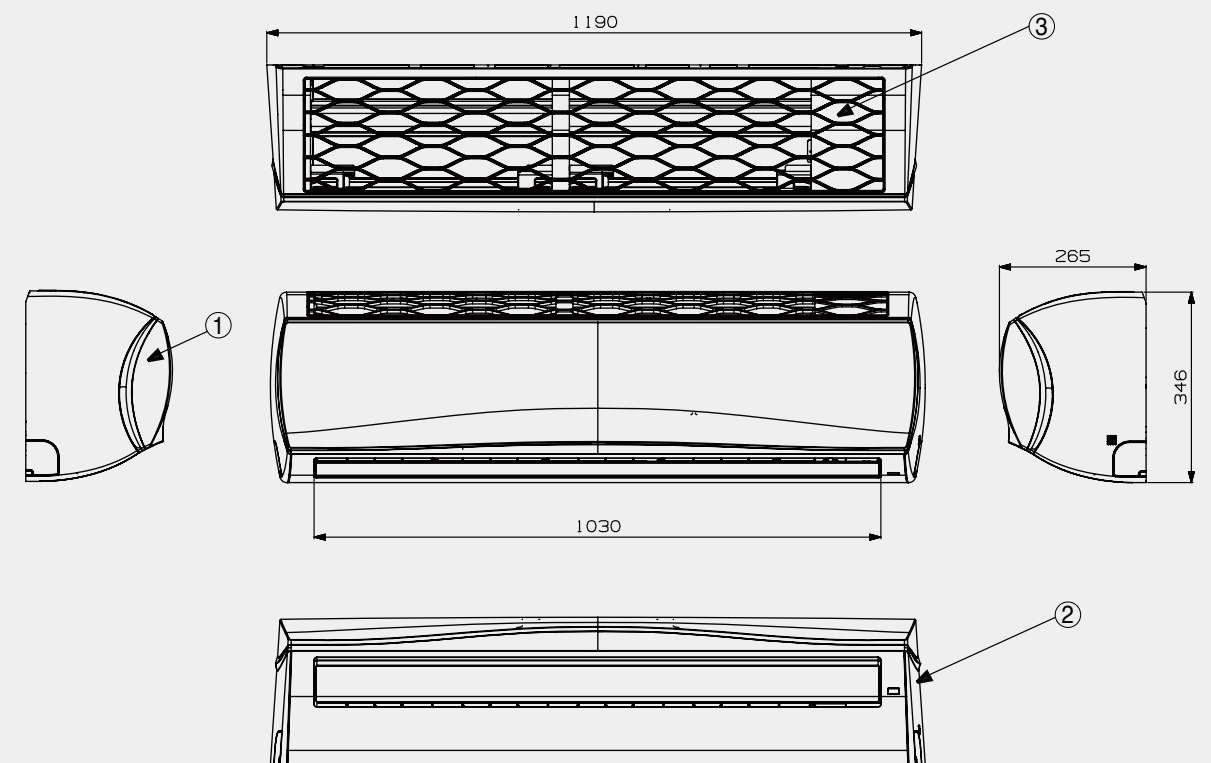

CEILING & FLOOR CONVERTIBLE

CV09 NE2 / CV12 NE2

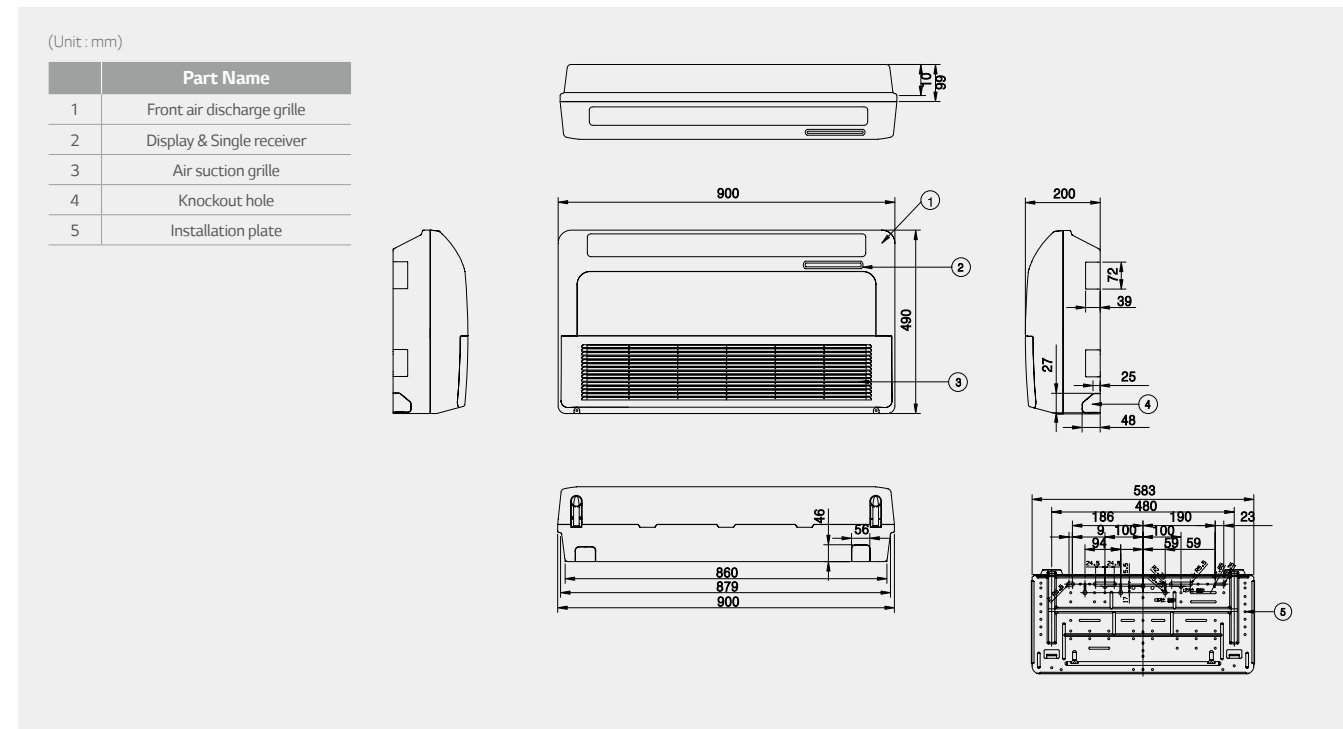

UV18R N10 / UV24R N10

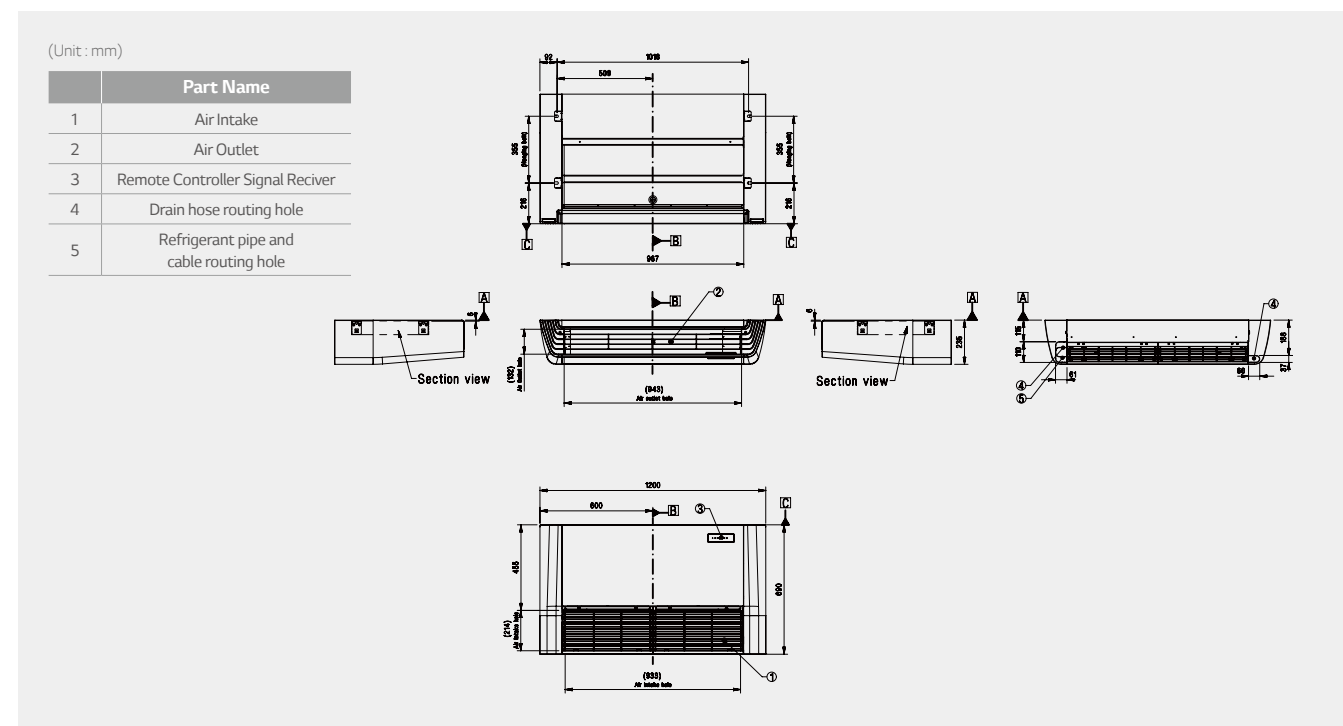

CEILING SUSPENDED UNIT

UV36R N20 / UV42R N20 / UV48R N20 / UV60R N20

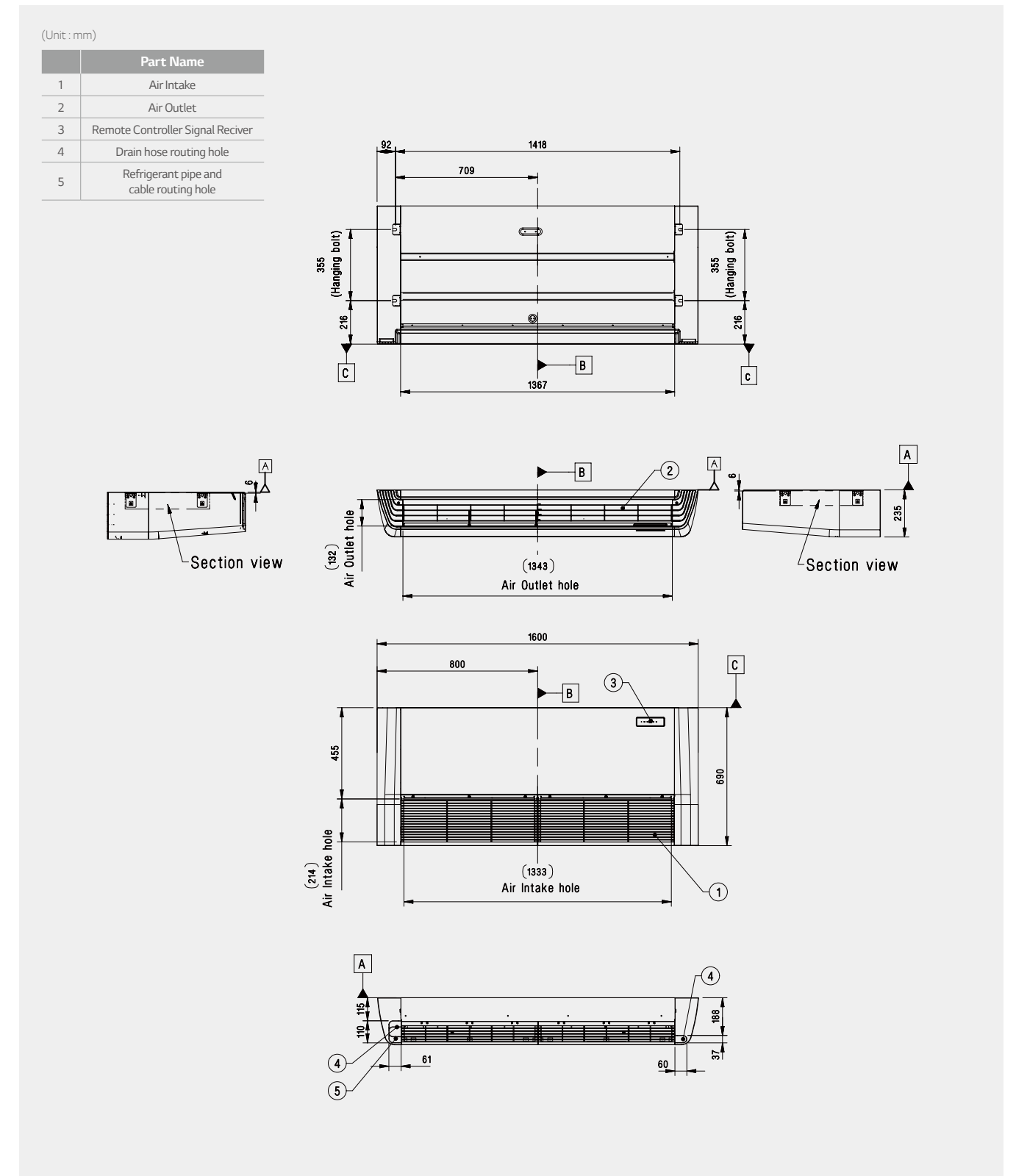

CONSOLE

CQ09 NA0 / CQ12 NA0 / CQ18 NA0

(Unit : mm)

Part Name
1 Front air discharge grille
2 Display & Single receiver
3 Air suction grille

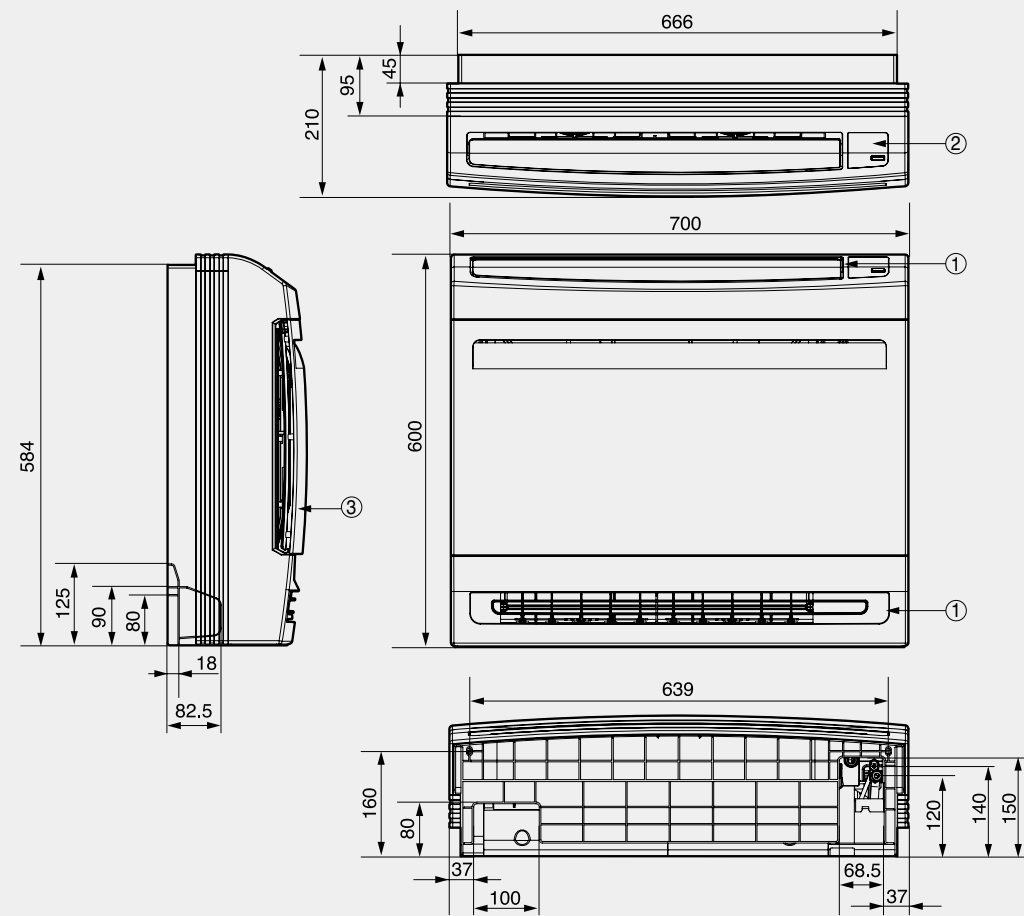

FLOOR STANDING

UP48 NT2

(Unit : mm)

Part Name
1 Front air discharge grille
2 Display & Single receiver
3 Air suction grille

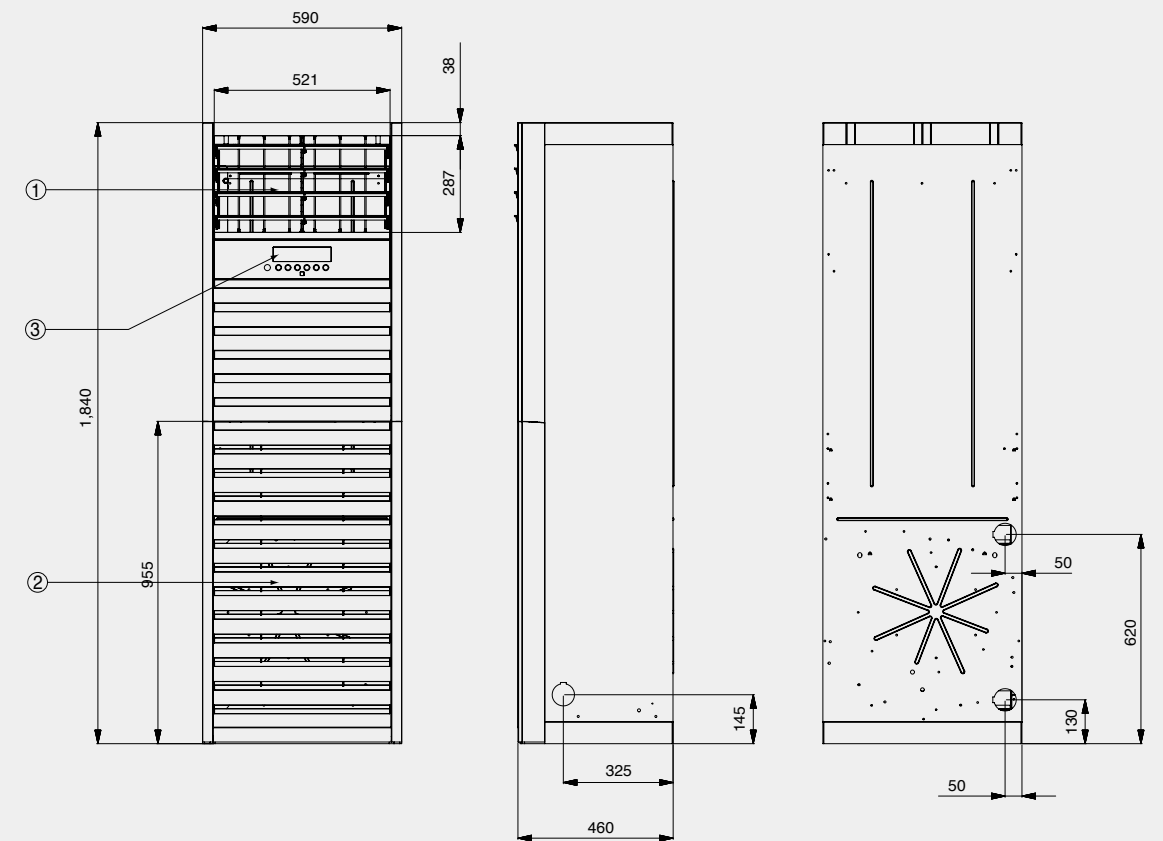

UNIVERSAL OUTDOOR

UU09WR ULO / UU12WR ULO

(Unit : mm)

Part Name
1 Air Outlet
2 Control cover & SVC valve cover
3 Power and communication cable connection
4 Gas Pipe connection
5 Liquid Pipe connection
6 Power and communication cable routing hole
7 Refrigerant pipe routing hole
8 Handle
9 Intake air temperature sensor cover

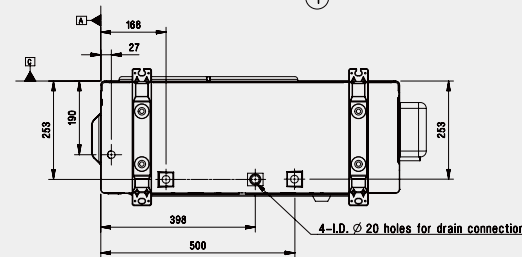
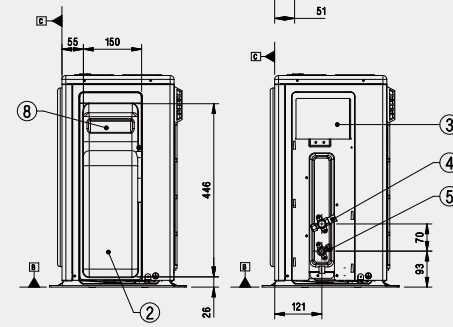
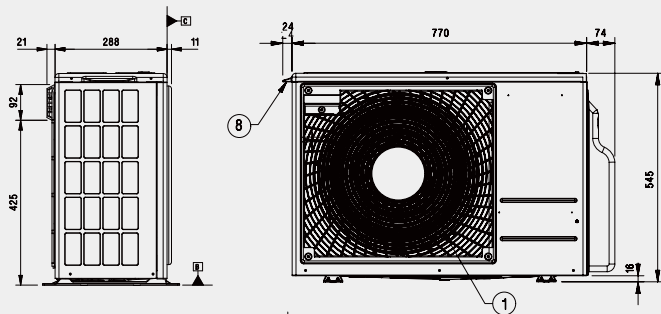
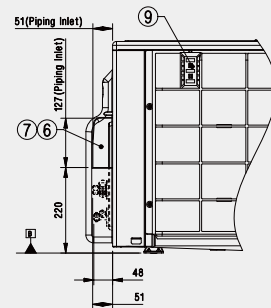
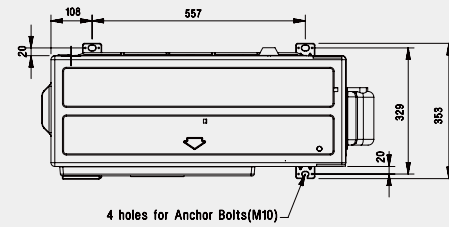
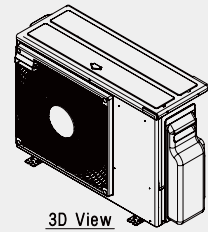

UU18WR U20

(Unit : mm)

Part Name
1 Air Outlet
2 Control cover & SVC valve cover
3 Power and communication cable connection
4 Gas Pipe Connection
5 Liquid Pipe Connection
6 Handle
7 Intake air temperature sensor cover

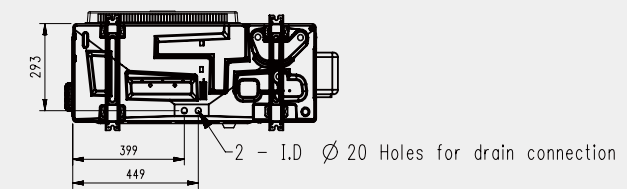
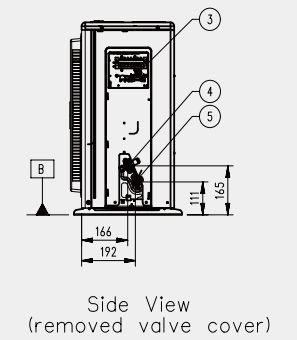
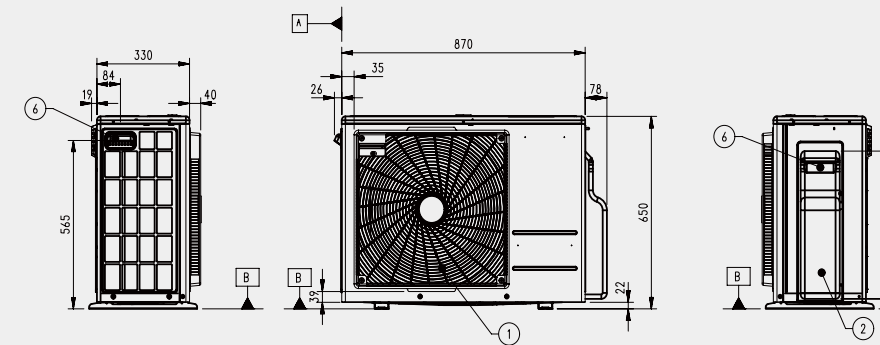
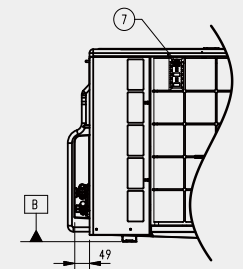
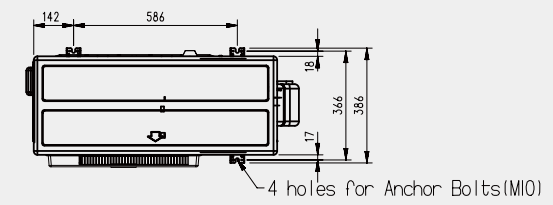
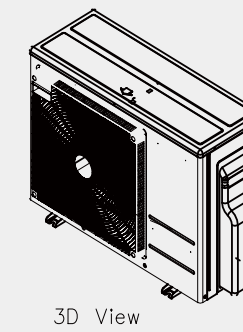

UNIVERSAL OUTDOOR

UU24WR U40

(Unit : mm)

Part Name
1 Air Outlet
2 Power and communication cable Hole
3 Gas Pipe Connection
4 Liquid Pipe Connection
5 Handle
6 Pipe routing hole (front)
7 Pipe routing hole (side)
8 Pipe routing hole (back)

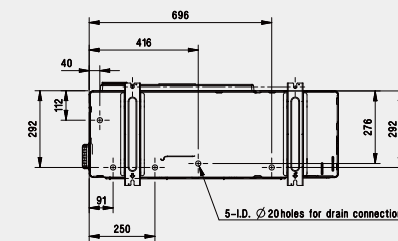
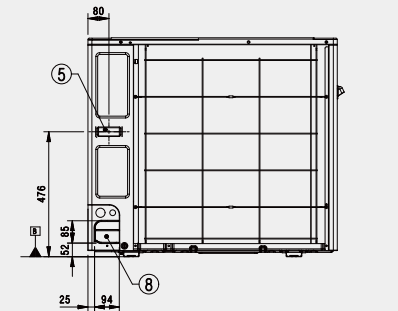
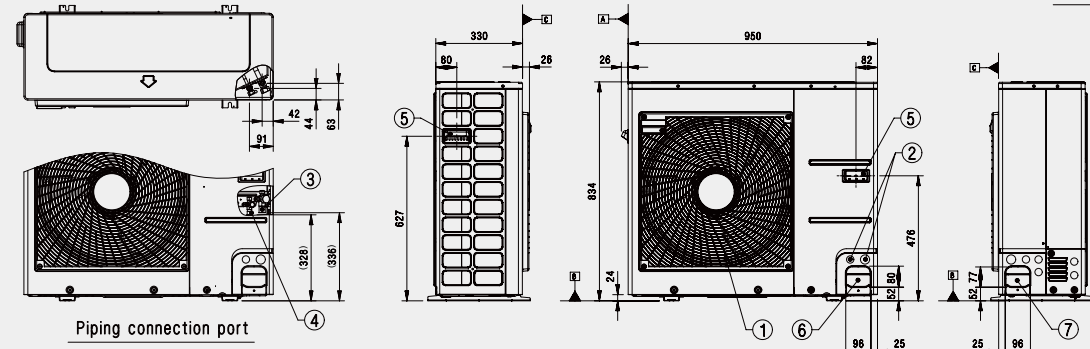
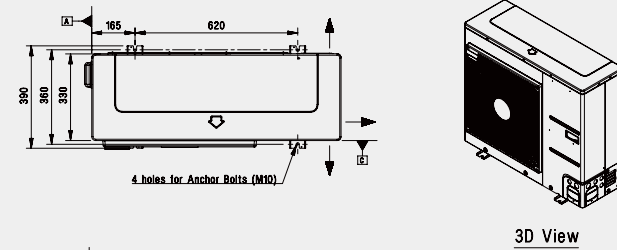

UU36WR U30 / UU37WR U30 / UU42WR U30 / UU43WR U30 UU48WR U30 / UU49WR U30 / UU60WR U30 / UU61WR U30

(Unit : mm)

Part Name
1 Air Outlet
2 Power and communication cable hole
3 Gas Pipe Connection
4 Liquid Pipe Connection
5 Handle
6 Pipe routing hole (front)
7 Pipe routing hole (side)
8 Pipe routing hole (back)

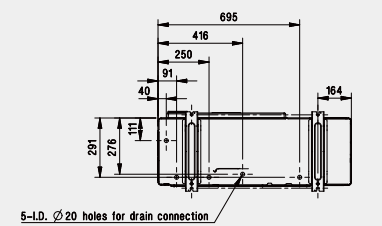
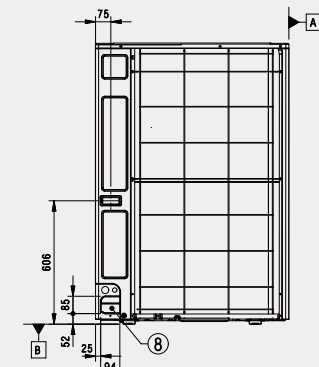
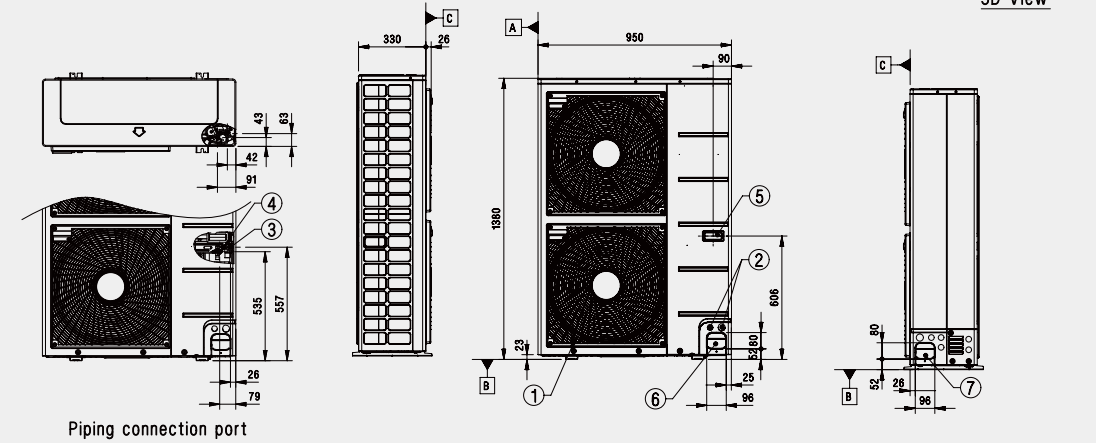
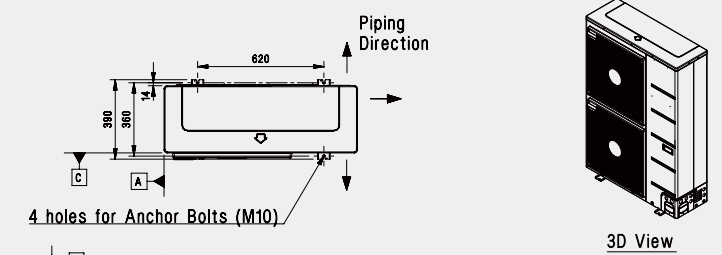

UNIVERSAL OUTDOOR

UU24W U44 / UU30W U44 / UU36WC U40

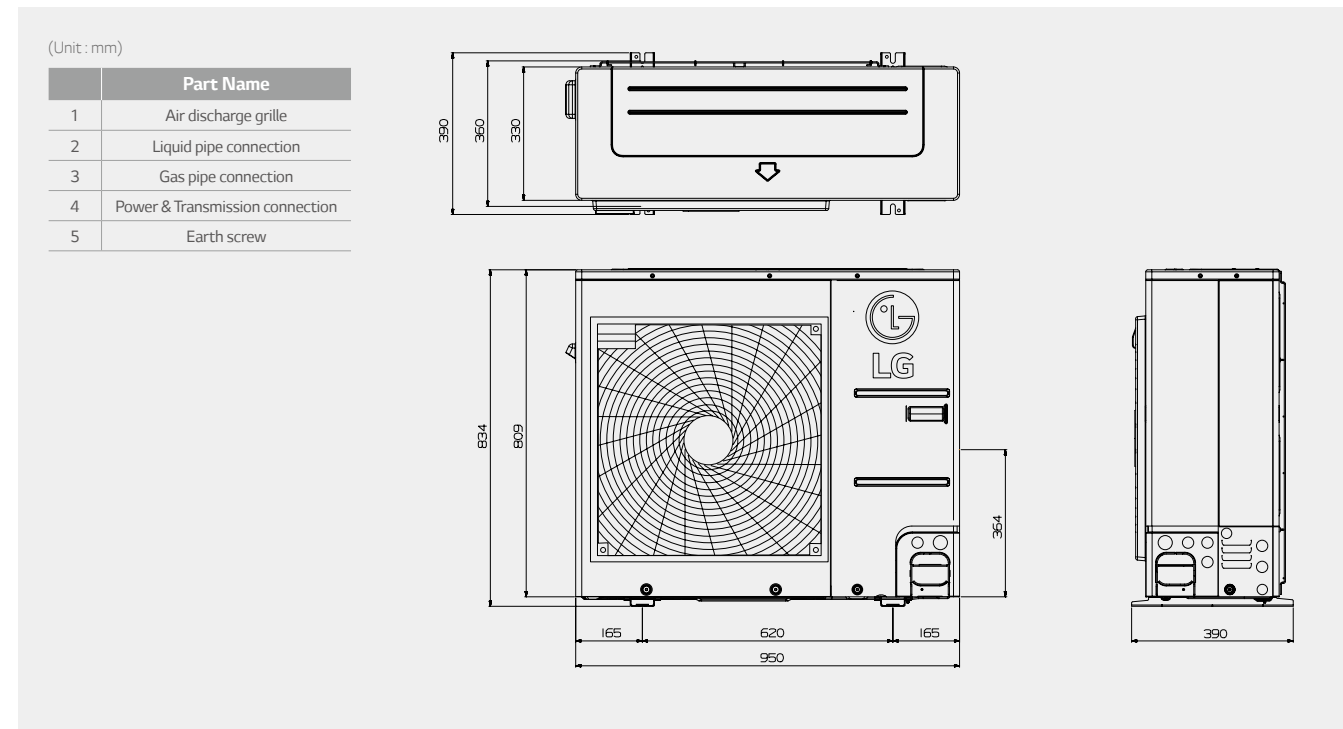

UU09W ULD / UU12W ULD



UU42W U32 / UU48W U32 / UU60W U32 / UU43W U32 / UU49W U32 / UU61W U32 / UU70W U34

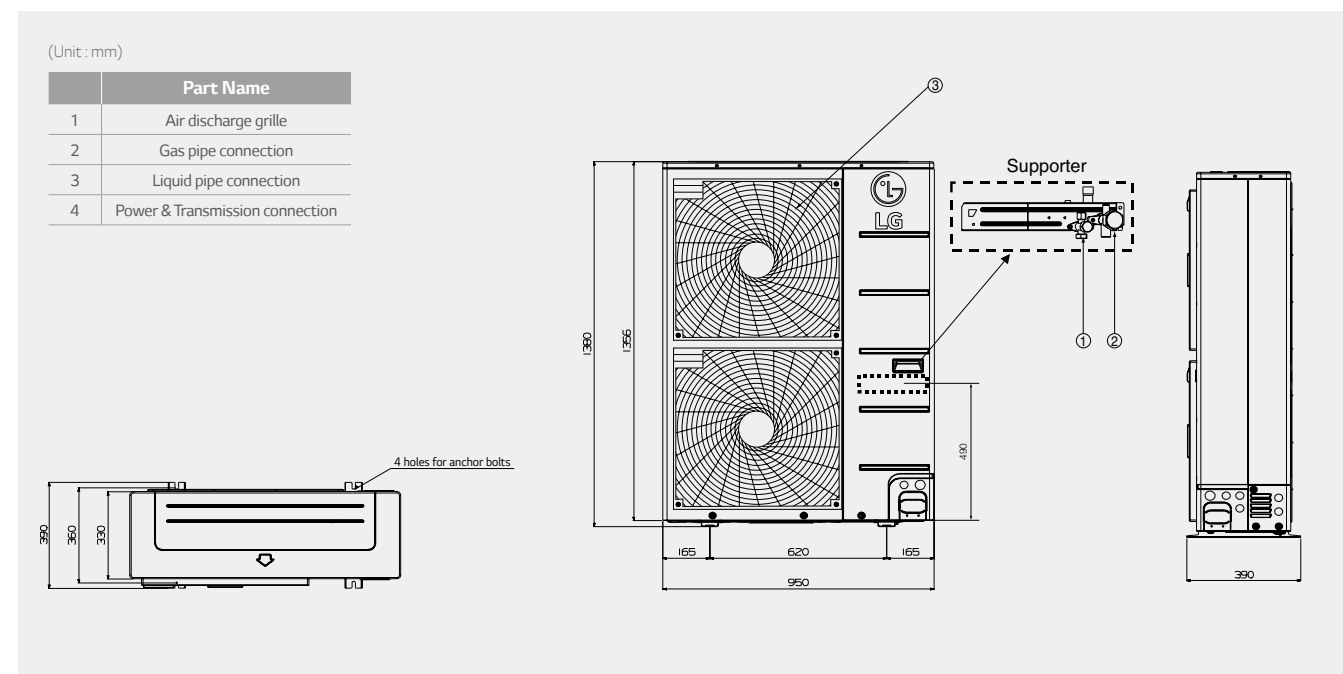

UU18W UE4

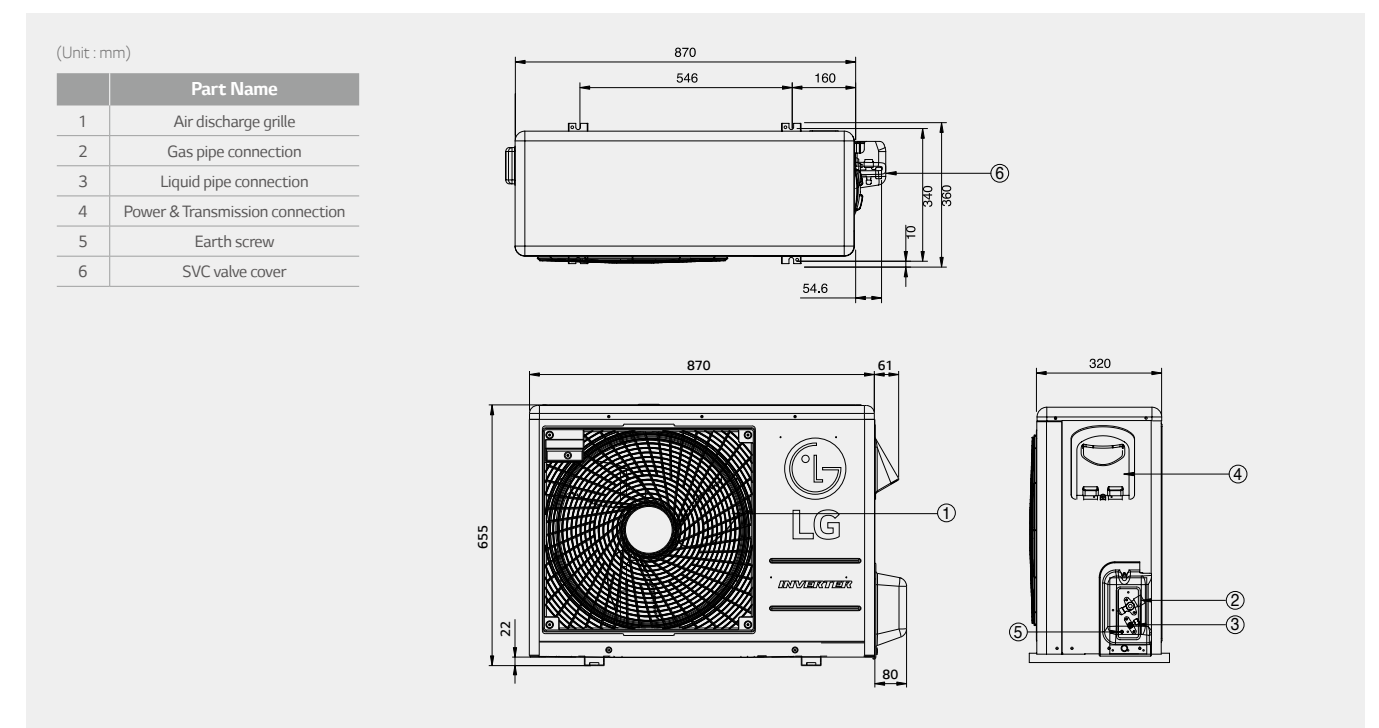

HEATING

MONOBLOC (LOW TEMPERATURE)
SPLIT (HIGH TEMPERATURE)
DOMESTIC HOT WATER TANK

SPLIT (LOW TEMPERATURE)
SPLIT (DHW TANK INTEGRATED)
ACCESSORIES



WHAT IS THERMA V

What is LG THERMA V?

THERMA V is LG's Air to Water Heat Pump system, especially designed for new and renovated housings. It is an in-house design by LG's advanced heating technology consuming less energy.

THERMA V can be used as a multi-purpose heating Solution ranging from floor heating to hot water supply using various heat sources.



Energy Efficient Application

THERMA V offers the best solution for home heating and hot water supply with LG's inverter technology. It is 4 times more energy efficient than the traditional boiler system by absorbing energy from the outdoor environment.

• AIR SOURCE

- Free energy
- Green energy
- Easy energy

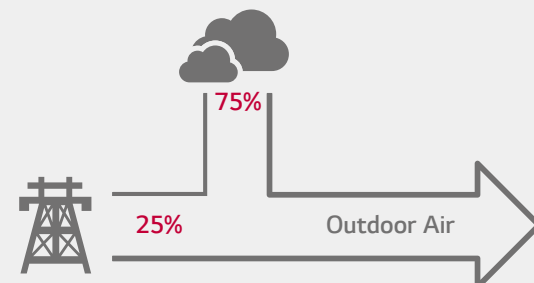

Optimal Application

Advanced model selection software enables designers to choose optimal THERMA V model based on the location and environmental factors.

• Model selection screen

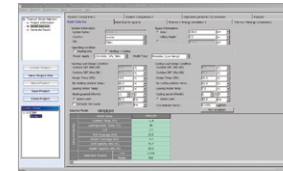

• Monthly energy simulation

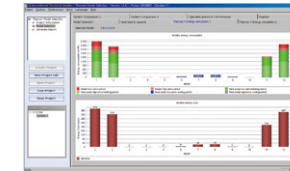

• Heat load & heat pump capacity

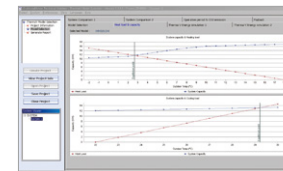

• System comparison chart

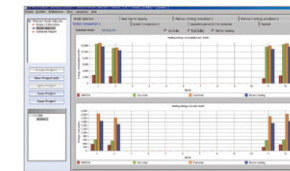

Reliable Application

Heating range for outdoor temperature is down to -20°C and leaving water temperature can reach max. 57°C

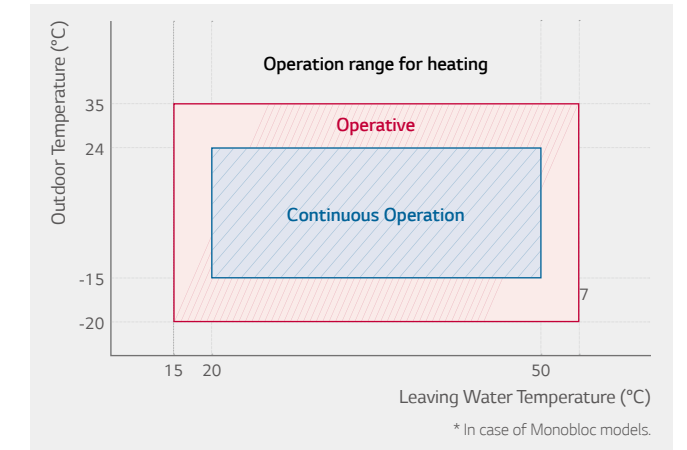

Various Application

Various kinds of application is possible with THERMA V units including new house also renovation house.

• New House

With low temp. monobloc & split model, heating and cooling can be ensured.

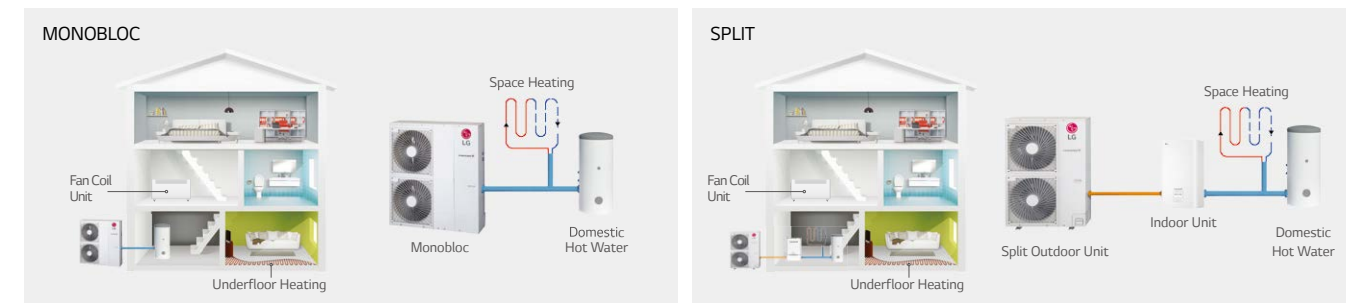





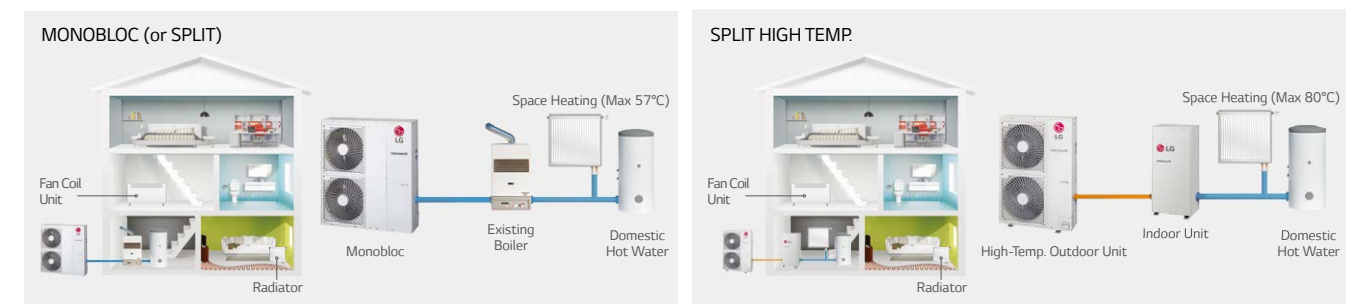

• Renovation House







THERMA V can be connected to existing boiler system to optimize energy efficiency and heating capacity for renovation house. Also THERMA V High Temperature can provide equivalent water heating to a boiler of up to 80°C.



LINE-UP

THERMA V

Type	Phase	1Φ	1Φ	1Φ	1Φ	1Φ	1Φ	3Φ	3Φ	3Φ
	kW	5	7	9	12	14	16	12	14	16
Monobloc Type		HM051MU42	HM071MU42	HM091MU42						
					HM121MU32	HM141MU32	HM161MU32	HM123MU32	HM143MU32	HM163MU32
Split Type		HN1616.NK3	HN1616.NK3	HN1616.NK3						
		HU051.U43	HU071.U43	HU091.U43						
					HN1616.NK3	HN1616.NK3	HN1616.NK3	HN1639.NK3	HN1639.NK3	HN1639.NK3
					HU121.U33	HU141.U33	HU161.U33	HU123.U33	HU143.U33	HU163.U33

Type	Phase	1Φ	1Φ	1Φ	1Φ	1Φ	1Φ	3Φ	3Φ	3Φ
	kW	5	7	9	12	14	16	12	14	16
Split DHW Tank Integrated Type				HN1616.TNB0						
				HU091.U43						
					HN1616.TNB0	HN1616.TNB0	HN1616.TNB0	HN1616.TNB0	HN1616.TNB0	HN1616.TNB0
					HU121.U33	HU141.U33	HU161.U33	HU123.U33	HU143.U33	HU163.U33
Split High Temp. Type							HN1610H.NK2			
							HU161HU32			

LG THERMA V



Why LG THERMA V?

The LG THERMA V is designed to provide reasonable benefits such as like energy saving, comforts, easy controls and services by applying the advanced technologies.

The LG Inverter Technology provides excellent energy efficiency with optimal components such as water pump, heat exchanger and fan motor. Moreover, the pressure control technology provides stable heating capacity at a low temperature and reaches target performance without difficulties.

Additionally, the amalgamated model where all-in-one features are combined such as gold-fin and users-oriented functions. This has resulted in boosting professional reputation and enhancing end-user's experience in the form of LG's full line-up from 5kW to 16kW in heating capacity.

ENERGY EFFICIENCY

BLDC (Brushless Direct Current Motor) Compressor

THERMA V is equipped with a BLDC compressor that uses a strong neodymium magnet. The compressor has improved efficiency compared to standard AC inverter product and it is optimized for seasonal efficiency.

- Minimized oil circulation
- High efficiency motor
- Optimized compression
- Optimized vibration, noise
- High reliability

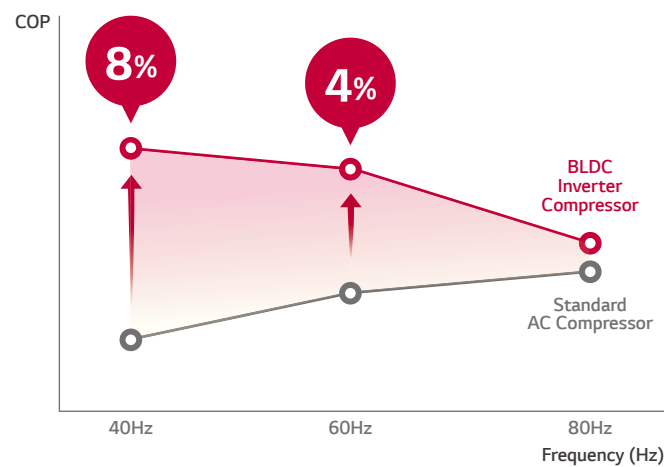

Power input saving by High efficient A-Class water pump

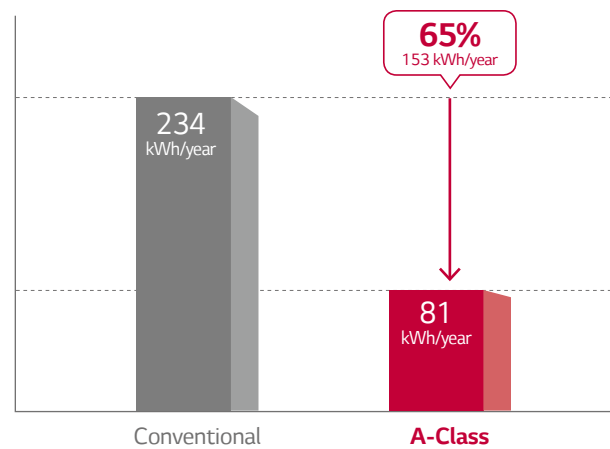

* Condition: 12 hours x 30 days x 5 month (estimated value)

Only THERMA V Monobloc applied

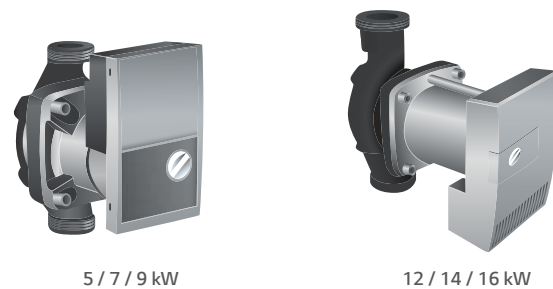

Energy Efficiency at -2°C

Energy efficiency is higher than others. (Condition: Ambient temp. -2°C / Leaving water temp. 55°C)

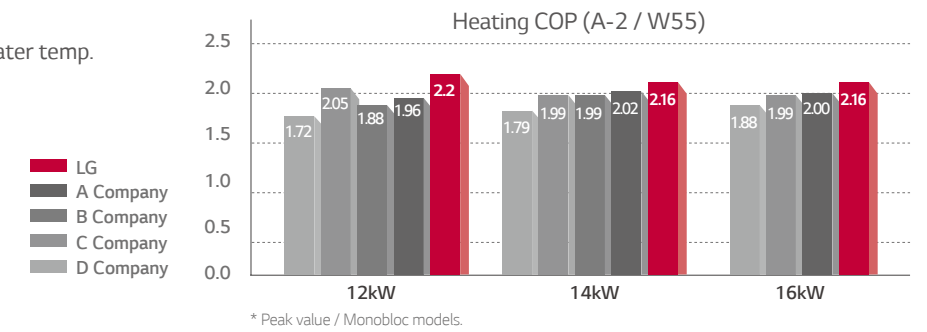

Heat Exchanger Improvement

Efficiency and performance are improved by increased heat exchange rate of wide lower fin & new optimal distributor design applied to the heat exchanger.

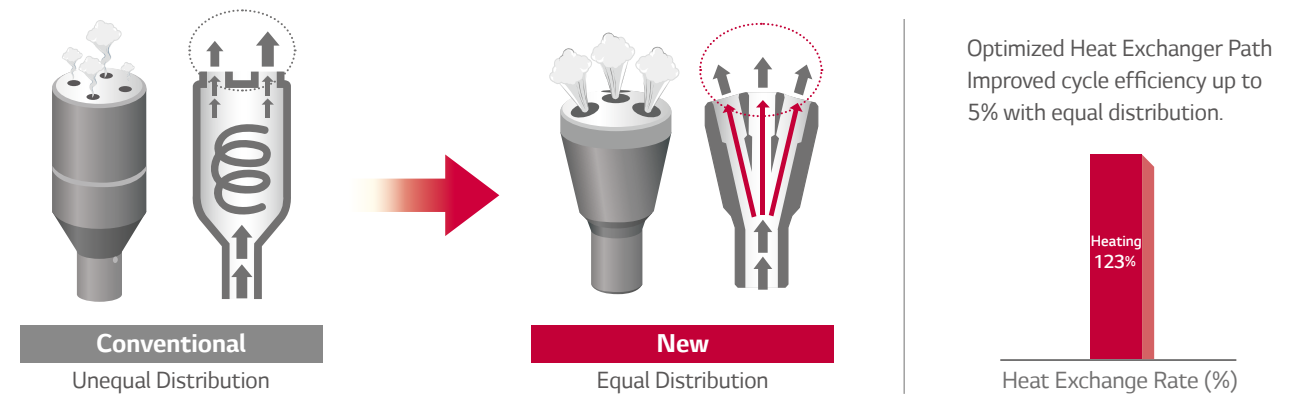

Inverter BLDC Fan Motor

LG BLDC fan motor offers additional energy savings up to 40% at low speed and 20% at high speed compared to an AC motor.

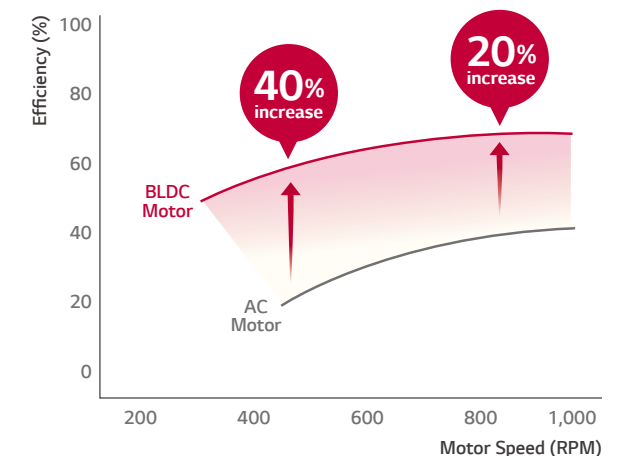

RELIABILITY

Reliability at Low Temperature

Pressure control reinforces heating performance by operating in stable condition at low ambient temperature.

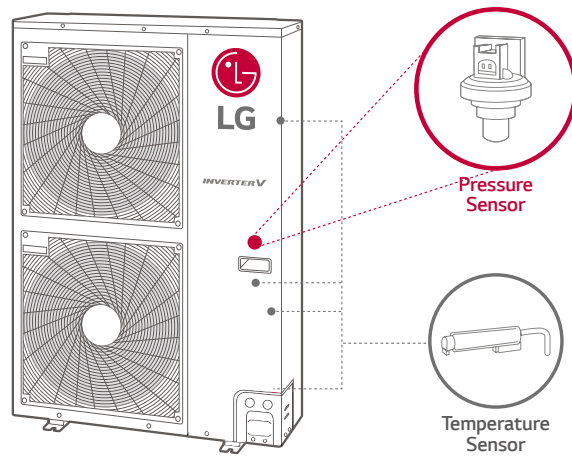

Temperature Control

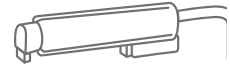

Temperature Sensor Only

This algorithm is more likely to be affected by temperature change and it takes more time to calculate proper operation range of compressor to target point.

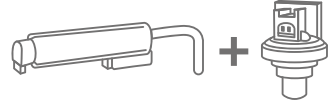

Temperature Sensor + Pressure Sensor

This ensures to reach target performance point without failing to keep a reliable operation.

• Heating Capacity at Low Temperature

High and stable performance at low temperatures.

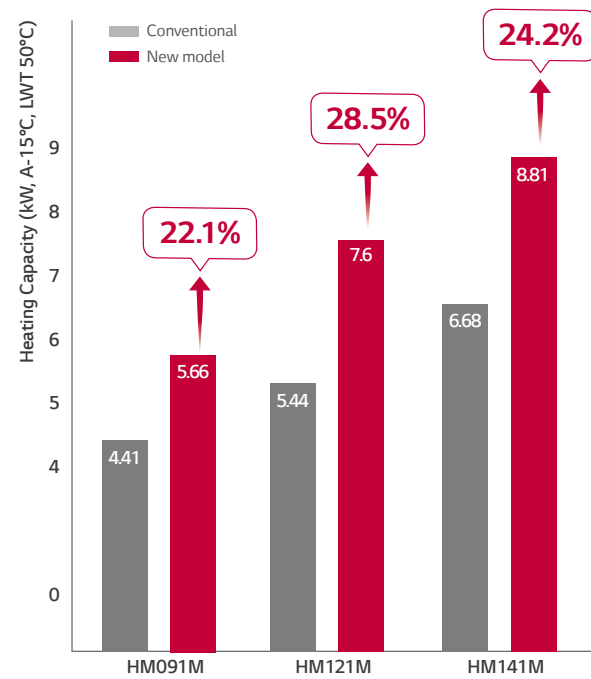

• Stable Operation

High and stable heating performance at low temperatures.

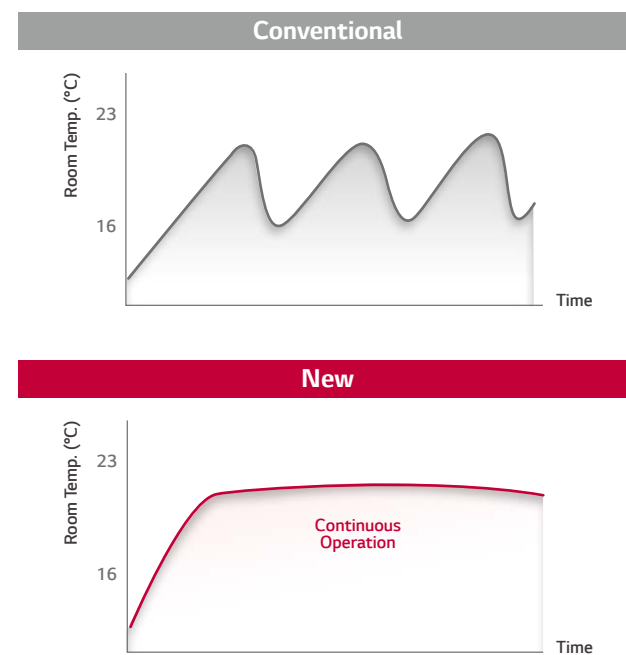

Corrosion Resistant Heat Exchanger

LG's Outdoor Heat Exchanger is coated with a gold-colored anti-corrosive epoxy treatment on the aluminum coil, to prevent corrosion. This exhibits pre-eminent heat transfer properties of the coil for a lengthy period, whereas non-Gold Fin™ coils progressively lose efficiency due to surface corrosion. Gold Fin™ fin is extremely suitable for areas affected by high pollution and areas exposed to salt water breeze.

• Composition of Fin Screens

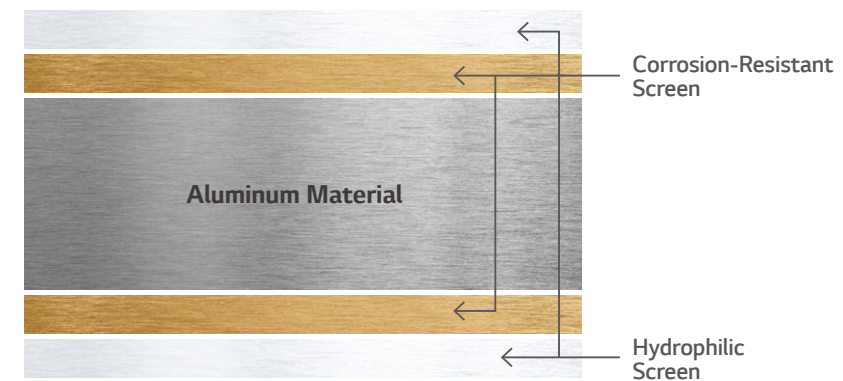

• Salt Spray Test for 15 Days

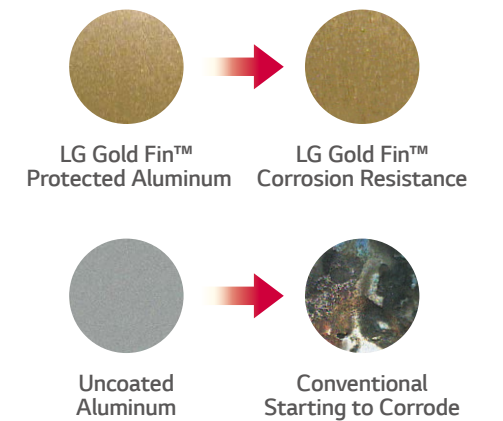

• Gold Fin is long lasting, durable and makes the Outdoor Unit look prestigious.

Anti-Legionella Function

By setting Anti-legionella operation mode ON, THERMA V heats the whole water tank automatically once a week until the water temperature reached up to 80°C.

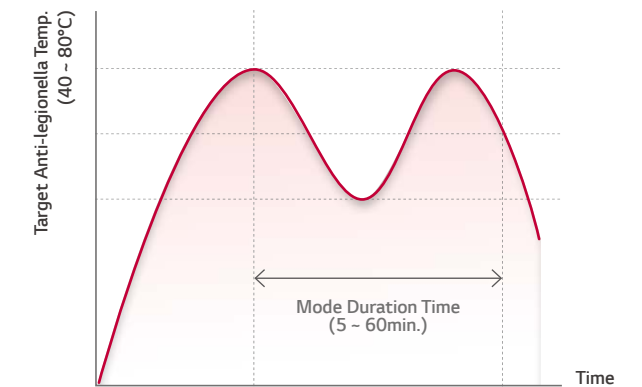

CONVENIENCE

Seasonal Auto Mode

In this mode, the target temperature will vary according to the outdoor temperature automatically. This mode adds the cooling season function to the conventional weather dependent operation mode.

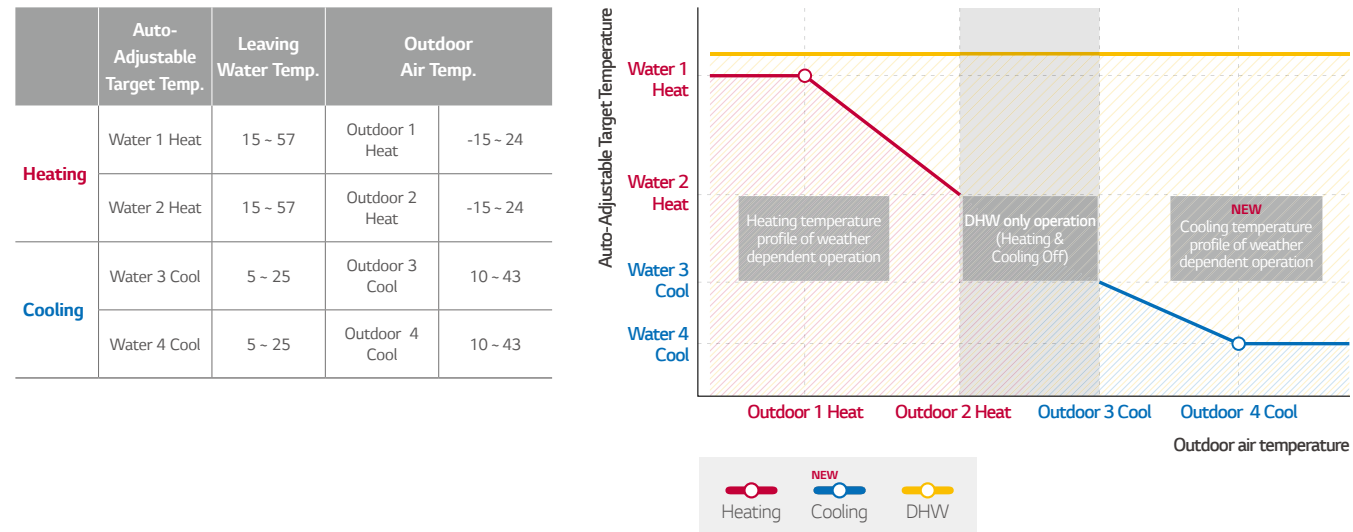

Improved Fan for Low Noise

The New Axial Fan has a narrow hub blade and mogul trailing edge, this provides a high efficiency, low noise as well as improving the air flow rate.

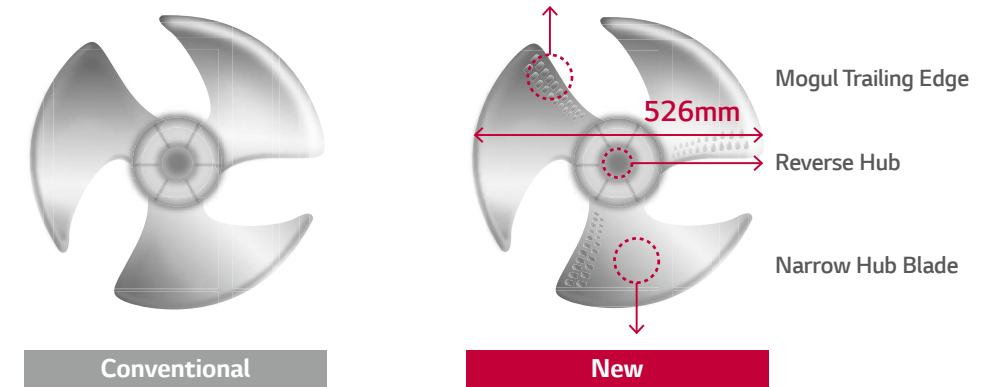

Emergency Operation

Even in case of sudden product error, THERMA V ensures stable heating operation by applying 2 steps of emergency control.

- Minor Error** (Mainly caused by sensor)
 - THERMA V - On
 - Electric Heater - On/Off
- Major Error** (Mainly caused by cycle parts)
 - THERMA V - Off
 - Electric Heater - On

Conventional

LG THERMA V

Silent Mode & Scheduler

Silent mode operation can reduce the noise level by remote controller and users can set the weekly On / Off schedule too.

Heating Capacity (kW)	Heating Sound Pressure (dBA)	
	Normal	Silent Mode
3	47	43
5	51	48
7	52	48
9	52	48
12	53	50
14	53	50
16	53	50

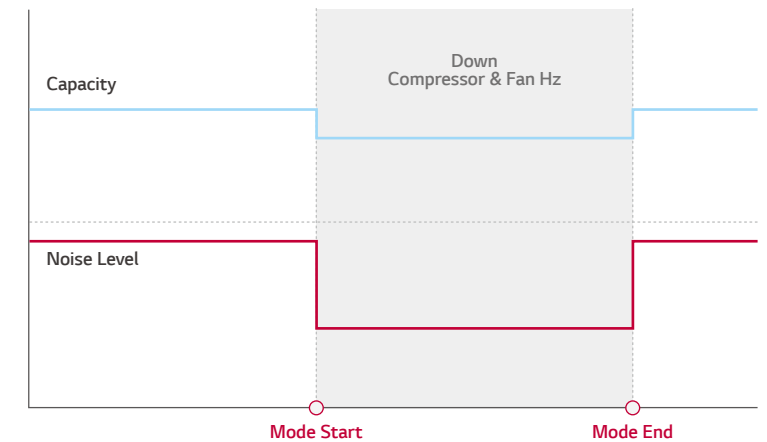

EASY INSTALLATION & SERVICE

All in One Concept

LG will provide fully packaged monobloc with 4 main component. (except 3kW monobloc) basically. No need to work refrigerant piping, easier and quicker installation.

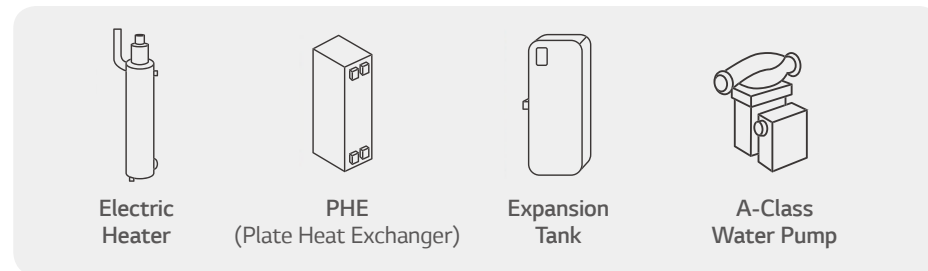
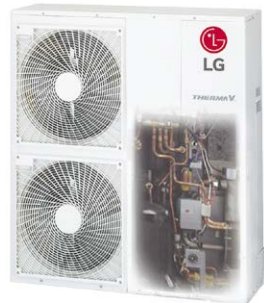

• 3-Way charging pipe (Split type only)

Refrigerating connection is possible in three directions.

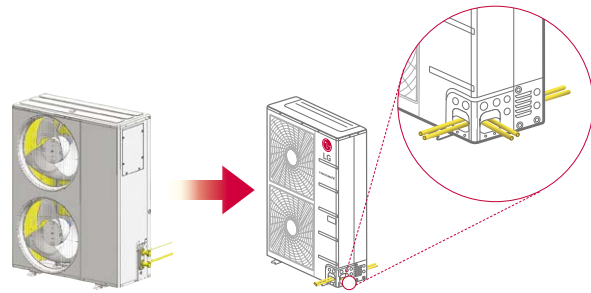

• Compact design & Ez SVC

- Remove 3 pieces of screw for SVC
- Front panel removal system

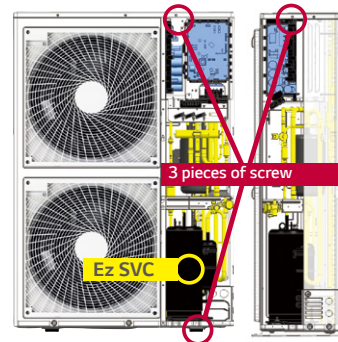

Compact & Slim

Therma V is shaped to minimize the size and weight in order to help easy and efficient work condition for installation.

SPLIT TYPE (16kW)

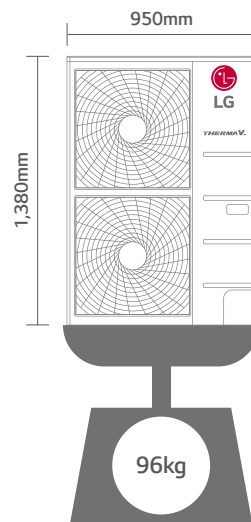

MONOBLOC TYPE (3kW)

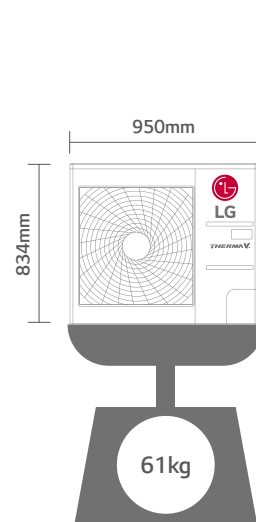

HIGH TEMPERATURE



HIGH TEMPERATURE

Quick Defrosting

Through R134A compressor controlling technology, necessary time for defrost operation has been minimized effectively. (LG Patent)

As compared to normal reverse cycle defrost, 25% reduction in defrost time, and 10% increase of integrated heating capacity is achieved using hybrid defrosting.

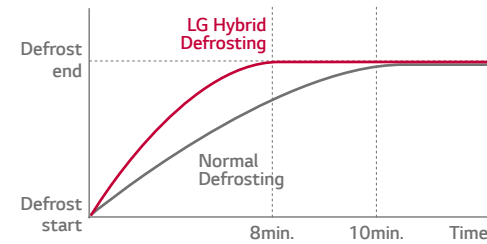
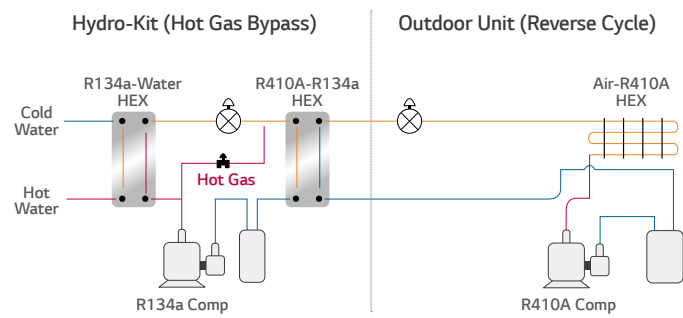

Higher Energy Efficiency

By applying efficient compressor and optimally designed structure, the more energy saving, the lower operating cost make sooner return on initial investment.

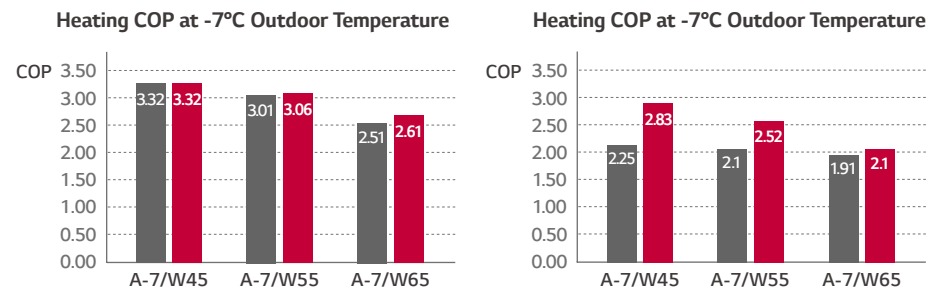

Low Noise Level

Through cutting edge technology for DC inverter compressor, operating noise level of indoor & outdoor unit has been reduced and serves more comfort.

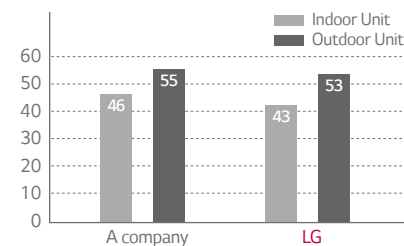

Enhanced Efficiency & Performance

THERMA V high temp. can produce Max. 80°C hot water with high efficiency (Max. COP 4.06 at 24°C ODT & 40/45 EWT/LWT) through cascade 2 stage compression technology.

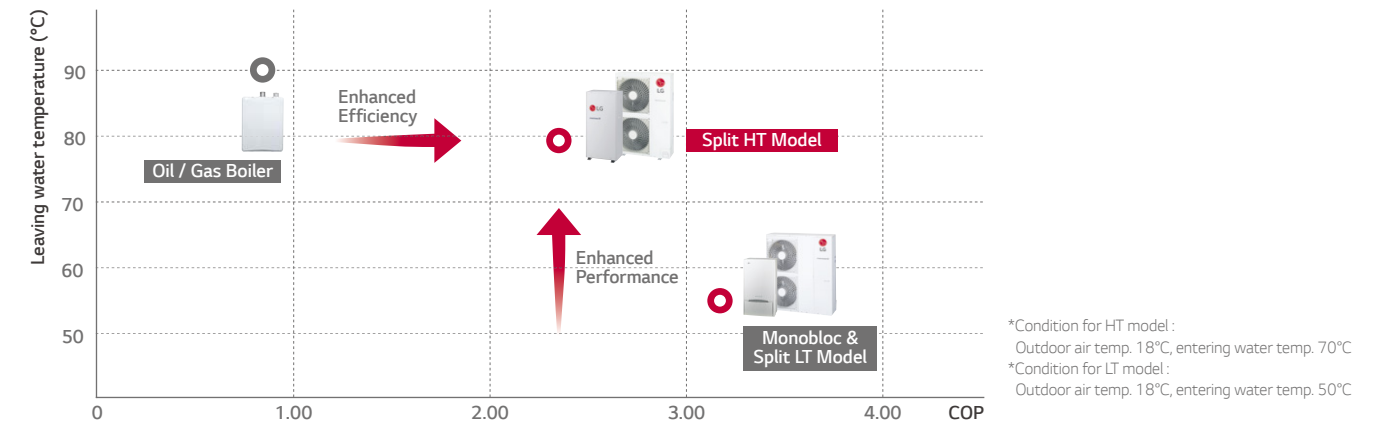

Cascade 2 Stage Compression Technology

Max. 80°C hot water can be generated through Cascade R410A to R134a BLDC compressor technology and is applicable for existing old boiler heating system which demands hot water supply.

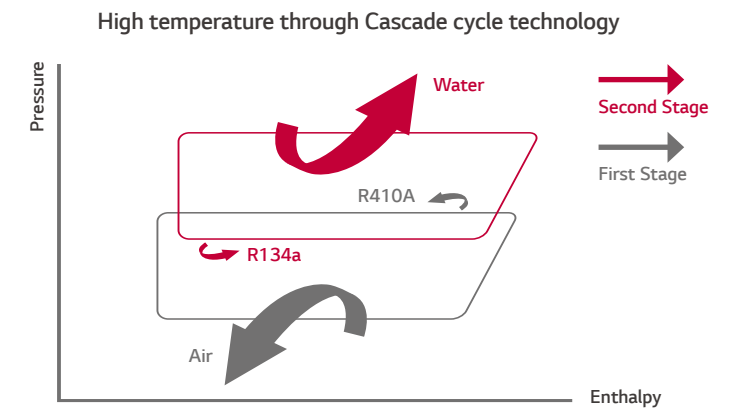

Low Maximum Current Level

LG High Temperature THERMA V can be easily installed without any incurring any additional costs to the electric connections.

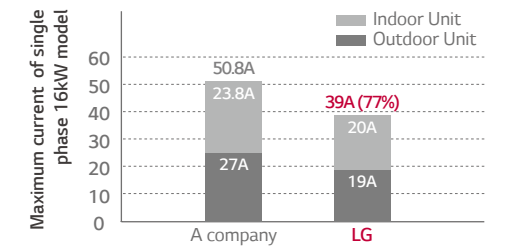

DHW TANK INTEGRATED



THERMA V KEY FEATURES

SPLIT DHW TANK INTEGRATED

Save space & Save time

Compared with conventional system, easy & quick installation is possible and smaller spaces are required for installation.

Conventional	New (DHW tank integrated type)
<ul style="list-style-type: none"> - Enough rooms for product installation - Need to secure the space for water tank - More water piping work & More installation time 	<ul style="list-style-type: none"> All in one Small space for product installation Less water piping work More easy & Save time

2nd Heating Circuit

Possible heating individually through separate heating circuits with a controller and a mixing valve.

Conventional	New
<p>Only 1 heating circuit not individually controllable</p>	<p>Basically 2 heating circuits with individual control</p> <p>With the circuit extension module, max 4 heating circuits to control individually (option, available in 1Q, 2018)</p>

Controller for convenient control

Easy & convenient setting room temperature!

Default controller installed	Option controller installed
<p>Must move to control</p>	<p>It is not required to move it once it has been set up in your room.</p> <p>Room controller Thermostat without display Basic settings of room temperature</p>

SPLIT DHW TANK INTEGRATED

HN1616T.NBO



HN1616T.NBO / HU091.U43, HU121.U33, HU141.U33, HU161.U33



HEATING

SPLIT (INDOOR UNIT)			Capacity	16kW 1/3Ø
			Reference	HN1616T.NBO
Dimensions	W x H x D	mm	607 x 2,079 x 25	
Weight		kg	228	
DHW Tank	Water volume	L	200	
	Buffer volume	L	40	
	Maximum water temperature	°C	95	
	Maximum water pressure	bar	10	
	Insulation	Material	-	Polyurethane foam
	Thickness	mm	50	
	Heat loss (for 24hr)	kWh	1.67	
Buffer Tank	Water volume	L	40	
	Material	-	Steel powder coated	
	Insulation Material	-	Closed cell foamed rubber	
Water Pump	Model	-	Yonos PARA RS25/7 PWM1	
	Motor type	-	BLDC	
	Steps of speed	EA	Variable speed 13% to 100%	
	Power Input	W	3 - 45	
	Water Flow Rate	Min. L / min	16	
	Rated L / min	40		
	Pressure drop Max. kPa	70		
Heat Exchanger (Water Side)	Type	-	Braze Plate HEX	
	Quantity	-	1	
	Water Volume	L	3.3	
	Water Flow Rate (Min. - Max.)	bar	13 - 70	
	Insulation Material	-	Closed cell foamed rubber	
Safety Valve	Pressure Limit Max. Bar	3		
	Refrigerant Circuit	Gas (Outer Dia.) mm(inch)	Ø 15.88 (5/8)	
	Liquid (Outer Dia.) mm(inch)	Ø 9.52 (3/8)		
Piping Connection	Water Circuit	Inlet (Inner Dia.) mm(inch)	Male PT 25 (1)	
		Outlet (Inner Dia.) mm(inch)	Male PT 25 (1)	
	DHW Tank Water Circuit	Cold Inlet (Outer Dia.) mm(inch)	Male PT 19.05 (3/4)	
		Hot Outlet (Outer Dia.) mm(inch)	Male PT 25 (1)	
		Recirculation (Outer Dia.) mm(inch)	Male PT 19.05 (3/4)	
Operation Range	Heating Water side Min.-Max. °C	25-58		
	Cooling Water side Min.-Max. °C	7-25		
	Domestic hot water Water side Min.-Max. °C	25-52 (60*)		
Sound Power Level	Nom. dBA	36		

SPLIT (OUTDOOR)			Capacity	9kW 1Ø	12kW 1Ø	14kW 1Ø	16kW 1Ø	12kW 3Ø	14kW 3Ø	16kW 3Ø
			Reference	HU091.U43	HU121.U33	HU141.U33	HU161.U33	HU123.U33	HU143.U33	HU163.U33
Nominal Capacity	Heating (A7 / W35)	kW	9	12	14	16	12	14	14	16
	Cooling (A35 / W18)	kW	9	10.4	11	12	10.4	11	11	12
Nominal Power Input	Heating (A7 / W35)	kW	2.23	2.78	3.43	4.18	2.78	3.43	3.43	4.18
	Cooling (A35 / W18)	kW	2.88	3.3	3.53	4	3.3	3.53	4	4
COP	Heating (A7 / W35)		4.04	4.32	4.08	3.83	4.32	4.08	4.08	3.83
EER	Cooling (A35 / W18)		3.12	3.15	3.12	3	3.15	3.12	3	3
	General	SCOP	2.88	3	3	3	3	3	3	3
Space heating	Average climate water outlet 55°C (A++ to G Scale)	General	η _s (Seasonal space heating efficiency) %	112	117	117	117	117	117	117
			Seasonal space heating eff. Class	A+	A+	A+	A+	A+	A+	A+
	Average climate water outlet 35°C (A++ to G Scale)	General	SCOP	4.04	4.2	4.15	4.15	4.2	4.15	4.15
			η _s (Seasonal space heating efficiency) %	159	165	163	163	165	163	163
Domestic Hot Water Heating	Average climate (A to G Scale)	General	Declared load profile	XL	XL	XL	XL	XL	XL	XL
			η _{wh} (water heating efficiency) %	98	89	89	89	89	89	89
Dimensions	Unit	W x H x D	mm	834x950x330			1,380 x 950 x 330			
	Shipping	W x H x D	mm	900x1140x461			1,462 x 1,140 x 461			
Weight	Net	kg	59	94	94	94	94	94	94	94
	Gross	kg	65	107	107	107	107	107	107	107
Operation Range	Heating	Min. ~ Max. °C	-20 - 35	-20 - 35	-20 - 35	-20 - 35	-20 - 35	-20 - 35	-20 - 35	-20 - 35
	Cooling	Min. ~ Max. °C	5 - 48	5 - 48	5 - 48	5 - 48	5 - 48	5 - 48	5 - 48	5 - 48
	Domestic hot water	Min. ~ Max. °C	-20 - 30	-20 - 30	-20 - 30	-20 - 30	-20 - 30	-20 - 30	-20 - 30	-20 - 30
Refrigerant	Type	-	R410a			R410a				
	GWP	-	2,087.50			2,087.50				
	Charge	TCO _{2eq}	3.76	4.8	4.8	4.8	4.8	4.8	4.8	
	Chargeless-Pipe Length	m	1.8	2.3	2.3	2.3	2.3	2.3	2.3	
		Additional Charging Volume	g/m	7.5			7.5			
Sound Power Level	Heating	Nom. dBA	65	66	66	66	66	66	66	
	liquid	Type	-	Flare			Flare			
Piping Connections	Outer Dia. mm (inch)	Gas	Ø 9.52(3/8)			Ø 9.52(3/8)				
		Flare	Ø 15.88(5/8)			Ø 15.88(5/8)				
Piping Length	Min. m	3			3					
	Standard m	7.5			7.5					
	Max. m	50			50					
Piping Level Difference	Outdoor Unit - Indoor Unit	Max. m	30			30				
Power supply	Phase/Frequency/Voltage	Hz/V	1-/50/220-240			3-/50/380-415				
Current	Recommended fuses	A	30	40	40	40	40	20	20	
Modbus Converter (*Required purchase separately)	Type	-	Gateway PI485			Gateway PI485				
	Model	-	PP485B00K			PP485B00K				

* with integrated electrical heater

* This product contains fluorinated greenhouse gases. (R410A) / All models do have electric heating cable for prevent frost from condensing water at the condensing pan.
 * All specification is based on EN14511 and EN14825. * Above table values does include humidification effect in the outdoor temperature below zero.

MONOBLOC

HM051M.U42 / HM071M.U42 / HM091M.U42



LG participates in the ECP programme for EUROVENT EURO-HP program. Check ongoing validity of certification: www.eurovent-certification.com



HM121M.U32 / HM141M.U32 / HM161M.U32
HM123M.U32 / HM143M.U32 / HM163M.U32



LG participates in the ECP programme for EUROVENT EURO-HP program. Check ongoing validity of certification: www.eurovent-certification.com



MONOBLOC (OUTDOOR UNIT)		Capacity Reference	5kW 1Ø	7kW 1Ø	9kW 1Ø
			HM051M.U42	HM071M.U42	HM091M.U42
Nominal Capacity	Heating (A7 / W35)	kW	4.99	7.00	9.00
	Heating (A2 / W50)	kW	3.63	5.08	6.18
	Heating (A-2 / W50)	kW	3.59	5.02	6.46
	Heating (A-7 / W35)	kW	3.68	5.16	6.97
	Cooling (A35 / W18)	kW	4.99	5.60	8.80
Nominal Power Input	Heating (A7 / W35)	kW	1.13	1.63	2.20
	Heating (A2 / W50)	kW	1.46	2.15	2.85
	Heating (A-2 / W50)	kW	1.52	2.16	2.78
	Heating (A-7 / W35)	kW	1.54	2.21	2.99
	Cooling (A35 / W18)	kW	1.38	1.55	2.32
COP	Heating (A7 / W35)		4.42	4.29	4.09
	Heating (A2 / W50)		2.49	2.36	2.17
	Heating (A-2 / W50)		2.36	2.32	2.32
	Heating (A-7 / W35)		2.39	2.33	2.33
EER	Cooling (A35 / W18)		3.62	3.61	3.79
Dimension	W x H x D	mm	1,239 x 907 x 390	1,239 x 907 x 390	1,239 x 907 x 390
Weight		kg	97	98	99
Sound Power Level (Heating)		dB (A)	66	66	66
Outdoor Air Operation Range	Heating	°C DB		-20 - 35	
	Cooling	°C DB		5 - 48	
Leaving Water Temp. Range	Heating	°C		15 - 57	
	Cooling	°C		6 - 30	
Water Pipe Connection	Inlet	mm (inch)			
	Outlet	mm (inch)			
Electric Heater	Power Supply	P / V / Hz		1 / 220-240 / 50	
	Capacity	kW		4	
Water Flowrate Limit		LPM			
Max. Water Head		m		7	
Power Supply		P / V / Hz			
Recommended Fuse		A		20	
Refrigerant (R410a)	Pre-Charged Amount	kg	1.20	1.45	1.60
	GWP	TCO ₂ eq	2.50	3.02	3.34
Seasonal space heating energy efficiency class (A++ to G Scale)	35°C / 55°C		A++ / A+	A++ / A+	A++ / A+
Seasonal space heating energy efficiency (average)	35°C / 55°C	%	160 / 110	155 / 112	161 / 114
Rated heat output (average)	35°C / 55°C	kW	6 / 5	7 / 6	7 / 7
Annual energy consumption (average)	35°C / 55°C	kWh	3,119 / 3,707	3,631 / 4,641	3,761 / 4,638
Water pump EEI ≤			0.20	0.20	0.20

* This product contains fluorinated greenhouse gases (R410A)
 * All models do have electric heating cable for prevent frost from condensing water at the condensing pan.
 * Above table values does include humidification effect in the outdoor temperature below zero.
 * All specification is based on EN14511 and EN14825.
 * EHPA label for Germany, Austria and Switzerland.

MONOBLOC (OUTDOOR UNIT)		Capacity Reference	12kW 1Ø	14kW 1Ø	16kW 1Ø	12kW 3Ø	14kW 3Ø	16kW 3Ø
			HM121M.U32	HM141M.U32	HM161M.U32	HM123M.U32	HM143M.U32	HM163M.U32
Nominal Capacity	Heating (A7 / W35)	kW	12.00	14.00	16.00	12.00	14.00	16.00
	Heating (A2 / W50)	kW	8.76	10.41	11.58	8.94	10.43	12.21
	Heating (A-2 / W50)	kW	8.63	10.33	11.45	8.84	10.31	12.07
	Heating (A-7 / W35)	kW	8.27	9.80	10.98	8.29	9.64	11.19
	Cooling (A35 / W18)	kW	10.40	12.20	13.20	10.40	12.20	13.20
Nominal Power Input	Heating (A7 / W35)	kW	2.67	3.15	3.81	2.67	3.15	3.81
	Heating (A2 / W50)	kW	3.51	4.26	4.83	3.65	4.32	5.12
	Heating (A-2 / W50)	kW	3.57	4.45	5.05	3.75	4.45	5.25
	Heating (A-7 / W35)	kW	2.97	3.57	4.30	2.95	3.50	4.39
	Cooling (A35 / W18)	kW	2.67	3.32	3.65	2.67	3.32	3.65
COP	Heating (A7 / W35)		4.49	4.44	4.20	4.49	4.44	4.20
	Heating (A2 / W50)		2.50	2.44	2.40	2.45	2.41	2.38
	Heating (A-2 / W50)		2.42	2.32	2.27	2.36	2.32	2.30
	Heating (A-7 / W35)		2.78	2.75	2.55	2.81	2.75	2.55
EER	Cooling (A35 / W18)		3.90	3.67	3.62	3.89	3.67	3.62
Dimension	W x H x D	mm			1,239 x 1,450 x 390			
Weight		kg		141		145		
Sound Power Level (Heating)		dB (A)			68			
Outdoor Air Operation Range	Heating	°C DB			-20 - 35			
	Cooling	°C DB			5 - 48			
Leaving Water Temp. Range	Heating	°C			15 - 57			
	Cooling	°C			6 - 35			
Water Pipe Connection	Inlet	mm (inch)			Female 25.4 (1)			
	Outlet	mm (inch)			Female 25.4 (1)			
Electric Heater	Power Supply	P / V / Hz		1 / 220-240 / 50		3 / 380-415 / 50		
	Capacity	kW			6			
Water Flowrate Limit		LPM			Min.15			
Max. Water Head		m			8			
Power Supply		P / V / Hz		1 / 220-240 / 50		3 / 380-415 / 50		
Recommended Fuse		A		32		20		
Refrigerant (R410a)	Pre-Charged Amount	kg			2.20			
	GWP	TCO ₂ eq			4.59			
Seasonal space heating energy efficiency class (A++ to G Scale)	35°C / 55°C		A++ / A+	A++ / A+	A++ / A+	A++ / A+	A++ / A+	A++ / A+
Seasonal space heating energy efficiency (average)	35°C / 55°C	%	166 / 121	166 / 121	164 / 121	174 / 124	164 / 124	163 / 124
Rated heat output (average)	35°C / 55°C	kW	11 / 10	12 / 10	12 / 10	11 / 11	12 / 11	11 / 13
Annual energy consumption (average)	35°C / 55°C	kWh	5,536 / 6,698	5,819 / 6,698	6,094 / 6,698	5,812 / 7,078	5,922 / 7,078	6,210 / 7,078
Water pump EEI ≤			0.23	0.23	0.23	0.23	0.23	0.23

* This product contains fluorinated greenhouse gases (R410A)
 * All models do have electric heating cable for prevent frost from condensing water at the condensing pan except 3kW capacity.
 * Above table values does include humidification effect in the outdoor temperature below zero.
 * All specification is based on EN14511 and EN14825.
 * EHPA label for Germany, Austria and Switzerland. * EHPA label is not include 12/14/16kW single phase type.

SPLIT

HN1616.NK3 / HU051.U43, HU071.U43, HU091.U43



LG participates in the ECP programme for EUROVENT EURO-HP program. Check ongoing validity of certification: www.eurovent-certification.com



SPLIT (OUTDOOR UNIT)		Capacity Reference	5kW Ø HU051.U43	7kW 1Ø HU071.U43	9kW 1Ø HU091.U43
Nominal Capacity	Heating (A7 / W35)	kW	5.00	7.00	9.00
	Heating (A2 / W35)	kW	4.30	5.97	7.30
	Heating (A-2 / W50)	kW	6.24	6.68	7.08
	Heating (A-7 / W35)	kW	4.23	5.88	7.53
	Cooling (A35 / W18)	kW	5.00	7.00	9.00
Nominal Power Input	Heating (A7 / W35)	kW	1.01	1.59	2.05
	Heating (A2 / W35)	kW	3.52	1.70	2.09
	Heating (A-2 / W50)	kW	3.20	3.34	3.54
	Heating (A-7 / W35)	kW	2.78	2.14	2.74
	Cooling (A35 / W18)	kW	1.09	1.56	2.37
COP	Heating (A7 / W35)		4.93	4.80	4.40
	Heating (A2 / W35)		3.52	3.51	3.50
	Heating (A-2 / W50)		1.95	2.00	2.00
	Heating (A-7 / W35)		2.78	2.75	2.75
EER	Cooling (A35 / W18)		4.60	4.50	3.80
Dimension	W x H x D	mm	950 x 834 x 330		
Weight		kg	60		
Sound Pressure Level (Heating)		dB(A)	-		
Sound Power Level (Heating)		dB(A)	65		
Outdoor Air Operation Range	Heating	°C DB	-20 ~ 35		
	Cooling	°C DB	5 ~ 48		
Refrigerant (R410a)	Pipe Diameter (Liquid)	mm (inch)	9.52 (3/8)		
	Pipe Diameter (Gas)	mm (inch)	15.88 (5/8)		
	Pre-charged Amount	kg	1.55		
		TCO ₂ eq	3.24		
	GWP		2087.5		
	Chargeless Pipe Length	m	7.5		
Ref. Pipe Length	Additional Charging Volume	g/m	40		
	Minimum	m	3		
	Standard	m	7.5		
Maximum	m	50			
Power Supply	P / V / Hz		1 / 220-240 / 50		
Recommended Fuse	A		20		

* This product contains fluorinated greenhouse gases. (R410A) / All models do have electric heating cable for prevent frost from condensing water at the condensing pan.
 * All specification is based on EN14511 and EN14825. * Above table values does include humidification effect in the outdoor temperature below zero.

SPLIT (INDOOR UNIT)		Capacity Reference	5,7,9kW HN1616.NK3		
Dimension	W*H*D	mm	490 x 850 x 315		
Weight		kg	42		
Electric Heater	Power Supply	P/V/Hz	1 / 220-240 / 50		
	Capacity	kW	6		
Leaving Water Temp. Range	Heating	°C	15 ~ 57		
	Cooling	°C	6 ~ 30		
Water Flowrate Limit		LPM	Min 15.		
Max. Water Head		m	7		
Water Pipe Connection	Inlet	mm(inch)	Male PT 25 (1)		
	Outlet	mm(inch)	Male PT 25 (1)		
Energy Efficiency Class Seasonal Space Heating (A++ to G Scale)	35°C / 55°C		4.52 / 3.23	4.45 / 3.23	4.34 / 3.23
Seasonal Space Heating Energy Efficiency (Average)	35°C / 55°C	%	178 / 126	175 / 126	171 / 126
Rated Heat Output (kW)	35°C / 55°C	kW	6 / 6	6 / 6	7 / 6
Annual Energy Consumption (Average)	35°C / 55°C	kWh	2,512 / 3,581	2,783 / 3,581	3,093 / 3,581
Water Pump EEI			0.23	0.23	0.23

HN1616.NK3 / HU121.U33, HU141.U33, HU161.U33 HN1639.NK3 / HU123.U33, HU143.U33, HU163.U33



LG participates in the ECP programme for EUROVENT EURO-HP program. Check ongoing validity of certification: www.eurovent-certification.com



SPLIT (OUTDOOR UNIT)		Capacity Reference	12kW 1Ø HU121.U33	14kW 1Ø HU141.U33	16kW 1Ø HU161.U33	12kW 3Ø HU123.U33	14kW 3Ø HU143.U33	16kW 3Ø HU163.U33
Nominal Capacity	Heating (A7 / W35)	kW	12.00	14.00	16.00	12.00	14.00	16.00
	Heating (A2 / W35)	kW	10.33	10.83	11.95	10.33	10.83	11.95
	Heating (A-2 / W50)	kW	11.89	11.89	11.89	11.89	11.89	11.89
	Heating (A-7 / W35)	kW	11.00	12.50	13.50	11.00	12.50	13.50
	Cooling (A35 / W18)	kW	10.40	12.00	13.00	10.40	12.00	13.00
Nominal Power Input	Heating (A7 / W35)	kW	2.64	3.17	3.76	2.64	3.17	3.76
	Heating (A2 / W35)	kW	2.93	3.09	3.41	2.93	3.09	3.41
	Heating (A-2 / W50)	kW	5.25	5.25	5.25	5.25	5.25	5.25
	Heating (A-7 / W35)	kW	3.14	3.73	4.35	3.14	3.73	4.35
	Cooling (A35 / W18)	kW	2.60	3.08	3.60	2.60	3.08	3.60
COP	Heating (A7 / W35)		4.55	4.41	4.26	4.55	4.41	4.26
	Heating (A2 / W35)		3.52	3.51	3.50	3.52	3.51	3.50
	Heating (A-2 / W50)		2.27	2.27	2.27	2.27	2.27	2.27
	Heating (A-7 / W35)		3.50	3.35	3.10	3.50	3.35	3.10
EER	Cooling (A35 / W18)		4.00	3.90	3.61	4.00	3.90	3.61
Dimension	W x H x D	mm	950 x 1,380 x 330					
Weight		kg	94					
Sound Pressure Level (Heating)		dB(A)	-					
Sound Power Level (Heating)		dB(A)	66					
Outdoor Air Operation Range	Heating	°C DB	-20 ~ 35					
	Cooling	°C DB	5 ~ 48					
Refrigerant (R410a)	Pipe Diameter (Liquid)	mm (inch)	9.52 (3/8)					
	Pipe Diameter (Gas)	mm (inch)	15.88 (5/8)					
	Pre-charged Amount	kg	2.30					
		TCO ₂ eq	4.80					
	GWP		2087.5					
	Chargeless Pipe Length	m	7.5					
Ref. Pipe Length	Additional Charging Volume	g/m	60	60	60	50	50	50
	Minimum	m	3					
	Standard	m	7.5					
Maximum	m	50						
Power Supply	P / V / Hz		1 / 220-240 / 50	1 / 220-240 / 50	1 / 220-240 / 50	3 / 380-415 / 50	3 / 380-415 / 50	3 / 380-415 / 50
Recommended Fuse	A		40					

* This product contains fluorinated greenhouse gases. (R410A) / All models do have electric heating cable for prevent frost from condensing water at the condensing pan.
 * All specification is based on EN14511 and EN14825. * Above table values does include humidification effect in the outdoor temperature below zero.

SPLIT (INDOOR UNIT)		Capacity Reference	12 ~ 16kW 1Ø HN1616.NK3			12 ~ 16kW 3Ø HN1639.NK3		
Dimension	W x H x D	mm	490 x 850 x 315					
Weight		kg	42			43		
Electric Heater	Power Supply	P / V / Hz	1 / 220-240 / 50			3 / 380-415 / 50		
	Capacity	kW	6			9		
Leaving Water Temp. Range	Heating	°C	15 ~ 57					
	Cooling	°C	6 ~ 30					
Water Flowrate Limit		LPM	Min 15.					
Max. Water Head		m	7			7		
Water Pipe Connection	Inlet	mm (inch)	Male PT 25 (1)					
	Outlet	mm (inch)	Male PT 25 (1)					
Energy Efficiency Class Seasonal Space Heating (A++ to G Scale)	35°C / 55°C		A++ / A++					
Seasonal Space Heating Energy Efficiency (Average)	35°C / 55°C	%	4.45 / 3.32	4.45 / 3.32	4.30 / 3.32	4.45 / 3.32	4.45 / 3.32	4.30 / 3.32
Rated Heat Output (kW)	35°C / 55°C	kW	9 / 10	10 / 10	10 / 10	9 / 10	10 / 10	10 / 10
Annual Energy Consumption (Average)	35°C / 55°C	kWh	4,177 / 6,154	4,408 / 6,154	4,802 / 6,154	4,177 / 6,154	4,408 / 6,154	4,802 / 6,154
Water Pump EEI			0.23	0.23	0.23	0.23	0.23	0.23

HIGH TEMPERATURE

HN1610H.NK2
HU161H.U32



LG participates in the ECP programme for EUROVENT EURO-HP program.
Check ongoing validity of certification :
www.eurovent-certification.com



HIGH TEMP. SLIT (OUTDOOR UNIT)		Capacity Reference	16kW 1Ø HU161H.U32
Nominal Capacity	Heating (A7 / W65)	kW	16.00
	Heating (A2 / W65)	kW	14.60
	Heating (A-2 / W65)	kW	15.70
	Heating (A-7 / W65)	kW	15.10
Nominal Power Input	Heating (A7 / W35)	kW	16.00
	Heating (A7 / W65)	kW	6.13
	Heating (A2 / W65)	kW	6.81
	Heating (A-2 / W65)	kW	6.96
	Heating (A-7 / W65)	kW	7.20
	Heating (A7 / W35)	kW	4.70
	Heating (A7 / W65)	kW	2.61
COP	Heating (A2 / W65)		2.14
	Heating (A-2 / W65)		2.25
	Heating (A-7 / W65)		2.09
	Heating (A7 / W35)		3.40
Dimension	W x H x D	mm	950 x 1,380 x 330
Weight		Kg	105
Sound Power Level (Heating)		dB (A)	68
Outdoor Air Operation Range	Heating	°C DB	-15 - 35
Refrigerant (R410a)	Pipe Diameter (Liquid)	mm (inch)	9.52 (3/8)
	Pipe Diameter (Gas)	mm (inch)	15.88 (5/8)
	Pre-Charged Amount	kg	3.5
		TCO ₂ eq	7.3
	GWP		2,087.5
	Chargeless Pipe Length	m	10
Ref. Pipe Length	Additional Charging Volume	G/m	60
	Minimum	m	5
	Standard	m	7.5
Power Supply	Maximum	m	50
		P / V / Hz	1 / 220-240 / 50
Recommended Fuse	A		25

* This product contains fluorinated greenhouse gases. (R410A)
* All specification is based on EN14511 and EN14825

HIGH TEMP. SLIT (INDOOR UNIT)		Capacity Reference	16kW 1Ø HN1610H.NK2
Dimension	W x H x D	mm	520 x 1,080 x 330
Weight		kg	94
Sound Power Level (Heating)		dB (A)	57
Nominal Power Input	Heating	kW	6.13
Leaving Water Temp. Range	Heating	°C	25 - 80
Water Flowrate Limit		LPM	Min.15
Refrigerant (R134a)	Pipe Diameter (Liquid)	mm (inch)	9.52 (3/8)
	Pipe Diameter (Gas)	mm (inch)	15.88 (5/8)
	Pre-Charged Amount	kg	2.3
		TCO ₂ eq	3.3
Water Pipe Connection	GWP		1430
	Inlet	mm (inch)	Male PT 25 (1)
Draining Pipe Connection	Outlet	mm (inch)	Male PT 25 (1)
		mm (inch)	Male PT 25 (1)
Power Supply		P / V / Hz	1 / 220-240 / 50
Recommended Fuse	A		25
Seasonal space heating energy efficiency class (A++ to G Scale)	35°C / 55°C		A / A+
Seasonal space heating energy efficiency (average)	35°C / 55°C	%	115 / 113
Rated heat output (average)	35°C / 55°C	kW	13 / 11
Annual energy consumption (average)	35°C / 55°C	kWh	9,395 / 7,642

DOMESTIC HOT WATER TANK

OSHW-200F
OSHW-300F
OSHW-500F
OSHW-300FD



Domestic Hot Water Tank – Double Coil

DOMESTIC HOT WATER TANK		OSHW-200F	OSHW-300F	OSHW-500F	OSHW-300FD
General Characteristics	Water Volume	L	200	300	500
	Diameter	mm	640	640	810
	Height	mm	1,350	1,850	1,900
	Empty Weight	kg	61	100	146
Characteristics of Electrical Back-up	Tank Materials		F18 S.STEEL	F18 S.STEEL	F18 S.STEEL
	Color		Grey	Grey	Grey
	Additional Electric Heater	W	2,400	2,400	2,400
	Power supply electric heater	Ø / V / Hz	230W / 50 / 60Hz	230W / 50 / 60Hz	230W / 50 / 60Hz
Characteristics of Exchanger	Adjustable Thermostat	°C	0-90	0-90	0-90
	Exchanger Type		Internal Single Coil	Internal Single Coil	Internal Single Coil
	Material Exchanger		F18 S.STEEL	F18 S.STEEL	F18 S.STEEL
	Maximum Water Temperature	°C	90	90	90
Hydraulic Connections – Heat Pump	Coil Surface	mm	2.3	3.1	4.8
	Inlet	mm	1"	1"	1 1/4"
Hydraulic connections – Domestic Hot Water Tank	Outlet	mm	1"	1"	1 1/4"
	Domestic hot water inlet	mm	3/4"	3/4"	1"
Energy Efficiency Class	Domestic hot water outlet	mm	3/4"	1"	1"
			B	B	B
Standing Heat loss	W	61	70	83	
Number of Coil		Single	Single	Single	
MANDATORY OPTIONAL ACCESSORIES					
Domestic Hot Water Tank Installation Kit		PHLTA	PHLTA	PHLTA	PHLTA
OPTIONAL ACCESSORIES					
Mixing Valve		OSHA-MV	OSHA-MV	OSHA-MV	OSHA-MV
3-Way Valve		OSHA-3V	OSHA-3V	OSHA-3V	OSHA-3V

LG Wi-Fi MODEM

Control LG THERMA V via using the internet devices as Android or iOS bases smartphones



PWFMD200

Features

- Access LG THERMA V anytime and from anywhere with Wi-Fi equipped device
- LG's exclusive Home Appliances control app(SmartThinQ) is available
- Simple operation for various functions
 - On/Off
 - Operation Mode
 - Current/Set Temperature

Model Name	PWFMD200
Size (W x H x D, mm)	48 x 68 x 14
Interfaceable Products	THERMA V Split Indoor unit
Connection Type	Indoor unit 1:1
Communication Frequency	2.4 GHz
Wireless Standards	IEEE 802.11b/g/n
Mobile Application	LG Smart ThinQ (Android v4.1(Jellybean) or higher, iPhone iOS 9.0 or higher)
Optional Extension Cable	PWYREW000 (10m extension)

* Functionality may be different according to each IDU model
 * User interface of application shall be revised for its design and contents improvement
 * Application is optimized for smartphone use, so it may not be well functioning with tablet devices
 1) Vane Control may not be possible according to the type of Indoor unit
 2) For the compatibility with Indoor unit, please contact regional office

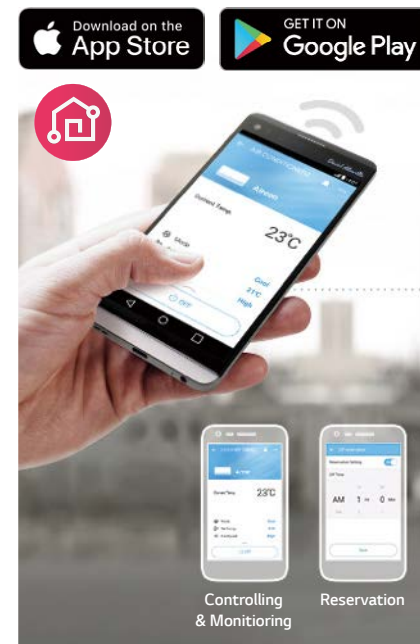

Overview

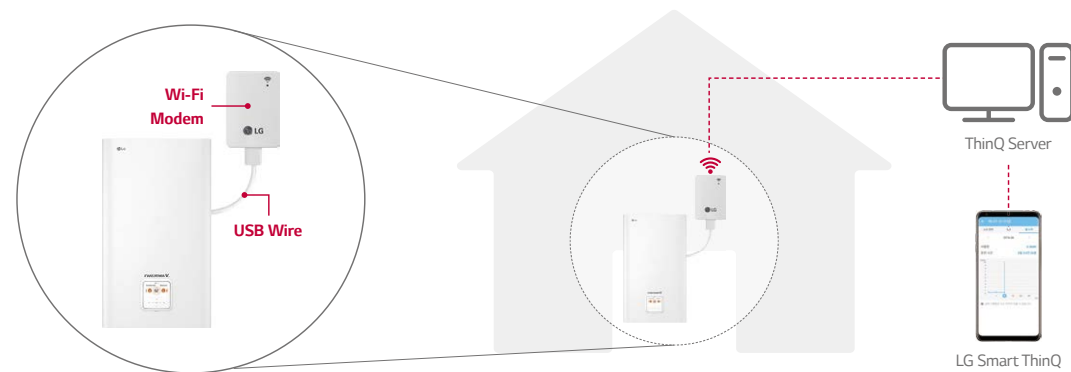

* Search "LG Smart ThinQ" on Google market or Appstore then download the app.
 * Internet service with Wi-Fi connection has to be available

Wi-Fi CONTROLLER

LG-AW-WF-1



Features

- External Power is not required
- Single system unit capacity (Monobloc, Split Low/High Temp)
- Control and monitor by mobile device
- Additional internet service has to be available and registration user account in IntesisHome cloud to use Wi-Fi controller is mandatory
- IntesisHome cloud application is available for smart devices such as smart phone(Android, iOS), laptop, tablet.

Model Name	LG-AW-WF-1
Start / Stop Operation	0
Operation Mode	Heating / Heating & DHW / Cooling & DHW / Cooling / DHW
Set Point	0
Ambient Temperature	0
Fan Speed	0

Specifications

Model Name	LG-AW-WF-1
Enclosure	ABS (UL 94 HB), 2.5 mm thickness
Dimensions (mm)	70 x 108 x 28 mm
Weight (g)	80g
Color	White
Power Supply	12V, 60mA typical Doesn't require external power supply (supplied by the Indoor Unit)
Mounting	Wall
Operating Temperature	From 0°C to 40°C
Operating Humidity	<93% HR, no condensation
Stock Humidity	<93% HR, no condensation
RoHS Conformity	Compliant with RoHS directive (2002/95/CE)
Certifications	CE conformity to EMC directive (2004/108/EC), Low-voltage directive (2006/95/EC) EN 60950-1 / EN301489-1 v1.8.1 / EN 301489-17 v2.1.1



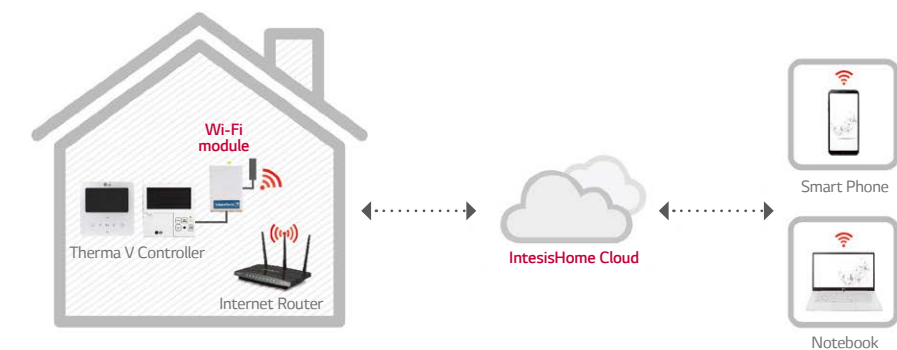







Overview



















1) This product is provided by Intesis.

ACCESSORIES

Accessories Provided by LG

Accessory	Feature
Domestic Hot Water Tank	 <ul style="list-style-type: none"> OSHW-200F 200 LITRES OSHW-300F 300 LITRES OSHW-500F 500 LITRES  <ul style="list-style-type: none"> OSHW-300FD 300 LITRES  OSHA-3V  OSHA-MV
Domestic Hot Water Tank Kit	<ul style="list-style-type: none"> • PHLTA (1Ø, Split) • PHLTC (3Ø, Split) • PHLTB (Monobloc) <p>Features Easy to install the domestic hot water for monobloc. There is a MCCB to protect the product. Dimension (mm) (H x W x D): 250 x 170 x 110 Weight (kg): 2.1</p> <p>To extend THERMA V functionality in generating domestic hot water.</p> <p>* PHLTA, PHLTC is required only when you want to use the electric heater function at the sanitary tank. If not, it's not necessary. THERMA V indoor unit it self already has electric heater (back up heating) function.</p> <p>* The sensor (PHRSTA0) can be purchased separately in case of using other brand's Domestic tank.</p>  PHLTA / PHLTC  PHLTB
Remote Temperature Sensor	<ul style="list-style-type: none"> • PQRSTA0 <p>Features It can help to detect the exact room temperature. Applied to ceiling cassette, ceiling concealed duct, AWHP and Hydro Kit.</p> <p>Parts Included Remote temperature sensor / Extension cable (15m) / Manual</p> 
Solar Thermal Kit	<ul style="list-style-type: none"> • PHLLA <p>Features To interface solar-thermal system with THERMA V and double coil Domestic tank. Installed at the water pipe, between Domestic tank and solar-thermal system. Dimension (mm) (H x W x D): 110 x 55 x 22</p> 
Dry Contact	<ul style="list-style-type: none"> • PDRYCB000 <p>Features For connection with boiler (Bivalent scene)</p> 
Drain Pan	<ul style="list-style-type: none"> • PHDPB <p>Features Collects condensate water (When dropping to the base is not possible) and drains the water to a pipe</p> 

Recommended Optional Accessories

No.	Accessory	Picture	Purpose	Specification
1	Domestic Hot Water Tank		Store and provide hot water for sanitation	Volume : 200 - 400 l Enameld or stainless-steel tank / Insulating foam (e.g. PUR - polyurethane) heat-exchanger surface $\geq 3 \text{ m}^2$
2	3-Way-Valve		Switch between heating and domestic hot water circuit	230V AC SPDT (Single Pole Double Throw) / opening time 30 - 90 sec / final position switch Internal leakage rate $< 0,1\%$
3	Electrical Tank Heater		Supports heating of domestic hot water, when heat pump is blocked or capacity is limited	2 - 6 kW Connector dimension suitable for DHW tank
4	Buffer Tank		Prevents cycling, when water volume is low and /or heating demand is low, secures enough heat for defrosting cycle	Insulating foam (e.g. PUR - polyurethane) Volume : 100 - 200 l (Installation in series with heat pump) 500 - 1,000 l (Installation in parallel with heat pump)
5	Bypass Valve		Ensures minimum water flow rate, when flow through heating circuits is limited due to closed valves	Dimensioning according manufacturer adjustable opening pressure
6	2-Way-Valve		Blocks heating circuits, that are not suitable for cooling during cooling operation	230V AC NO or NC type final position switch
7	Expansion Vessel		Absorption of pressure differences in the heating circuits due to temperature increase / decrease of the water	Dimensioning on-site required
8	Strainer		Protects plate-heat-exchanger from blocking particles	1 inch / 25.4mm, Mesh size $\sim 1 \times 1 \text{ mm}$ for HM03M1.U42 only (other models are included)
9	Heating Cable		Prevents the condensate pan and the drainage pipe from icing	Thermostatic control depending on outdoor temperature All models do have electric heating cable for prevent frost from condensing water at the condensing pan except 3kW capacity.
10	Antifreeze		Prevents the heating water from freezing, when heat pump is out of order	Monoethyleneglycole Concentration according to lowest possible outdoor temperature
11	Noise Damper		Prevents that structure-born noise is transported via the water piping	EPDM; Operating temperature according climate region (at least -10 - +90°C)
12	Anti-Noise Sockets		Prevents that structure-born noise is transported to the base or to the brackets	Dimensioning on-site required
13	Thermostat		When thermostatic room temperature control is preferred by costumer	230V AC When heat pumps operates in heating and cooling mode : thermostat with mode selection
14	Refrigerant Tubes		Pre-fabricated double-pipe to connect split indoor and outdoor unit	Diameter : Please refer to Specification
15	Water Tubes		Pre-fabricated double-pipe to connect monobloc outdoor unit with heating system	When heat pump is used for cooling : diffusion-resistant tubes
16	Bushing Sleeve		Protecting the building against pressing water coming through the duct of the heating tubes	Dimensioning on-site required
17	Insulation Material		Mandatory when heat pump is used for cooling; prevents condensate water on cold pipes and assemblies	Diffusion-resistant

LG LATS THERMA V

THERMA V Selection Program

LATS THERMA V simulates quick and easy result of THERMA V's economic benefits. By specifying a number of parameters, this program shows annual energy cost compared with conventional heating system and CO₂ annual amount, monthly energy amount and cost, total amount of thermal energy in kWh as the outside temperature.

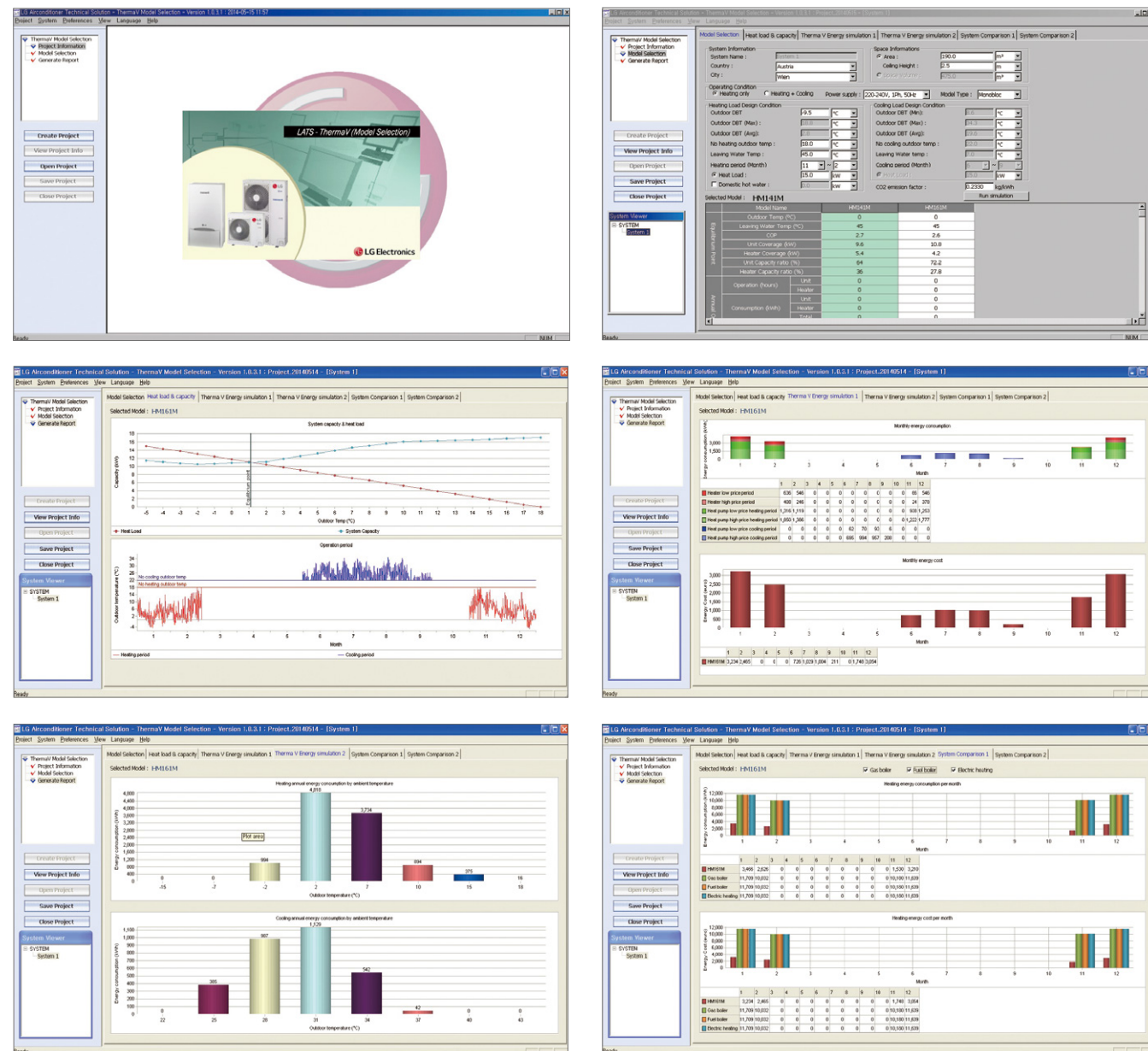

LG THERMA V Micro Web Site

THERMA V microsite where you can do

1. Energy simulation for your home by following 6 simple steps. (<http://www.lgethermav.com>)
2. Able to find LG THERMA V features
3. Locate European Certification information.

